

COLLECTIONS

dvo_

A LIFEFUL PLACE FOR A DESIGNFUL INSTINCT

Design del servizio. Siamo prima di tutto questo. Esperti del settore dell'arredo da ufficio. E innovatori. Partner prima che fornitori. Partecipiamo ai progetti dei clienti fornendo servizi di pre e post-vendita e formazione continua. Puntiamo alla felicità del cliente perché è un concetto che va oltre la semplice soddisfazione. Siamo una service company che risponde a ogni idea creativa con un servizio just in time e una logistica veloce e affidabile. Lavoriamo al fianco di architetti e progettisti per fornire un servizio flessibile, dinamico, a misura di cliente e di progetto. Pensiamo e agiamo "green", implementando continuamente le nostre certificazioni. DVO è soprattutto questo. Un partner capace di interpretare il mercato e comprenderne le evoluzioni. Per fornire le risposte giuste prima che diventino bisogni.

Service design. This is what we are, first and foremost. Experts in the office furniture industry. And innovators. Partners more so than suppliers. We contribute to our customers' projects, providing before- and after-sales services and continuous training. We strive to make our customers happy, because happiness goes well beyond satisfaction. We are a service company that responds to every creative idea with a just-in-time strategy and fast, reliable logistics. We work alongside architects and designers to offer a flexible, dynamic service tailored to the customer and the project. We think and act "green", continuously building on our certifications. DVO is this, above all. A partner able to interpret the market and understand its evolution. To give the right answers before desires become needs.

OUR LIFEFUL PLACE, FOR LIFEFUL PEOPLE



Receptions P. 04

Executives P. 60

Workstations P. 186

Modules System P. 324

Home Office Solutions P. 336

Meet P. 348

Partitions P. 378

Storages P. 418

Accessories P. 520

Index

Receptions

Gli elementi dedicati all'accoglienza. Tre differenti collezioni di mobili da reception per ufficio che si adattano perfettamente ad ogni esigenza: minimalismo, chiarezza costruttiva e linearità.

The elements dedicated to welcoming areas. Three different collections for any need: minimalism, constructive clarity and clean design.

Led P. 06



Abako P. 24



Qubo P. 40



Led

DV702

L'espressione esatta di chiarezza costruttiva. Una linea dedicata all'arredo per reception, funzionale al dialogo e all'operatività. Funge da primo contatto, è l'elemento che relaziona l'utente con l'azienda attraverso una chiarezza lineare ben definita ed elegante.

The precise expression of constructive clarity. A line dedicated to reception furniture, functional to dialogue and operation. It acts as a first contact, it is the element that relates the user to the company through a well-defined and elegant linear clarity.











Ogni dettaglio della collezione è curato nei minimi particolari: delicate rotondità si contrappongono a linee decise.

Every detail of collection is taken care of to the extreme: delicately rounded shapes contrast with clean lines.





Con i suoi pannelli
retroilluminati a led,
i banchi reception
trasformano l'ambiente
circostante
in pura magia.



*With its backlit panels
it transforms the
environment into pure
magic.*



Moduli bancone e fianchi / Reception units and sides

Pannelli verticali sp. 1.8 cm in melaminico (*) o laminato (**)/
Vertical panels 1.8 cm thick in melamine (*) or laminate (**)



Bianco lucido /
Glossy white

Noce "Maroncelli" /
"Maroncelli" walnut

Rovere chiaro /
Light oak

Piani di lavoro sp. 1.8 cm, in melaminico /
Worktops 1.8 cm thick, in melamine



Bianco /
White

Noce "Maroncelli" /
"Maroncelli" walnut

Rovere chiaro /
Light oak

Zoccoli e profili in alluminio /
Base metal frames and profiles in aluminium



Alluminio /
Aluminium

Top sp. 1.5 cm, in vetro temprato retrolaccato /
Top 1.5 cm thick, rear-lacquered tempered glass



Retrolaccato bianco /
Rear lacquered white

Gambe terminali - intermedie in tubolare metallico /
Tubular metal end - intermediate legs



Bianco /
White

Alluminio /
Aluminium

Pannelli Led sp. 0.4 cm, in Metacrilato /
Led panels 0.4 cm thick, in Methacrylate



Opalino bianco + telaio alluminio /
Opal white + aluminium frame

Note

Su specifica richiesta è possibile ordinare abbinamenti tra pannelli e piani di lavoro diversi da quelli previsti a listino. Eventuali richieste di pannelli in metacrilato con illuminazione Led con colorazioni e finiture differenti, verranno valutate di volta in volta dall'ufficio commerciale. / On specific request, front panels, side panels, and worktops can be supplied in non-standard finishes. Requirements for special finishes for the methacrylate Led panels with lighting will be studied case by case by the commercial department.

Moduli bancone standard/Standard counter units

P 85,5 x H 112	L 85,5 P 85,5 x H 112	L 85,5 P 86,5 x H 112
702.MB.11.08_ L 80 702.MB.11.12_ L 120 702.MB.11.18_ L 180 Moduli dritti/Straight counter units	702.MB.13.08_ Raccordo 90° 2 vie /2 Way connection counter unit	702.MB.14.08_ Terminale 90° Dx - Sx /Terminal counter unit 90° R - L

Moduli bancone con Led/Counter units with Led

P 85,5 x H 112	L 85,5 P 85,5 x H 112	L 85,5 P 86,5 x H 112
702.MB.11.08_ + Led L 80 702.MB.11.12_ + Led L 120 702.MB.11.18_ + Led L 180 Moduli dritti/Straight counter units	702.MB.13.08_ + Led Raccordo 90° 2 Vie /2 Way connection counter unit	702.MB.14.08_ + Led Terminale 90° Dx - Sx /Terminal counter unit 90° R - L

Moduli bancone con piano conversazione/Counter units with conversation top

P 105 x H 74	L 82 P 8 x H 73	L 8 P 1 x H 34	L 8 P 1 x H 71,5
702.MB.12.12_ L 120 Modulo conversazione /Conversation counter unit	702.FC.13.08_ Dx - R/Sx - L Fianchi terminali conversazione /Terminal sides for conversation counter units	702.CT.A1.01 Copertura superiore conversazione /Upper cover element for conversation counter unit	702.CT.B1.01 Copertura terminale conversazione /Terminal cover element for conversation counter units

Componenti per bancone/Components for counter units

L 82 P 8 x H 108	L 8 P 1 x H 108
702.FC.11.08_ Fianchi terminali /Terminal sides Dx - R/Sx - L	702.CT.10.01 Copertura terminale /Terminal cover element

Gambe/Legs

Dx/R	Sx/L	702.GM.11.00 Gamba intermedia /Middle leg

Allunghi laterali/Lateral extensions

P 65 x H 74	P 80 x H 74	P 65 x H 1,8
801.TD.01.08_ L 80 801.TD.01.10_ L 100 801.TD.01.12_ L 120	801.TD.02.08_ L 80 801.TD.02.10_ L 100 801.TD.02.12_ L 120	801.AL.01.08_ L 80 801.AL.01.10_ L 100 801.AL.01.12_ L 120

Cassettiere portanti/Carrying pedestals

L 42 P 65 x H 72,2	L 42 P 65 x H 72,2	H 2,5
550.CS.30.04_	550.CS.40.04_	550.CG.11.04 Zoccolo (Optional) /Base frame (Optional)

Cassettiere/Pedestals

L 42 P 57 x H 55,5	L 32,2 P 54,2 x H 55,6	L 42,2 P 54,2 x H 55,6
550.CS.10.04_ Melaminico/Melamine	550.CS.1M.03_ Metalliche/Metallic	550.CS.2M.04_ Metalliche - Vaschetta porta cancelleria inclusa/Metallic - Stationery tray included

Note: Per portacancelleria cassette, vedi capitolo DV300-Accessori / For stationary tray, see chapter DV300-Accessories.

Canalizzazione - Elettificazione/Wire-Management - Electrification

P 10,2 x H 4,5	P 10,2 x H 4,5	L 80 P 10,2 x H 4,5
702.AP.01.08 L 80 702.AP.01.12 L 120 702.AP.01.18 L 180	702.AP.01.07	702.APT.1.08

702.AP.03.01	300.AP.F1.00	702.DM.01.00	702.DM.02.00	702.AL.L6.00 30W/110 - 240V ± 12V	702.AL.L7.00 50W/110 - 240V ± 12V

Bracci porta video/Arms for video support

300.AC.02.01 Braccio porta video mobile su piano /Dynamic arm for video support on deskbase

Note:

- Progettare la composizione del bancone ed aggiungere:
n°1 gamba intermedia per ogni collegamento tra due moduli;
n° 1 gamba terminale Dx o Sx, o fianco terminale Dx o Sx,
o fianco terminale conversazione Dx o Sx per ogni lato finale del
bancone; coperture terminali nella stessa quantità
delle gambe terminali; copertura superiore per ogni collegamento
tra modulo conversazione e modulo bancone;
/ When designing the counter composition, add the following
elements: n°1 middle leg for each connection between
two counters; n°1 terminal leg (RH or LH) or terminal side (RH or LH),
or terminal side for conversation counter unit (RH or LH) on each
side of the counter unit; add the terminal covers elements according
to the same quantity of terminal legs; upper cover element for
the connection between the conversation counter unit and the
standard counter unit;
 - Le dimensioni sono espresse in cm - consultare
il listino prezzi per le caratteristiche tecniche, i codici
degli articoli e delle finiture/Dimensions are stated in cm
- for technical characteristics, article code numbers
and finishing see price list;
 - Per la scelta dei contenitori e degli accessori vari,
consultare il relativo listino o catalogo/To choose storage
units and accessories, please check correspondent price
list or catalogue;
- Articoli prodotti solo su richiesta/Items produced only on demand;
- Fino ad esaurimento/Until exhaustion;
- Con serratura/With lock;
- Componenti non collegabili con modulo conversazione /Items that cannot be connected with the conversation counter units.
- Prodotti non in pronta consegna. Per la disponibilità contattare l'ufficio commerciale/Items not in prompt delivery. Please contact the commercial department to check availability;

Abako

DV701

Arredo d'immagine e professionalità. Elementi lineari, linee arrotondate, dettagli ad alta valenza formale e inediti accostamenti di materiali; come un biglietto da visita dell'azienda, i banchi reception sono il primo luogo di contatto con il pubblico e l'esterno.

Furnishing with image and professionalism. Linear elements, rounded lines, details of high formal valence and unusual combinations of materials; just as a business card, the reception is the first point of contact with the public and the outside world.















Moduli bancone in melaminico o laminato / Reception units melamine or laminate finishes

Pannelli verticali sp. 1.8 cm, in melaminico (*) o laminato (**)
Vertical panels 1.8 cm thick, in melamine (*) or laminate (**)



Piani di lavoro sp. 2.5 cm, in melaminico /
Worktops 2.5 cm thick, in melamine



Top sp. 1.2 cm, in vetro temperato /
Top 1.2 cm thick, tempered glass



Gambe in metallo - Supporti top in zama Piedini in ABS /
Metal legs - Die cast zama supports - ABS feet



Note

Per i colori e le finiture dei Frontal Panels, vedere il relativo capitolo in DV300 - Accessori. / For colours and finishes of Frontal Panels, see the chapter in DV300 - Accessories.
 Prodotti non in pronta consegna. Per la disponibilità contattare l'ufficio commerciale. / Items not in prompt delivery. Please contact the commercial department to check availability.

Moduli bancone dritti - Moduli bancone curvi 60° - Moduli bancone raccordo 90° / Straight counter units - 60° curved counter units - 90° counter corner units

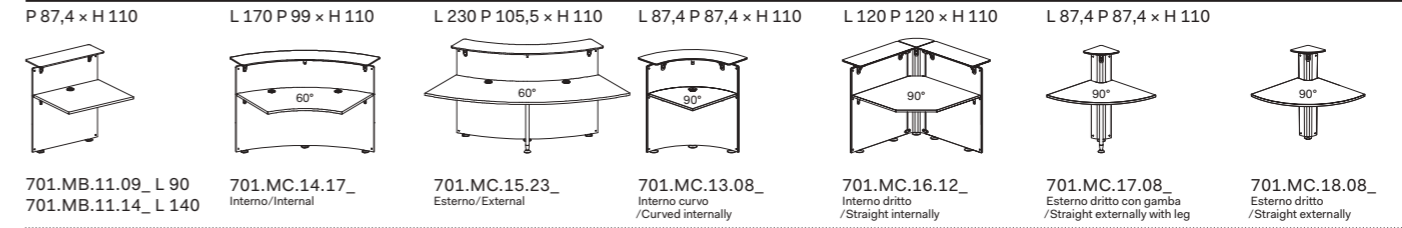

Note: Il top in vetro extrachiaro retrolaccato non è in pronta consegna. Per la disponibilità contattare l'ufficio commerciale / Extra-light rear-lacquered glass top is not in prompt delivery. Please contact the commercial department to check availability

Moduli bancone con piano conversazione - Gambe - Fianchi / Counter units with conversation top - Legs - Sides

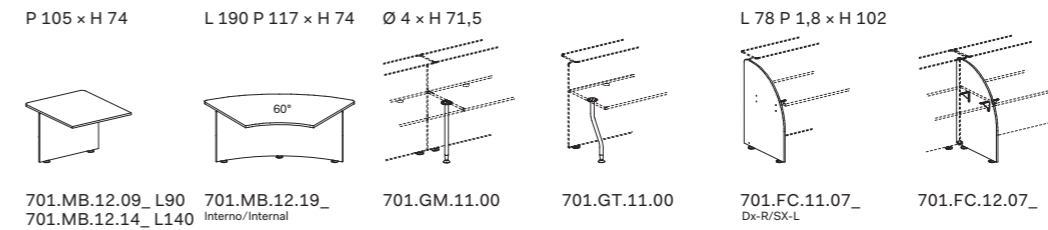

Cassettiere su ruote / Pedestals on castors

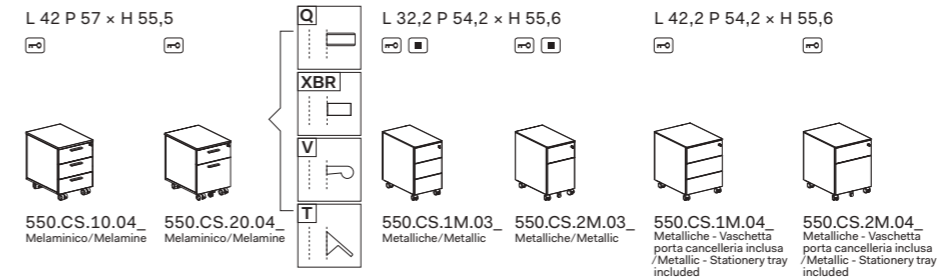

Note: Per portacancelleria cassetti, vedi capitolo DV300-Accessori / For stationary tray, see chapter DV300-Accessories.

Canalizzazione - Elettificazione / Wire-Management - Electrification

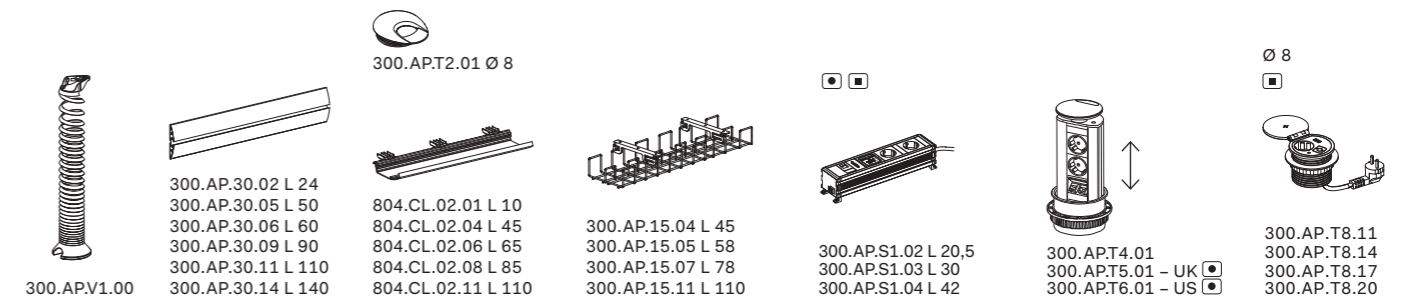

Accessori / Accessories

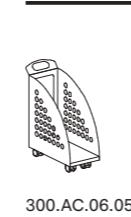

300.AC.06.05

Bracci porta video / Arms for video support

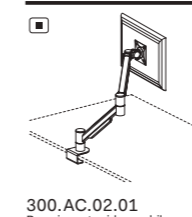

300.AC.02.01
Braccio porta video mobile su piano / Dynamic arm for video support on deskbase

Note:

- Per la scelta dei contenitori e degli accessori vari, consultare il relativo listino o catalogo / To choose storage units and accessories, please check correspondent price list or catalogue;
- Le dimensioni sono espresse in cm - consultare il listino prezzi per le caratteristiche tecniche, i codici degli articoli e delle finiture / Dimensions are stated in cm - for technical characteristics, article code numbers and finishing see price list;
- Progettare la composizione del bancone ed aggiungere: n°1 gamba intermedia, o fianco intermedio per ogni collegamento tra due moduli; n°1 gamba terminale Dx o Sx o fianco terminale Dx o Sx per ogni lato finale del bancone; / When designing the counter composition, add the following elements: n°1 middle leg or middle side for each connection between two counters; n°1 terminal leg (RH or LH) or terminal side (RH or LH) on each side of the counter unit;
- Prodotti non in pronta consegna. Per la disponibilità contattare l'ufficio commerciale / Items not in prompt delivery. Please contact the commercial department to check availability;
- Articoli prodotti solo su richiesta / Items produced only on demand;
- Con serratura / With lock.

Qubo

DV703

Minimalismo e pulizia progettuale. La collezione si presenta come elemento dedicato all'accoglienza. I banconi da reception per ufficio sono caratterizzati da elementi semplici che, accostati tra di loro, definiscono lo spazio di primo contatto.

Minimalism and clean design. The collection is presented as an element dedicated to hospitality. The reception desks for offices are characterized by simple elements which, combined with each other, define the space of first contact.









Il piano conversazione si integra perfettamente con i diversi moduli bancone e consente di creare uno spazio di grande utilità sia per gli operatori che per il pubblico, senza compromettere l'estetica e la funzione della composizione realizzata.

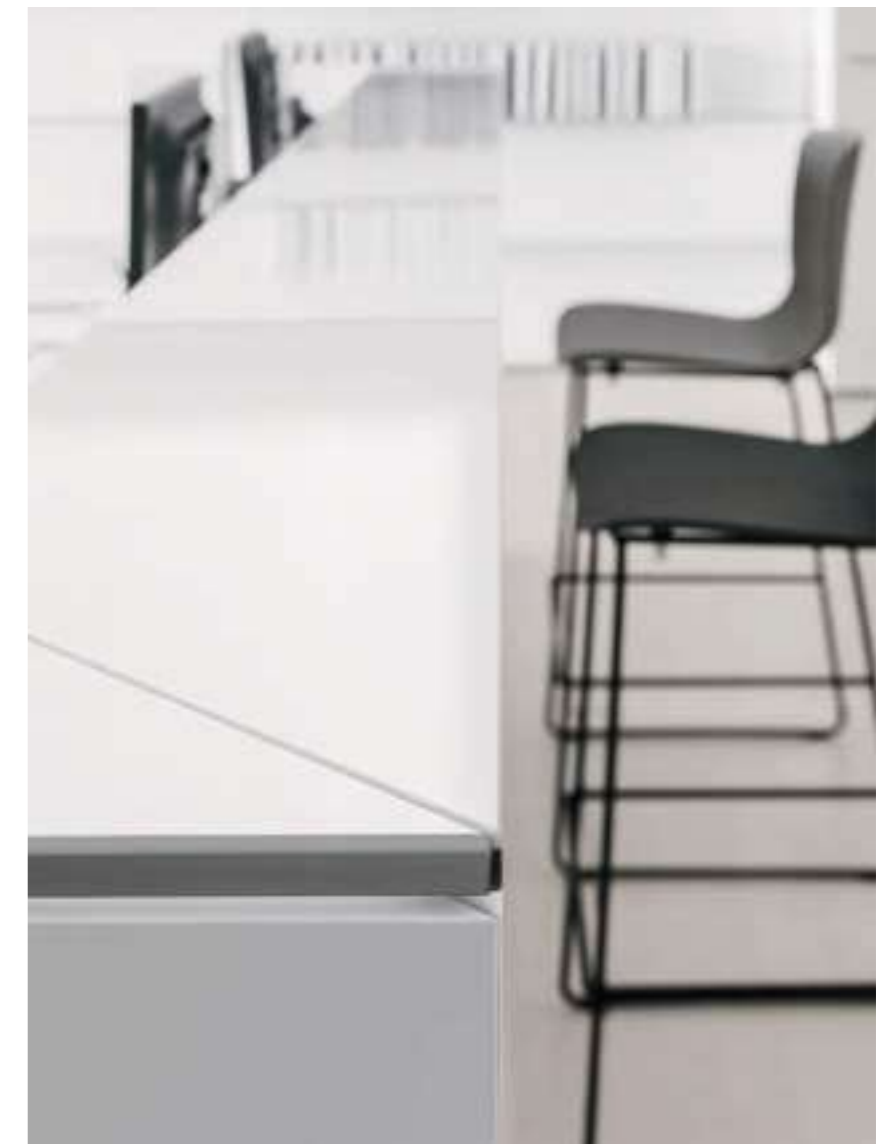

The conversation worktop, seamlessly integrated within the different counter modules, gives a space of great use both to the operator and the public alike, without compromising the aesthetic and function of the counter-desk.



Per arricchire la serie,
è stato integrato un
"top accettazione"
che si abbina in modo
elegante alle diverse
finiture del bancone.

*To enrich the series, a
"decorative top" has
been integrated that
elegantly combines
with the different
finishes of the counter.*







Il disegno ricercato e particolare dei top terminali, caratterizza e rende riconoscibile lo stile di questa reception, anche nelle composizioni più semplici e lineari.

The particular design of the terminal tops provides the character and style of this reception desk, even in the most simple and linear compositions.





Moduli bancone / Counter modules

Pannelli verticali sp. 2.5 cm, in melaminico con bordi in ABS sp. 0.15 cm / Vertical panels 2.5 cm thick, in melamine with ABS edge-profile 0.15 cm thick

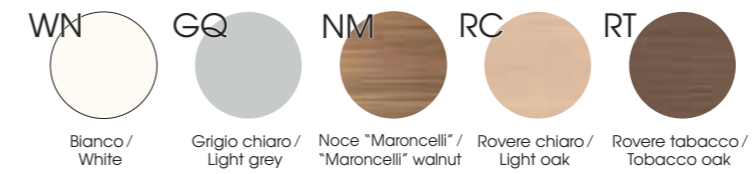

Piani di lavoro sp. 2.5 cm, in melaminico con bordi in ABS sp. 0.2 cm / Worktops 2.5 cm thick, in melamine with ABS edge-profile 0.2 cm thick

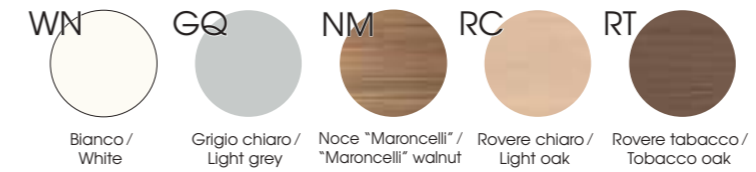

Abbinamento tops / Tops combinations

Top sp. 1.8 cm, in melaminico (*) o laminato (***) con bordi in PMMA bicolore sp. 0.15 cm / Top 1.8 cm thick, melamine (*) or laminate (***) with PMMA edges-profiles 0.15 cm thick

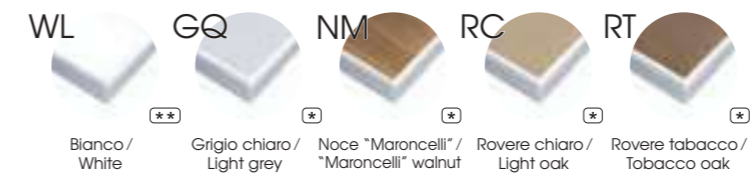

Colonna metallica / Metal column



Zoccoli in alluminio / Aluminium plinth



Supporti in zama / Supports in zamak



Box multiuso / Storage box

Box sp. 1 cm, in melaminico con bordi in ABS colore alluminio sp. 0.1 cm / Box 1 cm thick, in melamine with ABS edges-profiles 0.1 cm thick



Composizione in gres / Gres composition



Top accettazione / Decorative top

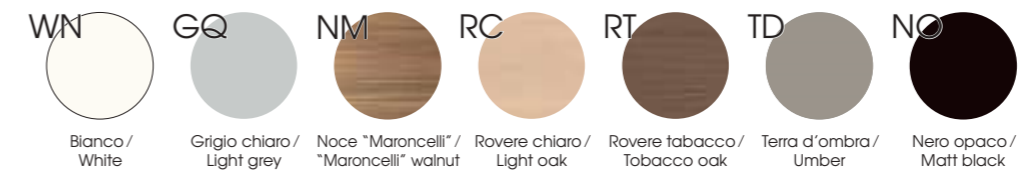

Note

Prodotti non in pronta consegna. Per la disponibilità contattare l'ufficio commerciale / Items not in prompt delivery. Please contact the commercial department to check availability

Moduli bancone standard/Standard counter units

<p>P 84 x H 112,5</p> <p>703.MB.01.08_ L 80 703.MB.01.14_ L 140 703.MB.01.16_ L 160 703.MB.01.20_ L 200</p> <p>Moduli dritti/Straight counter units</p>	<p>L 84 P 84 x H 112,5</p> <p>703.MB.03.08_ Raccordo 90° a 2 vie /2 ways 90° connection unit</p>	<p>L 84 P 84 x H 112,5</p> <p>703.MB.04.08_ Terminale 90° Dx-Sx /Terminal counter unit 90° R - L</p>
---	--	--

Componenti per moduli bancone/Components for counter units

<p>P 2,5 x H 110</p> <p>703.SQ.01.08_ L 80 703.SQ.01.14_ L 140 703.SQ.01.16_ L 160 703.SQ.01.20_ L 200</p> <p>Schieni per moduli dritti /Back panels for straight units</p>	<p>L 84 P 84 x H 110</p> <p>703.SQ.02.08_ Schiene per moduli 90° /Back panels for 90° units</p>	<p>P 80 x H 2,5</p> <p>703.PQ.01.08_ L 80 703.PQ.01.14_ L 140 703.PQ.01.16_ L 160 703.PQ.01.20_ L 200</p> <p>Piani scrivania per moduli dritti /Worktops for straight units</p>	<p>L 80 P 80 x H 2,5</p> <p>703.PQ.02.08_ Piani scrivania per moduli 90° /Worktops for 90° units</p>
---	---	---	--

Componenti per moduli bancone/Components for counter modules

<p>P 30 x H 1,8</p> <p>703.TQ.01.08_ L 80 703.TQ.01.14_ L 140 703.TQ.01.16_ L 160 703.TQ.01.20_ L 200</p> <p>Top per moduli dritti /Top for straight units</p>	<p>L 84 P 84 x H 1,8</p> <p>703.TQ.02.08_ Top per raccordo 90° a 2 vie /Top for 90° units</p>	<p>L 84 P 84 x H 1,8</p> <p>703.TQ.03.08_ Top per terminali 90° Dx - Sx /R - L top for 90° terminal units</p>	<p>L 84 P 2,5 x H 112,5</p> <p>703.FC.01.08_ Sx/L - Dx/R Fianchi terminali Dx - Sx /R - L terminal sides</p>	<p>L 5 P 5 x H 71,5</p> <p>703.GM.01.01 Colonna intermedia /Intermediate slim column</p>	<p>P 2,5 x H 8</p> <p>703.ZB.01.08 L 80 703.ZB.01.14 L 140 703.ZB.01.16 L 160 703.ZB.01.20 L 200</p> <p>Zoccoli per moduli dritti/Metal plinth for straight units (Optional)</p>	<p>L 84 P 84 x H 8</p> <p>703.ZB.02.08 Zoccoli per moduli 90° /Metal plinth for 90° units (Optional)</p>
--	---	---	--	--	--	--

Moduli bancone con piano conversazione/Counter units with conversation top

<p>L 140 P 115 x H 74</p> <p>703.MB.02.14_ Modulo conversazione /Conversation counter unit</p>	<p>L 140 P 2,5 x H 71,5</p> <p>703.SQ.03.14_ Schiena per modulo conversazione /Back panels for conversation unit</p>	<p>L 140 P 115 x H 2,5</p> <p>703.PQ.03.14_ Piano per modulo conversazione /Worktop for conversation unit</p>	<p>L 84 P 2,5 x H 74</p> <p>703.FC.03.08_ Sx/L - Dx/R Fianchi terminali per modulo conversazione /Terminal sides for conversation unit</p>	<p>L 28 P 2,5 x H 39</p> <p>703.CT.A1.02_ Sx/L - Dx/R Fianchetti superiori per modulo conversazione /Small sides for conversation panels</p>
--	--	---	--	--

Top accettazione/Decorative top

<p>P 32,3 x H 74</p> <p>703.TA.01.14_ L 140 703.TA.01.16_ L 160</p>	<p>L 42 P 65 x H 72,2</p> <p>703.LQ.02.14_ L 140 703.LQ.02.16_ L 160</p>
---	--

Cassettiere portanti/Carrying pedestals

<p>L 42 P 65 x H 72,2</p> <p>550.CS.30.04_ Cassettiere senza top per integrazione sotto il piano di lavoro /Pedestals without top to be integrated under the worktop</p>	<p>H 1,8</p> <p>550.CS.40.04_ Zoccolo (Optional) /Base frame (Optional)</p>
--	---

Cassettiere/Pedestals

<p>L 42 P 57 x H 55,5</p> <p>550.CS.10.04_ Melaminico/Melamine 550.CS.20.04_ Melaminico/Melamine</p>	<p>L 32,2 P 54,2 x H 55,6</p> <p>550.CS.1M.03_ Metalliche/Metallic 550.CS.2M.03_ Metalliche/Metallic</p>	<p>L 42,2 P 54,2 x H 55,6</p> <p>550.CS.1M.04_ Metalliche - Vaschetta porta cancelleria inclusa /Metallic - Stationery tray included 550.CS.2M.04_ Metalliche - Vaschetta porta cancelleria inclusa /Metallic - Stationery tray included</p>
--	--	--

[Note:] Per portacancelleria cassetti, vedi capitolo DV300-Accessori / For stationary tray, see chapter DV300-Accessories.

Composizione in gres/Gres composition

L 247 P 84 x H 112,5

703.CM.P1

Bracci porta video/Arms for video support

300.AC.02.01 Braccio porta video mobile su piano /Dynamic arm for video support on deskbase

Accessori/Accessories

L 35 P 24 x H 35

300.AC.14.03

Canalizzazione - Elettificazione/Wire-Management - Electrification

<p>300.AP.V1.00</p>	<p>300.AP.15.05 L 58 For 703.MB.01.08_/703.MB.04.08_ 300.AP.15.08 L 88 For 703.MB.01.20_ 300.AP.15.11 L 110 For 703.MB.01.14_/703.MB.02.14_ 300.AP.15.14 L 140 For 703.MB.01.16_</p>	<p>703.AP.01.04 L 45 For 703.MB.03.08_</p>	<p>300.AP.S1.02 L 20,5 300.AP.S1.03 L 30 300.AP.S1.04 L 42</p>	<p>300.APT4.01 300.APT5.01 - UK 300.APT6.01 - US</p>	<p>300.AP.T8.11 300.AP.T8.14 300.AP.T8.17 300.AP.T8.20</p>
---------------------	--	--	--	--	--

<p>300.AP.T2.01 Ø 8</p>	<p>300.AP.T7.01 Ø 6 300.AP.T8.01 Ø 8</p>	<p>703.LQ.03.00 L 55</p>	<p>703.KQ.03.00 15W/100 - 240V ± 12V</p>
-------------------------	--	--------------------------	--

300.AC.06.05_

Note:

- Progettare la composizione del bancone ed aggiungere: n°1 gamba intermedia per ogni collegamento tra due moduli; n° 1 fianco terminale dx o sx, o fianco terminale conversazione per ogni lato finale del bancone; copertura superiore per ogni collegamento tra modulo conversazione e modulo bancone / When designing the counter composition, add the following elements: n°1 middle leg for each connection between two counters; n°1 terminal side (RH or LH), or terminal side for conversation counter unit on each side of the counter unit; upper cover element for the connection between the conversation counter unit and the standard counter unit;
 - Per la scelta dei contenitori e degli accessori vari, consultare il relativo listino o catalogo/To choose storage units and accessories, please check correspondent price list or catalogue;
 - Le dimensioni sono espresse in cm - consultare il listino prezzi per le caratteristiche tecniche, i codici degli articoli e delle finiture/Dimensions are stated in cm - for technical characteristics, article code numbers and finishing see price list;
- Le schiene L=200 cm non sono disponibili noce "Maroncelli"/The back panels W=200 cm are not available in "Maroncelli" walnut.
- Prodotti non in pronta consegna. Per la disponibilità contattare l'ufficio commerciale/Items not in prompt delivery. Please contact the commercial department to check availability;
- Articoli prodotti solo su richiesta/Items produced only on demand;
- Con serratura/With lock.
- Fino ad esaurimento/Until exhaustion;

Executives

“Le prestigiose collezioni di mobili e scrivanie per lo spazio ufficio direzionale.”
Una vasta gamma di prodotti e soluzioni che si adattano perfettamente ad ogni esigenza: minimalismo, ricerca del dettaglio, preziosità dei materiali, eleganza e originalità.

“Prestigious executive collections for executives space.”
A wide range of products and solutions for any need: minimalist style, detail research, precious materials, elegance and originality.

Vigo P. 62



Noto P. 76



Tokio P. 92



Rym P. 100



Rodi P. 114



Tay P. 120



Vertigo P. 134



Planeta P. 152



Oxford P. 166



Vigo

DV913

È un sistema d'arredo direzionale concepito per conferire decisa e peculiare personalità allo spazio ufficio, un habitat professionale all'insegna della tecnologia e del comfort, nonché flessibile e aperto agli spazi condivisi.

Is an executive furnishing collection designed to give a strong and distinctive personality to the office space, a professional habitat characterized by technology and comfort, flexible and open to common areas.





Il mobile-libreria della collezione dispone di vani a giorno e ante a ribalta e presenta un'elegante soluzione estetica anche per le basi di sostegno.

The bookcase-cabinet of the collection has open compartments and flap doors and presents an elegant aesthetic solution even for the support bases.





Le strutture dei tavoli mettono in evidenza la particolare composizione tra la gamba portante e il telaio in alluminio.

The structures of the tables highlight the particular composition between the supporting leg and the aluminum frame.





Vigo accoglie un piano supplementare rotondo in appoggio, per ospitare temporaneamente collaboratori oppure organizzare riunioni ristrette.

Vigo accommodates an additional round top in support, to temporarily accommodate collaborators or organize small meetings.



Tavoli / Tables

Piani di lavoro sp. 5 cm, in melaminico / Worktops 5 cm thick, in melamine



Noce "Maroncelli" / "Maroncelli" walnut Rovere chiaro / Light oak

Piani superiori in melaminico sp. 1 cm, piani composti lato visitatore / Melamine upper worktops 1 cm thick, compound worktops customer side



Noce "Maroncelli" / "Maroncelli" walnut Rovere chiaro / Light oak

Piani superiori in vetro serigrafato sp. 1 cm, piani composti lato operatore / Glass upper worktops 1 cm thick, compound worktops worker side

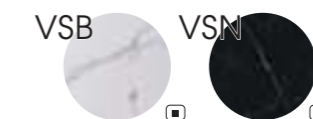

Bianco / White Nero / Black

Gambe in folding sp. 10 cm / Legs in folding 10 cm thick



Noce "Maroncelli" / "Maroncelli" walnut Rovere chiaro / Light oak Nero opaco / Matt black

Modesty panel sp. 3 cm / Modesty panel 3 cm thick



Noce "Maroncelli" / "Maroncelli" walnut Rovere chiaro / Light oak

Cassettiera sp. 1.8 cm per allungo a giorno / Drawer 1.8 cm thick for open extension table



Noce "Maroncelli" / "Maroncelli" walnut Rovere chiaro / Light oak

Libreria / Bookshelf

Scocca libreria sp. 3 o 5 cm / Bookshelf body 3 or 5 cm thick



Noce "Maroncelli" / "Maroncelli" walnut Rovere chiaro / Light oak

Ante a ribalta e schiena libreria sp. 1.8 cm / Bookshelf flap doors and back panel 1.8 cm thick



Noce "Maroncelli" / "Maroncelli" walnut Rovere chiaro / Light oak Nero opaco / Matt black

Strutture metalliche / Metal structures

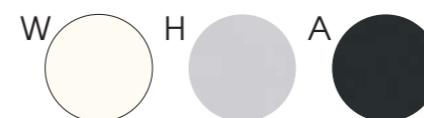

Bianco / White Alluminio / Aluminium Antracite / Anthracite

Note

■ Prodotti non in pronta consegna. Per la disponibilità contattare l'ufficio commerciale / Items not in prompt delivery. Please contact the commercial department to check availability.

Tavoli H. 75 cm con piani di lavoro interi in melaminico sp. 5 / Desk tables H.75 cm with whole worktops in melamine 5 cm thick

<p>P 130 x H 75 <small>PI</small></p> <p>913.TS.61.26_ L 265 Dx/R - Sx/L 913.TS.61.28_ L 285 Dx/R - Sx/L Tavoli scrivania con penisola / Desk tables with peninsula</p>	<p>P 220 x H 75 <small>PI</small></p> <p>913.TM.36.20_ L 200 Dx/R - Sx/L 913.TM.36.22_ L 220 Dx/R - Sx/L Tavoli con allungo a giorno / Tables with open extension</p>	<p>P 220 x H 75 <small>PI</small></p> <p>913.TM.46.23_ L 230 Dx/R - Sx/L 913.TM.46.25_ L 250 Dx/R - Sx/L Tavoli con allungo laterale / Tables with lateral extension</p>
---	---	--

Tavoli H. 76 cm con piani di lavoro sp. 6, composti da piani in melaminico sp. 5 più piani in melaminico o vetro sp. 1 / Desk tables H.76 with 6 cm thick worktops, composed of 5 cm th. melamine worktop plus 1 cm th. melamine or glass top

<p>P 130 - H 76 <small>CM</small></p> <p>913.TS.62.26_ L 265 Dx/R - Sx/L 913.TS.62.28_ L 285 Dx/R - Sx/L Tavoli scrivania con penisola / Desk tables with peninsula</p>	<p>P 220 x H 76 <small>CM</small></p> <p>913.TM.37.20_ L 200 Dx/R - Sx/L 913.TM.37.22_ L 220 Dx/R - Sx/L Tavoli con allungo a giorno / Tables with open extension</p>	<p>P 220 x H 76 <small>CM</small></p> <p>913.TM.47.23_ L 230 Dx/R - Sx/L 913.TM.47.25_ L 250 Dx/R - Sx/L Tavoli con allungo laterale / Tables with lateral extension</p>
---	---	--

Penisola H. 75 cm con piano in melaminico sp. 5 / Peninsula H.75 cm with melamine top 5 cm thick

ø 130 x H 75
PI

913.PE.01.13_ Dx/R - Sx/L

Penisola H. 76 cm con piano sp. 6 cm, composto da piani in melaminico sp. 5 + 1 cm / Peninsula H.76 cm with 6 cm thick top, composed of 5 cm + 1 cm th. melamine tops

ø 130 x H 76
CM

913.PE.02.13_ Dx/R - Sx/L

Tavoli riunione H. 75 cm con piani di lavoro interi in melaminico sp. 5 cm con bordi perimetrali in ABS / Meeting tables H.75 cm with whole worktops in melamine 5 cm thick with perimetrical edges in ABS

<p>P 120 - H 75</p> <p>913.TR.41.24_ L 240</p>	<p>Ø 140 - H 75</p> <p>913.TR.11.14_</p>
--	--

Libreria con ante a ribalta / Bookshelf with flap doors

P 45 - H 158

913.CL.RL.20_ L 215

Note:

1 Le finiture in vetro serigrafato non sono in pronta consegna. Per la disponibilità contattare l'ufficio commerciale / Silkscreen glass finishes are not in prompt delivery. Please contact the commercial department to check availability;

2 Le dimensioni sono espresse in cm - consultare il listino prezzi per le caratteristiche tecniche, i codici degli articoli e delle finiture / Dimensions are stated in cm - for technical characteristics, article code numbers and finishing see price list;

3 Per la scelta dei contenitori e degli accessori vari, consultare il relativo listino o catalogo / To choose storage units and accessories, please check correspondent price list or catalogue;

4 Prodotti non in pronta consegna. Per la disponibilità contattare l'ufficio commerciale / Items not in prompt delivery. Please contact the commercial department to check availability;

5 Ai tavoli con allungo a giorno è possibile integrare la cassetteria 913.MC.02.06_ / It is possible to integrate 913.MC.02.06_ pedestals in the tables with open extension.

PI Piano intero / Full worktop.
CM Piano composto / Compound worktop.

Cassettiera con 1 cassetto per tavolo con allungo a giorno / Drawer with one drawer for tables with open lateral extension

L 60 P 50 x H 36,5
PI

913.MC.02.06_

Accessori per cassetteria cod. 913.MC.02.06 / Accessories for drawer cod. 913.MC.02.06

<p>L 56 P 41 x H 11 <small>CM</small></p> <p>913.CS.01.05 Cassetto Optional interno / Optional internal drawer</p>	<p>L 55 P 40 x H 8</p> <p>913.CA.S6.08 Reggicartella per cassetto / Frame for folders for drawers</p>	<p>L 33 L 39</p> <p>503.CS.P1.00 L 33 503.CS.P2.00 L 39</p>
--	---	---

Note: Per l'integrazione degli accessori con la cassetteria consultare il manuale tecnico / For integration of accessories with the drawers please check technical manual

Cassettiere su ruote / Pedestals on castors

<p>L 42 P 57 x H 55,5 <small>CM</small></p> <p>550.CS.10.04_ Melaminico / Melamine</p>	<p>L 42,2 P 54,2 x H 55,6 <small>CM</small></p> <p>550.CS.20.04_ Melaminico / Melamine</p>	<p>L 32,2 P 54,2 x H 55,6 <small>CM</small></p> <p>550.CS.1M.03_ Metalliche / Metallic</p>	<p>L 32,2 P 54,2 x H 55,6 <small>CM</small></p> <p>550.CS.2M.03_ Metalliche / Metallic</p>	<p>L 42,2 P 54,2 x H 55,6 <small>CM</small></p> <p>550.CS.1M.04_ Metalliche - Vaschetta porta cancelleria inclusa / Metallic - Stationery tray included</p>	<p>L 42,2 P 54,2 x H 55,6 <small>CM</small></p> <p>550.CS.2M.04_ Metalliche - Vaschetta porta cancelleria inclusa / Metallic - Stationery tray included</p>
--	--	--	--	---	---

Note: Per portacancelleria cassetti, vedi capitolo DV300-Accessori / For stationary tray, see chapter DV300-Accessories.

Accessori per Elettrificazione - Vari / Accessories for Electrification - Various

L 90 P 60 x H 2

300.AP.S1.02 L 20,5
300.AP.S1.03 L 30
300.AP.S1.04 L 42

300.AS.01.09

Note:

1 Le finiture in vetro serigrafato non sono in pronta consegna. Per la disponibilità contattare l'ufficio commerciale / Silkscreen glass finishes are not in prompt delivery. Please contact the commercial department to check availability;

2 Le dimensioni sono espresse in cm - consultare il listino prezzi per le caratteristiche tecniche, i codici degli articoli e delle finiture / Dimensions are stated in cm - for technical characteristics, article code numbers and finishing see price list;

3 Per la scelta dei contenitori e degli accessori vari, consultare il relativo listino o catalogo / To choose storage units and accessories, please check correspondent price list or catalogue;

4 Prodotti non in pronta consegna. Per la disponibilità contattare l'ufficio commerciale / Items not in prompt delivery. Please contact the commercial department to check availability;

5 Articoli prodotti solo su richiesta / Items produced only on demand;

6 Con serratura / With lock.

7 Ai tavoli con allungo a giorno è possibile integrare la cassetteria 913.MC.02.06_ / It is possible to integrate 913.MC.02.06_ pedestals in the tables with open extension.

Noto

DV911

La collezione riprende l'idea del classico tavolo da lavoro su cavalletto. La struttura è in legno massello e il piano, disponibile nelle versioni rettangolare e rotonda, è proposto in tre diverse finiture che conferiscono ad ogni tavolo un carattere particolare.

The collection of tables recalls the idea of the classic work table on trestle legs. The structure is in solid wood and the top, available in the rectangular and round versions, is available in three different finishes that give each table a particular character.





Il piano in gres
porcellanato per un
ambiente importante e
raffinato.



*The porcelain
stoneware top
for an important
and refined
environment.*







Tavoli / Tables

Piani di lavoro in vetro sp. 1.2 cm, con bordi perimetrali lavorati a filo lucido / Glass worktop 1.2 cm thick, with outer polished edges

Piano di lavoro in vetro temprato trasparente sp. 0.8 cm, accoppiato con piano in gres porcellanato sp. 0.6 cm / Worktop in 0.8 cm thick transparent tempered glass, coupled with a 0.6 cm thick porcelain stoneware worktop



Piani di lavoro sp. 2.7 cm, in cuoio con cuciture / Worktop 2.7 cm thick, in leather with stitches



Gambe in legno / Wooden legs



Travi in legno per piani in vetro / Wooden legs for glass worktops



Travi metalliche per piani ciechi e canalizzazione / Metallic beams for non-transparent worktops and canalization



Modesty panel / Modesty panel

Modesty panel in melaminico sp. 2.5 cm / Melamine modesty panel 2.5 cm thick

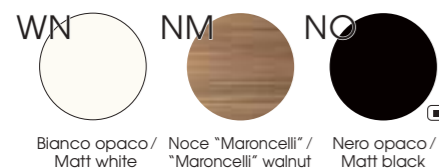

Modesty panel sp. 2.7 cm, in cuoio con cuciture / Modesty panel 2.7 cm thick, in leather with stitches



Note

■ Prodotti non in pronta consegna. Per la disponibilità contattare l'ufficio commerciale / Items not in prompt delivery. Please contact the commercial department to check availability;

Tavoli scrivania con piani in vetro / Desk tables with glass work-top

L 200 P 100 x H 73,5
V □

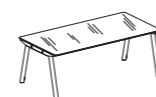

911.TV.04.20_

L 200 P 60 x H 73,5
V □



911.TV.01.20_

L 180 P 90 x H 73,5
V □



911.TV.03.18_

Tavoli scrivania con piani in gres porcellanato / Desk tables with porcelain stoneware work-top

L 200 P 100 x H 73,9
G ● □



911.TV.04.20_

L 200 P 60 x H 73,9
G ● □



911.TV.01.20_

L 180 P 90 x H 73,9
G ● □



911.TV.03.18_

Tavoli con piani in cuoio / Desk tables with leather work-top

L 200 P 100 x H 75,2
C ● □



911.TS.04.20_

L 200 P 60 x H 75,2
C ● □



911.TS.44.20_

L 180 P 90 x H 75,2
C ● □



911.TS.03.18_

Tavoli scrivania/riunione / Meeting-desk tables

L 240 P 120 x H 73,5
V □



911.TV.06.24_

L 178 P 149 x H 73,5
V □



911.TV.28.18_

Ø 140 x H 73,5
V □



911.TV.28.14_

L 240 P 120 x H 73,9
G ● □



911.TV.06.24_

L 178 P 149 x H 73,9
G ● □



911.TV.28.18_

Ø 140 x H 73,9
G ● □



911.TV.28.14_

L 240 - P 120 - H 75,2
C ● □



911.TR.41.24_

L 178 - P 149 - H 75,2
C ● □



911.TR.21.18_

Ø 140 - H 75,2
C ● □



911.TR.21.14_

Note:

1 Le finiture gres e cuoio non sono in pronta consegna. Per la disponibilità contattare l'ufficio commerciale / Porcelain stoneware and leather finishes are not in prompt delivery. Please contact the commercial department to check availability;

2 Per la scelta dei contenitori e degli accessori vari, consultare il relativo listino o catalogo / To choose storage units and accessories, please check correspondent price list or catalogue;

3 Le dimensioni sono espresse in cm - consultare il listino prezzi per le caratteristiche tecniche, i codici degli articoli e delle finiture / Dimensions are stated in cm - for technical characteristics, article code numbers and finishing see price list;

■ Prodotti non in pronta consegna. Per la disponibilità contattare l'ufficio commerciale / Items not in prompt delivery. Please contact the commercial department to check availability;

□ Con gambe in legno e travi in legno / Wood legs and beams

● Con gambe in legno e travi in metallo / Wood legs and metal beams

G Gres/Gres

V Vetro/Glass

C Cuoio/Leather

Tavoli scrivania per integrazione su barra (DV504)/Desk tables for integration on bar (DV504)

L 200 P 100 x H 73,5 V C	L 200 P 60 x H 73,5 V C	L 180 P 90 x H 73,5 V C	L 200 P 100 x H 73,9 G C M	L 200 P 60 x H 73,9 G C M	L 180 P 90 x H 73,9 G C M
911.TV.32.20_	911.TV.30.20_	911.TV.31.18_	911.TV.32.20_	911.TV.30.20_	911.TV.31.18_
L 200 P 100 x H 75,2 C G M	L 200 P 60 x H 75,2 C G M	L 180 P 90 x H 75,2 C G M			
911.TI.22.20_	911.TI.20.20_	911.TI.21.18_			

Tavoli per integrazione su moduli base (DV504)/Desks for integration on modules (DV504 series)

L 200 P 100 x H 73,5 V C	L 200 P 60 x H 73,5 V C	L 180 P 90 x H 73,5 V C	L 200 P 100 x H 73,9 G C M	L 200 P 60 x H 73,9 G C M	L 180 P 90 x H 73,9 G C M
911.TV.09.20_	911.TV.29.20_	911.TV.11.18_	911.TV.09.20_	911.TV.29.20_	911.TV.11.18_
L 200 P 100 x H 75,2 C G M	L 200 P 60 x H 75,2 C G M	L 180 P 90 x H 75,2 C G M			
911.TI.13.20_	911.TI.01.20_	911.TI.15.18_			

Cassettiere su ruote/Pedestals on castors

L 42 P 57 x H 55,5 C	L 32,2 P 54,2 x H 55,6 C	L 42,2 P 54,2 x H 55,6 C
550.CS.10.04_ Melaminico /Melamine	550.CS.1M.03_ Metalliche /Metallic	550.CS.1M.04_ Metalliche - Vaschetta porta cancelleria inclusa /Metallic - Stationery tray included
550.CS.20.04_ Melaminico /Melamine	550.CS.2M.03_ Metalliche /Metallic	550.CS.2M.04_ Metalliche - Vaschetta porta cancelleria inclusa /Metallic - Stationery tray included

Note: Per portacancelleria cassetti, vedi capitolo DV300-Accessori/For stationary tray, see chapter DV300-Accessories.

Modesty panel

P 1,8 x H 32



911.MP.03.08_ L 76
911.MP.01.18_ L 127
911.MP.01.20_ L 147

Modesty panel in cuoio/Leather modesty panel

P 2 x H 32

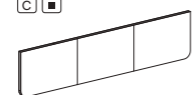

911.MP.03.08_ L 76
911.MP.01.18_ L 127
911.MP.01.20_ L 147

Note:

1 Le finiture gres e cuoio non sono in pronta consegna. Per la disponibilità contattare l'ufficio commerciale /Porcelain stoneware and leather finishes are not in prompt delivery. Please contact the commercial department to check availability;

2 Per la scelta dei contenitori e degli accessori vari, consultare il relativo listino o catalogo/To choose storage units and accessories, please check correspondent price list or catalogue;

3 Le dimensioni sono espresse in cm - consultare il listino prezzi per le caratteristiche tecniche, i codici degli articoli e delle finiture/Dimensions are stated in cm - for technical characteristics, article code numbers and finishing see price list;

4 Prodotti non in pronta consegna. Per la disponibilità contattare l'ufficio commerciale/Items not in prompt delivery. Please contact the commercial department to check availability;

C Con gambe in legno e travi in legno /Wood legs and beams

G Con gambe in legno e travi in metallo /Wood legs and metal beams

V Vetra/Glass

C Cuoio/Leather

M Con serratura/With lock

L Con serratura/With lock

Accessori per canalizzazione - Elettrificazione - Vari/Accessories for wire management - Electrification - Various

300.AC.26.02 L 24,5 300.AC.26.03 L 34,5 300.AC.26.04 L 44,5	300.AC.20.02_ L 24,5 300.AC.20.03_ L 34,5 300.AC.20.04_ L 44,5	300.AC.25.02 L 23,5 300.AC.25.03 L 33,5 300.AC.25.04 L 43,5 Marsupio/Basket	300.AP.S1.02 L 20,5 300.AP.S1.03 L 30 300.AP.S1.04 L 42 Per/For top access 300.AC.26_	300.AT.A6.02 L 21 300.AT.A6.03 L 25,5 300.AT.A6.04 L 39	300.AP.T4.01 300.AP.T5.01 - UK 300.AP.T6.01 - US	300.AP.T8.11 300.AP.T8.14 300.AP.T8.17 300.AP.T8.20
L 32 x P 12,3						
	300.AC.38.03_ H 3	300.AC.67.03 Marsupio per top access 300.AC.38.03 / Basket for top access 300.AC.38.03	300.AP.V1.00	911.AP.08.06_ Canalina verticale per gamba /Vertical cable channel for leg	300.AP.F1.00	300.AP.T7.01 Ø 6 300.AP.T8.01 Ø 8
P 17 - H 9						
	911.AP.01.20_ L 146 Per tavoli P. 60 cm /For desks P.60	911.AP.41.20_ L 180 Carter canaline singole per piani in vetro/Covering carter for glass worktops	911.AP.02.18_ L 126 911.AP.02.20_ L 146 Per tavoli P. 90-100-120 cm /For desks P. 90-100-120 cm	911.AP.03.07_ L 71 Per tavoli tondi /For round tables	911.AP.45.08 L 84 911.AP.43.18 L 160 911.AP.43.20 L 180 Carter canaline doppie per piani in vetro/Carter for double cable channels for glass worktops	911.AP.42.20_ L 182 Carter canaline singole per piani in vetro su barra/Carter for single cable channels for glass worktops on bar
P 24 - H 10						
	911.AP.44.18 L 162 Carter canaline doppie per piani in vetro su barra/Carter for double cable channels for glass worktops on bar	911.AP.44.20 L 182 Carter canaline doppie per piani in vetro su barra/Carter for double cable channels for glass worktops on bar	911.AP.44.18 L 162 Carter canaline doppie per piani in vetro su barra/Carter for double cable channels for glass worktops on bar	911.AP.44.20 L 182 Carter canaline doppie per piani in vetro su barra/Carter for double cable channels for glass worktops on bar	911.AP.44.18 L 162 Carter canaline doppie per piani in vetro su barra/Carter for double cable channels for glass worktops on bar	911.AP.44.20 L 182 Carter canaline doppie per piani in vetro su barra/Carter for double cable channels for glass worktops on bar
L 90 P 60 x H 2						
300.AS.01.09_	300.AC.06.05_					

Bracci porta video/Arms for video support

300.AC.02.01 Braccio porta video mobile su piano /Dynamic arm for video support on deskbase	300.AC.02.02 Doppio braccio porta video mobile su piano/2 dynamic arms for video support on deskbase	300.AC.01.01 Braccio porta video statico su palo /Static arm for video support on pole	300.AC.01.02 Doppio braccio porta video statico su palo/2 Static arms for video support on pole

Note:

1 Le finiture gres e cuoio non sono in pronta consegna. Per la disponibilità contattare l'ufficio commerciale /Porcelain stoneware and leather finishes are not in prompt delivery. Please contact the commercial department to check availability;

2 Per la scelta dei contenitori e degli accessori vari, consultare il relativo listino o catalogo/To choose storage units and accessories, please check correspondent price list or catalogue;

3 Le dimensioni sono espresse in cm - consultare il listino prezzi per le caratteristiche tecniche, i codici degli articoli e delle finiture/Dimensions are stated in cm - for technical characteristics, article code numbers and finishing see price list;

4 Prodotti non in pronta consegna. Per la disponibilità contattare l'ufficio commerciale/Items not in prompt delivery. Please contact the commercial department to check availability;

5 Articoli prodotti solo su richiesta/Items produced only on demand;

6 Fino ad esaurimento/Until exhaustion;

C Cuoio/Leather

Tokio

DV909

Una collezione di tavoli direzionali il cui segno stilistico si distingue per la purezza delle linee e dove ogni singolo dettaglio è studiato per esaltare la struttura architettonica di un tavolo dal forte impatto estetico.

The collection of executive tables is the purity of lines, where every single detail is designed to enhance the architectural structure of a table with a strong aesthetic impact.







Tavoli / Tables

Piani di lavoro sp. 3.7 cm, in folding con laminato FENIX /
Folding worktops 3.7 cm thick, in FENIX laminate



Piani di lavoro sp. 4.2 cm, in listellare placcato laminato FENIX con bordi in ABS sp. 0.1 cm /
Worktop 4.2 cm thick in FENIX laminate with 0.1 cm ABS edge-profiles



Strutture metalliche / Metal structures



Tavoli riunione / Meeting tables

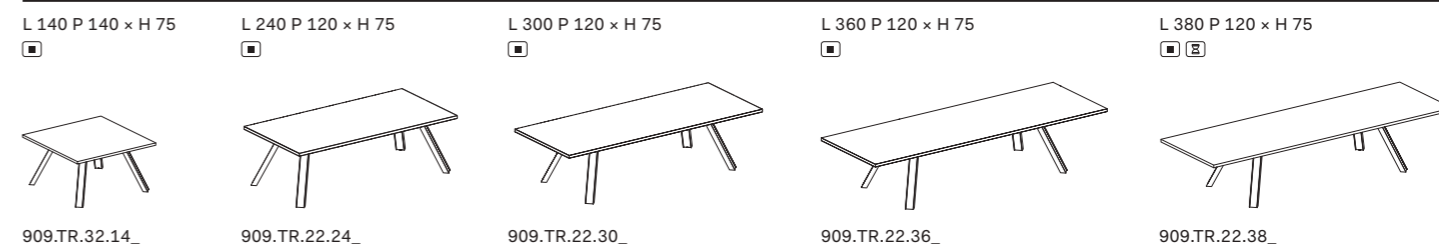

Accessori per canalizzazione - Elettificazione / Accessories for wire management - Electrification

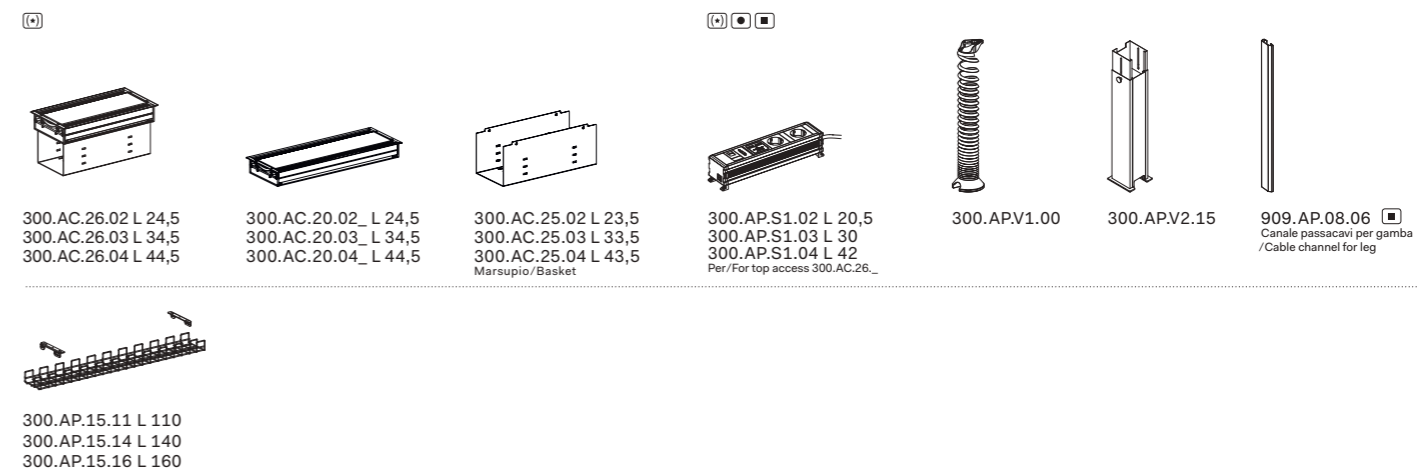

Note

Prodotti non in pronta consegna. Per la disponibilità contattare l'ufficio commerciale / Items not in prompt delivery. Please contact the commercial department to check availability;

Note:

1 Per la scelta dei contenitori e degli accessori vari, consultare il relativo listino o catalogo / To choose storage units and accessories, please check correspondent price list or catalogue;

2 Le dimensioni sono espresse in cm - consultare il listino prezzi per le caratteristiche tecniche, i codici degli articoli e delle finiture / Dimensions are stated in cm - for technical characteristics, article code numbers and finishing see price list;

Prodotti non in pronta consegna. Per la disponibilità contattare l'ufficio commerciale / Items not in prompt delivery. Please contact the commercial department to check availability;

Articoli prodotti solo su richiesta / Items produced only on demand.

Fino ad esaurimento / Until exhaustion;

Rym

DV905

Prestigiosa collezione di scrivanie direzionali per ufficio, dove la ricerca progettuale trova massima espressione. Ampie superfici, stile minimal, ricerca del dettaglio esprimono l'anima di questa collezione.

Prestigious executive collection, where the research of design finds its highest expression. Large surfaces, minimalistic style and detail research express the soul of this collection.





Tra i diversi dettagli presenti nella collezione emerge in modo caratterizzante l'unione ad angolo delle gambe con i profili del piano di lavoro.



Among the different details present in the collection emerges in a way characterizing the corner union of the legs with the profiles of the worktop.







Tavoli / Tables

Piani di lavoro sp. 5 cm, in laminatino /
Worktops 5 cm thick, in low pressure laminate



Piani di lavoro sp. 5 cm, in laminatino Fenix /
Worktops 5 cm thick, in low pressure Fenix laminate



Piani di lavoro sp. 5 cm, in cuoio con cuciture /
Worktop 5 cm thick, in leather with stitches



Piani di lavoro sp. 0.5 cm, in vetro retrolaccato /
Worktops 0.5 cm thick, rear-lacquered glass



Piani di lavoro sp. 0.5 cm, in vetro temprato retrolaccato acidato con bordi perimetrali lavorati a filo lucido /
Worktops 0.5 cm thick, rear-lacquered and acetated tempered glass with outer polished edges



Strutture metalliche / Metal structures

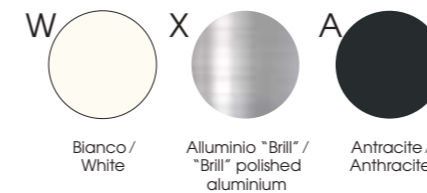

Mobili di servizio / Service units

Scocca, ripiani sp. 2.5 cm e ante sp. 1.8 cm, in melaminico (*) o laminato (**)
Body, shelves 2.5 cm and doors 1.8 cm thick, in melamine (*) or laminate (**)



Note

■ Prodotti non in pronta consegna. Per la disponibilità contattare l'ufficio commerciale / Items not in prompt delivery. Please contact the commercial department to check availability.

Tavoli scrivania/Desks

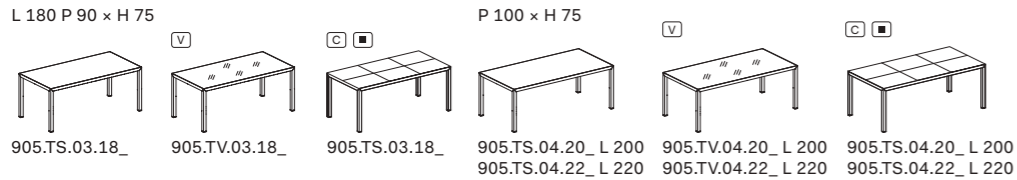

Tavoli e allunghi dattilo / Typing and extension tables

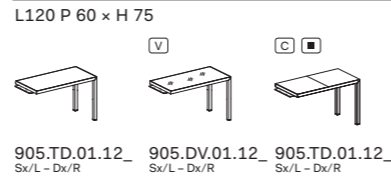

Tavoli per integrazione con mobili di servizio / Desk for integration with service units

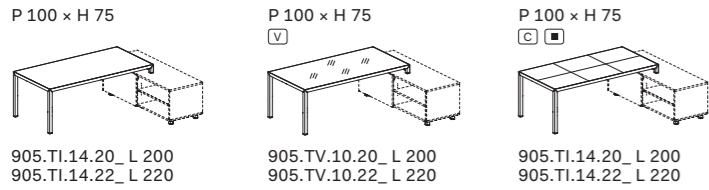

Mobili di servizio e cassetiera interna / Service units and internal pedestal

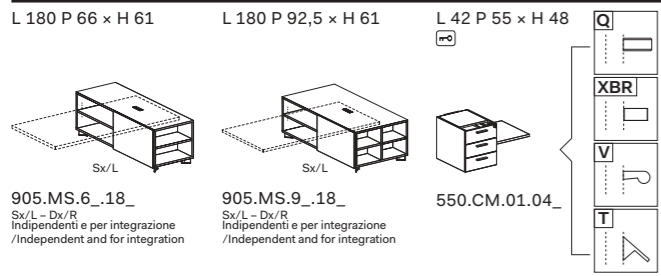

Modesty panels

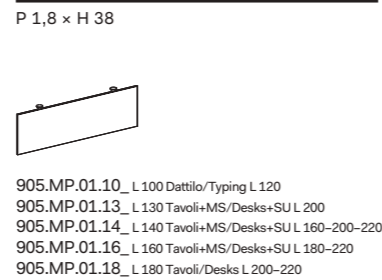

Modesty Panel in cuoio / Leather Modesty Panel

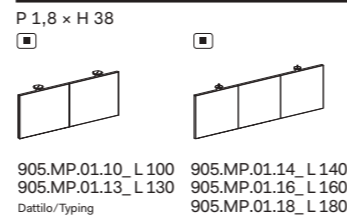

Note: La finitura nero opaco non è in pronta consegna, per la disponibilità contattare l'ufficio commerciale. /Matt black finishes is not in prompt delivery. Please contact the commercial department to check availability.

Tavoli scrivania L 200 x P 100 con mobile di servizio L 180 x P 66/Desks W 200 x D 100 with service unit W 180 x D 66

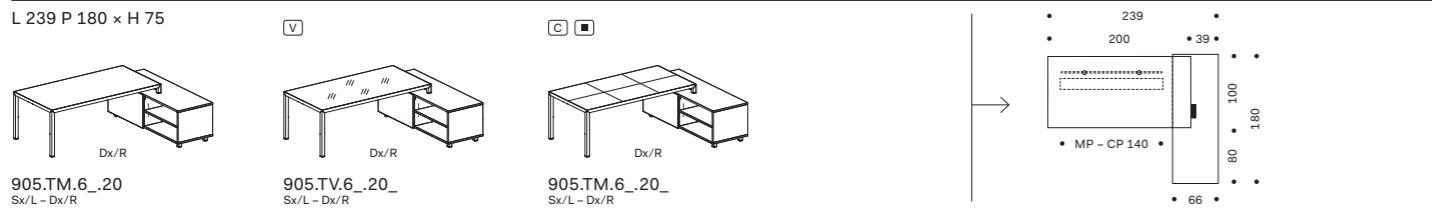

Tavoli scrivania L 220 x P 100 con mobile di servizio L 180 x P 66/Desks W 220 x D 100 with service unit W 180 x D 66

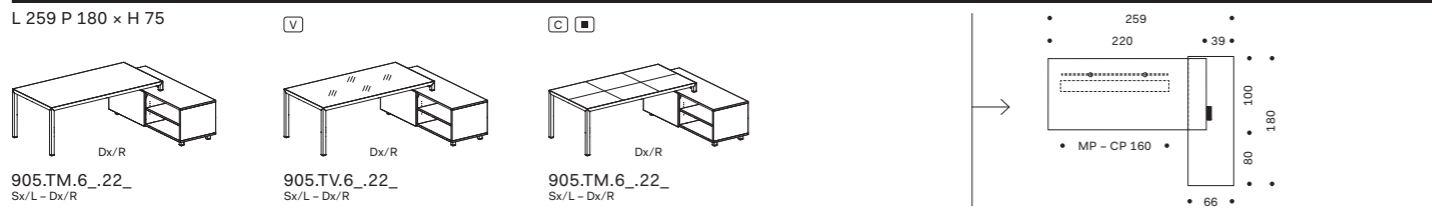

Tavoli scrivania L 200 x P 100 con mobile di servizio L 180 x P 92,5/Desks W 200 x D 100 with service unit W 180 x D 92,5

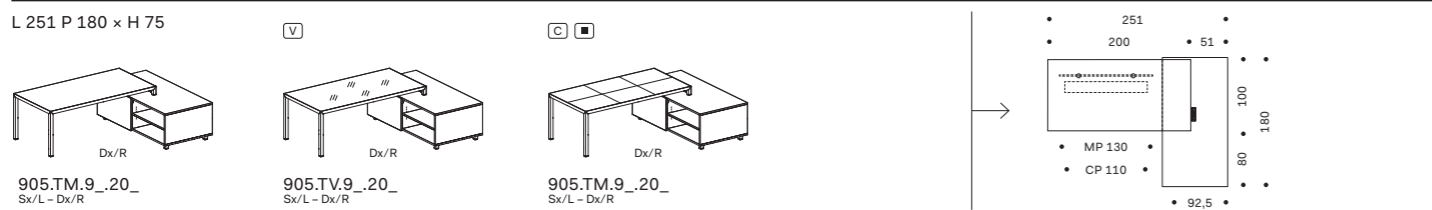

Note: 1 La finitura nero opaco e le finiture in cuoio non sono in pronta consegna. Per la disponibilità contattare l'ufficio commerciale; /Matt black finish and leather finishes are not in prompt delivery. Please contact the commercial department to check availability; 2 Per la scelta dei contenitori e degli accessori vari, consultare il relativo listino o catalogo; /To choose storage units and accessories, please check correspondent price list or catalogue; 3 I tavoli possono essere montati sui mobili di servizio P 66 e P 92,5 cm (destri o sinistri). Per ogni soluzione compositiva è disponibile a listino la dimensione del corrispondente modesty panel (vedi relativa quota indicata con MP) e del corrispondente canale passacavi (vedi relativa quota indicata con CP)/The desks can be fixed on the service units depth 66 and depth 92,5 cm (right or left hand). To order the modesty panel please check the dimensions marked with MP and the dimensions marked with CP for the relevant cables channel;

Tavoli scrivania L 220 x P 100 con mobile di servizio L 180 x P 92,5/Desks W 220 x D 100 with service unit W 180 x D 92,5

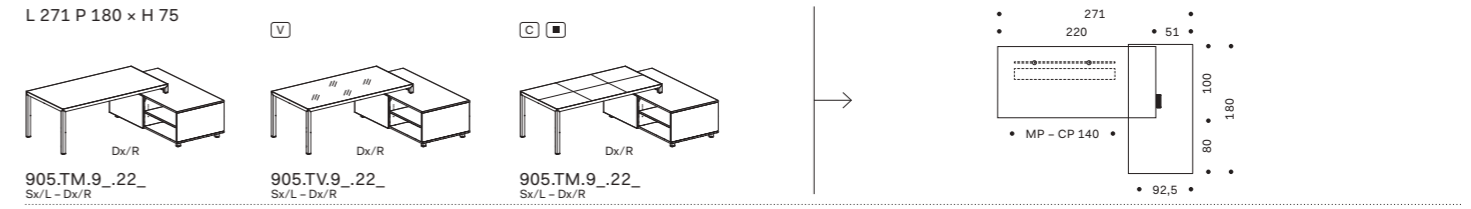

Tavoli scrivania L 160 x P 160 con mobile di servizio L 180 x P 66/Desks W 160 x D 160 with service unit W 180 x D 66

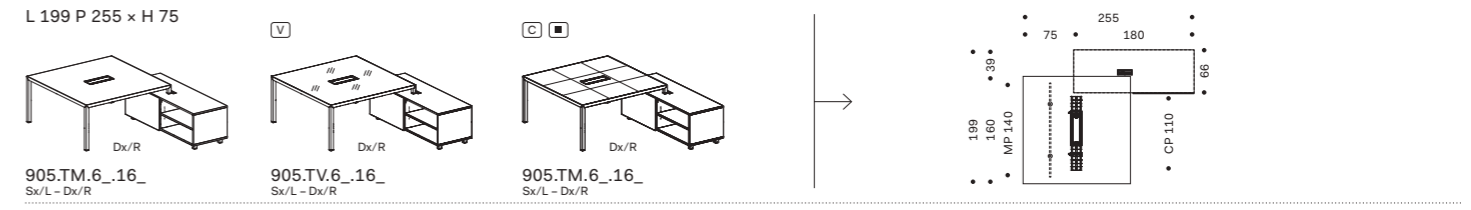

Tavoli scrivania L 160 x P 160 con mobile di servizio L 180 x P 92,5 / Desks W 160 x D 160 with service unit W 180 x D 92,5

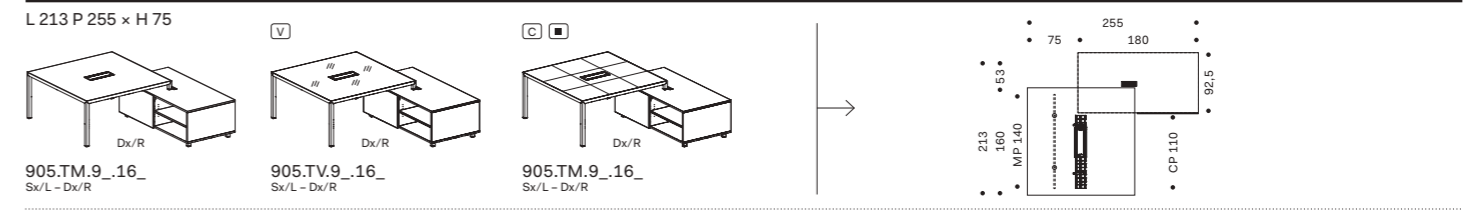

Tavoli riunione/Meeting tables

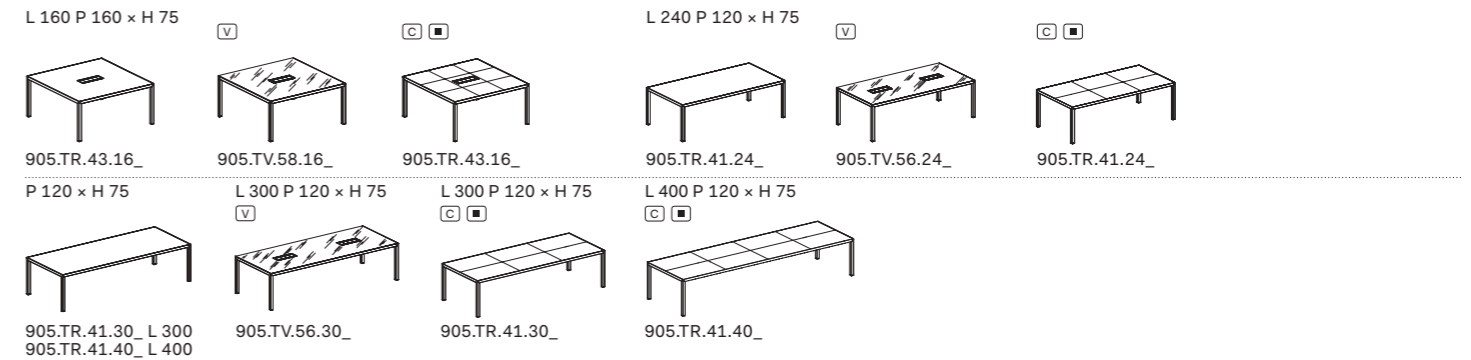

Cassettiere su ruote/Pedestals on castors

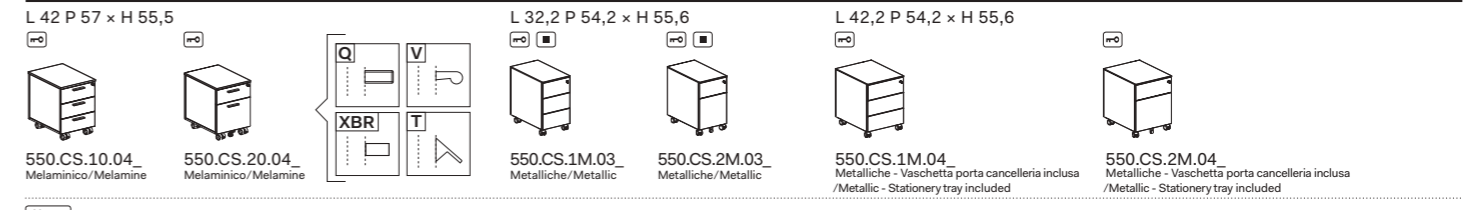

Note: Per portacancelleria cassetti, vedi capitolo DV300-Accessori/For stationary tray, see chapter DV300-Accessories.

Accessori per canalizzazione - Elettrificazione - Vari/Accessories for wire management - Electrification - Various

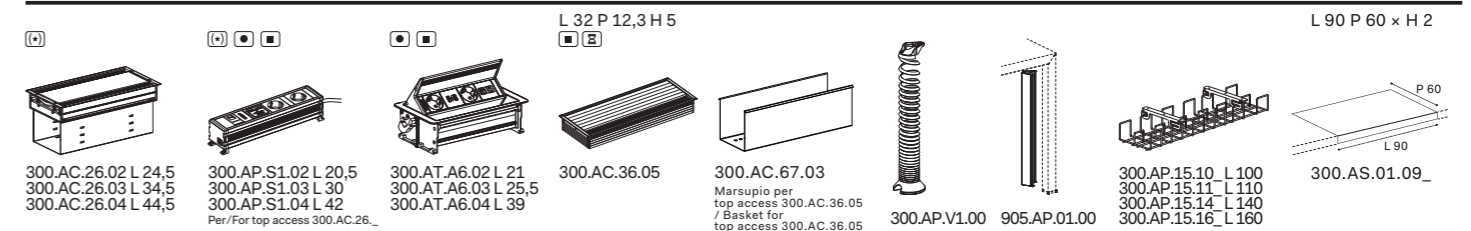

Note: 4 Le dimensioni sono espresse in cm - consultare il listino prezzi per le caratteristiche tecniche, i codici degli articoli e delle finiture/Dimensions are stated in cm - for technical characteristics, article code numbers and finishing see price list; 5 Articoli prodotti solo su richiesta/Items produced; only on demand; 6 Prodotti non in pronta consegna. Per la disponibilità contattare l'ufficio commerciale/Items not in prompt delivery. Please contact the commercial department to check availability; 7 Fino ad esaurimento/Until exhaustion. 8 Con serratura/With lock; 9 Vetro/Glass; 10 Cuoio/Leather.

Rodi

DV908

Geometrie in equilibrio. Tavoli con gambe e piani in "metallo verniciato", sono disponibili in cinque diverse finiture e si adattano ai molteplici ambienti di lavoro.

Balanced geometries. Desks, with legs and worktops in "painted metal", are available in five different finishes and are adaptable to multiple work environments.





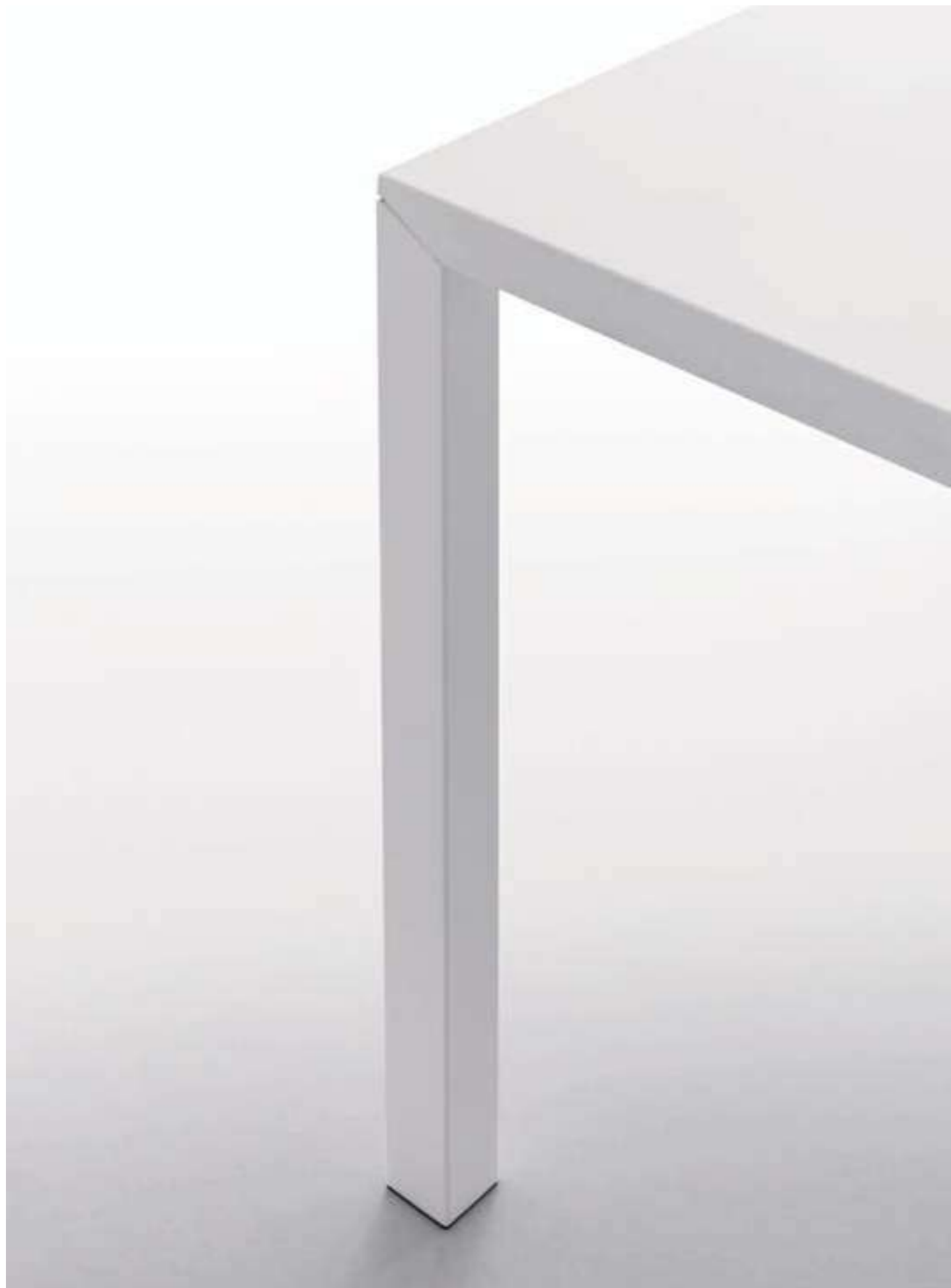

Tavoli / Tables

Piani di lavoro in metallo verniciato, sp. 4 cm / Metal painted worktops, 4 cm thick

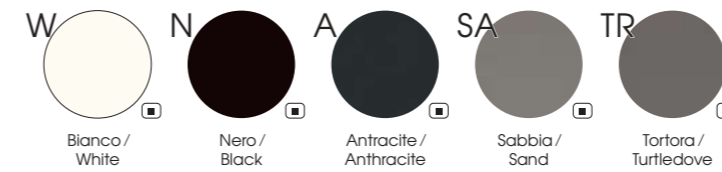

Strutture metalliche / Metal structures

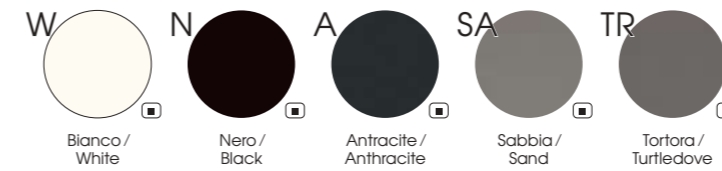

Note

■ Prodotti non in pronta consegna. Per la disponibilità contattare l'ufficio commerciale / Items not in prompt delivery. Please contact the commercial department to check availability.

Dati tecnici / Technical data

Tavoli riunione / Meeting tables

L 200 P 100 x H 75

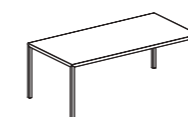

908.TR.42.20_

L 240 P 120 x H 75

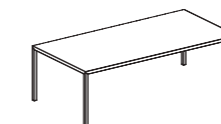

908.TR.41.24_

Accessori per canalizzazione - Elettrificazione / Accessories for wire management - Electrification

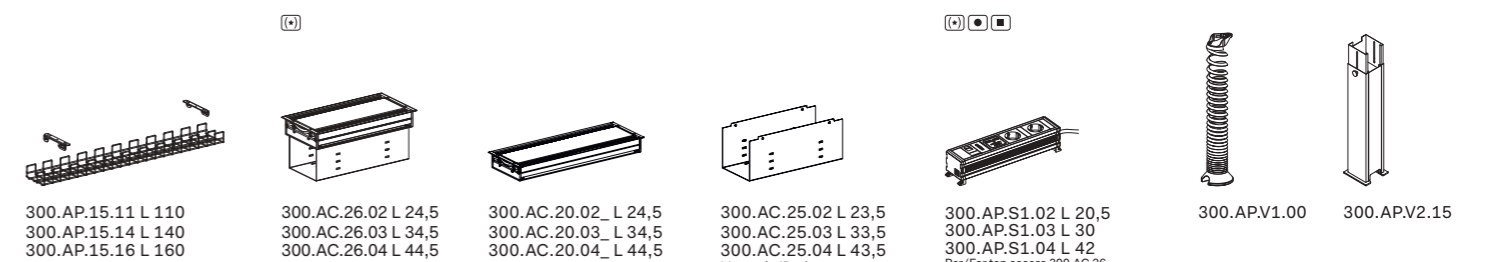

Note:

① Per la scelta dei contenitori e degli accessori vari, consultare il relativo listino o catalogo / To choose storage units and accessories, please check correspondent price list or catalogue;

② Le dimensioni sono espresse in cm - consultare il listino prezzi per le caratteristiche tecniche, i codici degli articoli e delle finiture / Dimensions are stated in cm - for technical characteristics, article code numbers and finishing see price list;

■ Prodotti non in pronta consegna. Per la disponibilità contattare l'ufficio commerciale / Items not in prompt delivery. Please contact the commercial department to check availability;

■ Articoli prodotti solo su richiesta / Items produced only on demand.

Tay DV903

Una collezione di scrivanie per ufficio direzionali di grande impatto estetico, dove la ricchezza dei piani di lavoro e la preziosità delle finiture generano una perfetta sintesi tra funzione e design, tra eleganza e tecnologia.

A collection of great aesthetic impact, where the luxury of the worktops and the preciousness of the finishes create perfect balance between functionality and design, between elegance and technology.





La serie si arricchisce
di tavoli in
"gres porcellanato"
nelle versioni bianco
"extra-white" e nero
"marquinia".



*The series enriches its
finish options with the
"porcelain stoneware"
tables, in the
"extra-white" and
black "marquinia"
versions.*







Tavoli / Tables

Piani di lavoro sp. 1 cm, in vetro temprato retrolaccato con bordi perimetrali lavorati a filo lucido / Worktops 1 cm thick, rear-lacquered tempered glass with outer polished edges



Piani di lavoro sp. 1 cm, in vetro temprato retrolaccato acidato con bordi perimetrali lavorati a filo lucido / Worktops 1 cm thick, rear-lacquered and acetated tempered glass with outer polished edges



Piani di lavoro sp. 1.2 cm, in vetro fumé temprato con bordi perimetrali lavorati a filo lucido / Worktops 1.2 cm thick, smoked grey tempered glass with outer polished edges

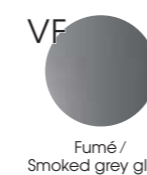

Piano di lavoro in vetro temprato trasparente sp. 0.8 cm, accoppiato con piano in gres porcellanato sp. 0.6 cm / Worktop in 0.8 cm thick transparent tempered glass, coupled with a 0.6 cm thick porcelain stoneware worktop



Gambe metalliche / Metal legs



Mobili di servizio / Service units

Scocca, ripiani sp. 2.5 cm e ante sp. 1.8 cm, in melaminico (*) o laminato (**) / Body, shelves 2.5 cm and doors 1.8 cm thick, in melamine (*) or laminate (**)



Note

■ Prodotti non in pronta consegna. Per la disponibilità contattare l'ufficio commerciale / Items not in prompt delivery. Please contact the commercial department to check availability.

Tavoli scrivania in vetro/Glass tables

P 100 x H 75 V	P 60 x H 75 V	V
903.TV.07.20_ L 200	903.TV.05.10_ L 100	903.TV.04.10_ L 100

Tavoli scrivania in gres/Gres tables

P 100 x H 75 G	P 60 x H 75 G	G
903.TV.07.20_ L 200	903.TV.05.10_ L 100	903.TV.04.10_ L 100

Tavoli per integrazione con mobili di servizio /Desk for integration with service units

P 100 x H 75 V	P 100 x H 75 G
903.TV.09.20_ L 200	903.TV.09.20_ L 200

Tavoli scrivania in vetro L 200 con mobile di servizio P 66 (Dx o Sx)/Glass desks L 200 with service unit D 66 (R or L)

L = L 11 - L 12 - L 13 P 180 x H 75

V	G	
903.TV.6_20_ Sx/L - Dx/R	903.TV.6_20_ Sx/L - Dx/R	

Tavoli scrivania in vetro L 200 con mobile di servizio P 92,5 (Dx o Sx)/Glass desks L 200 with service unit D 92,5 (R or L)

L = L 14 - L 15 - L 16 P 180 x H 75

V	G	
903.TV.9_20_ Sx/L - Dx/R	903.TV.9_20_ Sx/L - Dx/R	

Tavoli scrivania - riunioni in vetro L 160x160 con mobile di servizio P 66 - 92,5 (Dx o Sx) /Glass desks - meeting tables L 160x160 with service unit D 66 - 92,5 (R or L)

L = L 17 P 250 x H 75

V	G	
903.TV.6_20_ Sx/L - Dx/R	903.TV.9_20_ Sx/L - Dx/R	

Canalizzazione in tondino d'acciaio e modesty panels per tavoli in vetro /Wire management with steel rod channels and modesty panels for tables with glass tops

903.AP.15.10_ L 78 Tavoli/Desks L 100 903.AP.15.16_ L 140 Tavoli/Desks L 160 903.AP.15.20_ L 160 Tavoli/Desks 200 903.AP.15.24_ L 160 Tavoli/Desks 240	903.MP.04.12_ L 120 Tavoli + MS/Desks + SU L 200 903.MP.04.14_ L 140 Tavoli + MS/Desks + SU L 200 903.MP.04.16_ L 160 Tavoli + MS/Desks + SU L 200 903.MP.04.10_ L 100 Tavoli + MS/Desks + SU L 160 903.MP.05.16_ L 140 Tavoli/Desks L 160 903.MP.05.20_ L 180 Tavoli/Desks L 200	903.MP.07.20_ L 180 Tavoli/Desks L 200 903.MP.07.16_ L 140 Tavoli/Desks L 160 903.MP.07.12_ L 120 Tavoli + MS/Desks + SU L 200 903.MP.07.14_ L 140 Tavoli + MS/Desks + SU L 200 903.MP.07.18_ L 160 Tavoli + MS/Desks + SU L 200 903.MP.07.10_ L 100 Tavoli + MS/Desks + SU L 160

Cassettiere/Pedestals

L 42 P 57 x H 55,5	L 32,2 P 54,2 x H 55,6	L 42,2 P 54,2 x H 55,6
550.CS.10.04_ Melaminico/Melamine	550.CS.20.04_ Melaminico/Melamine	550.CS.1M.03_ Metalliche/Metallic
		550.CS.2M.03_ Metalliche/Metallic
		550.CS.1M.04_ Metalliche/Metallic
		550.CS.2M.04_ Metalliche/Metallic

Vaschetta porta cancelleria inclusa / Stationery tray included

Note: Per portacancelleria cassetti, vedi capitolo DV300-Accessori/For stationary tray, see chapter DV300-Accessories.

Accessori per canalizzazione - Elettrificazione - Vari/Accessories for wire management - Electrification - Various

300.AC.26.02 L 24,5	300.AC.20.02_ L 24,5	300.AC.25.02 L 23,5	300.AP.S1.02 L 20,5	300.AT.A6.02 L 21	300.AP.T2.01 Ø 8
300.AC.26.03 L 34,5	300.AC.20.03_ L 34,5	300.AC.25.03 L 33,5	300.AP.S1.03 L 30	300.AT.A6.03 L 25,5	300.AP.T7.01 Ø 6
300.AC.26.04 L 44,5	300.AC.20.04_ L 44,5	300.AC.25.04 L 43,5	300.AP.S1.04 L 42	300.AT.A6.04 L 39	300.AP.T8.01 Ø 8

Marsupio/Basket Per/For top access 300.AC.26_

300.AP.V1.00	903.AP.08.00	300.AP.T4.01	300.AP.F1.00	300.AS.01.09_
		300.AP.T5.01 - UK		
		300.AP.T6.01 - US		

Note:

- Le finiture in gres non sono in pronta consegna. Per la disponibilità contattare l'ufficio commerciale /Gres finishes are not in prompt delivery. Please contact the commercial department to check availability;
 - Per la scelta dei contenitori e degli accessori vari, consultare il listino prezzi o catalogo/To choose storage units and accessories, please check correspondent price list or catalogue;
 - Le dimensioni sono espresse in cm - consultare il listino prezzi per le caratteristiche tecniche, i codici degli articoli e delle finiture/Dimensions are stated in cm - for technical characteristics, article code numbers and finishing see price list;
 - I tavoli possono essere montati sui mobili di servizio P 66 e P 92,5 cm (destri o sinistri) scegliendo tra diverse posizioni. Per ogni soluzione compositiva è disponibile a listino la dimensione del corrispondente modesty panel (vedi relativa quota indicata con MP) e del corrispondente canale passacavi (vedi relativa quota indicata con CP)/The desks can be mounted on service units depth 66 and 92,5 cm (right or left hand) in different positions. You can find the proper modesty panel to match according to the composition chosen (see sizes indicated with the MP), while the cable channel is indicated with CP;
- Prodotti non in pronta consegna. Per la disponibilità contattare l'ufficio commerciale/Items not in prompt delivery. Please contact the commercial department to check availability;
 - Fino ad esaurimento/Until exhaustion;
 - Con serratura/With lock;
 - Per eventuali giacenze a magazzino delle precedenti versioni senza top-access, contattare l'ufficio commerciale/To check stock availabilities of table tops without top-access, please contact our commercial department;
 - Vetro/Glass; G Gres/Gres.
 - Gambone in alluminio anodizzato / Metal column made in "Anodized" aluminium;
 - Gambone verniciato a polveri in bianco, alluminio o antracite / Metal column electrostatic painted in white, aluminum or anthracite;

Vertigo

DV901

Eleganza nel design e ricercatezza nei dettagli, sono i tratti distintivi di questa collezione di scrivanie e tavoli riunione, pensata per creare ambienti dove stile e professionalità siano in sintonia con immagine e prestazioni.

Elegant design and refined details are the distinctive features of this collection, conceived to create environments where style and professionalism are in harmony with image and performance.











Bellezza architettonica esaltata attraverso elementi di arredo, caratterizzati da un design inconfondibile. Ogni oggetto al posto giusto denota l'ampia flessibilità della collezione.

Architectonic beauty exalted through furnishing items, characterised by distinctive design. Each element at the right place to underline the wide flexibility of this collection.







Tavoli / Tables

Piani di lavoro sp. 1.8 cm, in melaminico (*) o laminato (**) con bordi in ABS sp. 0.2 cm /
Worktops 1.8 cm thick, in melamine (*) or laminate (**) with ABS edge-profiles 0.2 cm thick

WL (**)	NM (*)	RC (*)	RT (*)	NO (*)
Bianco lucido / Glossy white	Noce "Maroncelli" / "Maroncelli" walnut	Rovere chiaro / Light oak	Rovere tabacco / Tobacco oak	Nero opaco / Matt black

Piani di lavoro sp. 2 cm, in cuoio con cuciture /
Worktop 2 cm thick, in leather with stitches

CBI (■)	CNE (■)	CTM (■)
Cuoio bianco / White hard leather	Cuoio nero / Black hard leather	Cuoio testa di moro / Dark brown hard leather

Piani di lavoro sp. 1 cm, in vetro temprato retrolaccato con bordi perimetrali lavorati a filo lucido /
Worktops 1 cm thick, rear-lacquered tempered glass with outer polished edges

VW (○)
Bianco / White

Piani di lavoro sp. 1 cm, in vetro temprato retrolaccato acidato con bordi perimetrali lavorati a filo lucido /
Worktops 1 cm thick, rear-lacquered and acetated tempered glass with outer polished edges

VAN (●)
Nero / Black

Piano di lavoro in vetro temprato trasparente sp. 0.8 cm, accoppiato con piano in gres porcellanato sp. 0.6 cm /
Worktop in 0.8 cm thick transparent tempered glass, coupled with a 0.6 cm thick porcelain stoneware worktop

VGB (○)	VGN (●)
Bianco extra / Extra white	Nero "Marquinia" / "Marquinia" black

Strutture metalliche / Metal structures

W (○)	H (○)	A (●)
Bianco / White	Alluminio / Aluminium	Antracite / Anthracite

Gambone in metallo con base / Metal column base

HA (○)
Alluminio "Anodizzato" / "Anodized" aluminium

Mobili di servizio / Service units

Scocca, ripiani sp. 2.5 cm e ante sp. 1.8 cm, in melaminico (*) o laminato (**) /
Body, shelves 2.5 cm and doors 1.8 cm thick, in melamine (*) or laminate (**) /

WL (**)	WN (*)	NM (*)	RC (*)	RT (*)	NO (*)
Bianco lucido / Glossy white	Bianco opaco / Matt white	Noce "Maroncelli" / "Maroncelli" walnut	Rovere chiaro / Light oak	Rovere tabacco / Tobacco oak	Nero opaco / Matt black

Note

(■) Prodotti non in pronta consegna. Per la disponibilità contattare l'ufficio commerciale / Items not in prompt delivery. Please contact the commercial department to check availability;

Moduli bancone dritti – Moduli bancone curvi 60° – Moduli bancone raccordo 90°/Straight counter units – 60° curved counter units – 90° counter corner units

P 90 x H 75 901.TS.48.18_L 180 901.TS.48.20_L 200	 901.TS.03.18_L 180 901.TS.03.20_L 200	P 90 x H 74,5 901.TV.17.18_L 180 901.TV.17.20_L 200	 901.TV.01.18_L 180 901.TV.01.20_L 200	P 90 x H 75 901.TS.48.18_L 180 901.TS.48.20_L 200	 901.TS.03.18_L 180 901.TS.03.20_L 200
P 90 x H 74,5 901.TV.17.18_L 180 901.TV.17.20_L 200	 901.TV.01.18_L 180 901.TV.01.20_L 200	L 160 P 80 x H 75 901.TS.02.16_	L 160 P 80 x H 74,5 901.TV.15.16_	L 160 P 80 x H 75 901.TS.02.16_	

Tavoli dattilo/Typing tables

L 120 P 60 x H 75 901.TS.50.12_	 901.TS.44.12_	L 120 P 60 x H 74,5 901.TV.19.12_	 901.TV.16.12_	L 120 P 60 x H 75 901.TS.50.12_	 901.TS.44.12_	L 120 P 60 x H 75 901.TV.19.12_	 901.TV.16.12_
--	-------------------	--	-------------------	--	-------------------	--	-------------------

Tavoli riunione/Meeting tables

Ø 100 x H 74,5 901.TV.14.10_	 901.TV.15.10_	Ø 100 x H 75 901.TV.14.10_	 901.TV.15.10_	L 100 P 100 x H 75 901.TR.42.10_	 901.TR.42.10_	L 160 P 160 x H 75 901.TR.43.16_	L 160 P 160 x H 74,5 901.TV.38.16_
L 160 P 160 x H 75 901.TR.43.16_	 901.TR.51.16_	 901.TR.51.16_	L 240 P 120 x H 75 901.TR.41.24_	L 240 P 120 x H 74,5 901.TV.36.24_	L 240 P 120 x H 75 901.TR.41.24_	L 240 P 120 x H 75,5 901.TV.36.24_	

Allunghi per tavoli scrivania L 160 – 180/Extension tables for desks L 160 – 180

L 120 P 60 x H 75 901.TD.31.12_Dx/R 901.TD.33.12_Sx/L	 901.TD.30.12_Dx/R 901.TD.32.12_Sx/L	L 120 P 60 x H 74,5 901.TV.22.12_Dx/R 901.TV.24.12_Sx/L	 901.TV.21.12_Dx/R 901.TV.23.12_Sx/L	L 120 P 60 x H 75 901.TV.22.12_Dx/R 901.TV.24.12_Sx/L	 901.TV.21.12_Dx/R 901.TV.23.12_Sx/L	L 120 P 60 x H 75 901.TD.31.12_Dx/R 901.TD.33.12_Sx/L	 901.TD.30.12_Dx/R 901.TD.32.12_Sx/L
---	--	---	--	---	--	---	--

Allunghi per tavoli scrivania L 200/Extension tables for desks L 200

L 120 P 60 x H 75 901.TD.27.12_	 901.TD.26.12_	L 120 P 60 x H 74,5 901.TV.20.12_	 901.TV.04.12_	L 120 P 60 x H 75 901.TV.20.12_	 901.TV.04.12_	L 120 P 60 x H 75 901.TD.27.12_	 901.TD.26.12_
--	-------------------	--	-------------------	--	-------------------	--	-------------------

Tavoli riunione componibili con gambe centrali rientrate/Modular meeting tables with central recessed legs

L 320 P 80 x H 75 901.TR.55.32_	 901.TR.55.32_	P 90 x H 75 901.TR.55.36_L 360 901.TR.55.40_L 400	 901.TR.55.36_L 360 901.TR.55.40_L 400	L 320 P 160 x H 75 901.TR.32.32_	 901.TR.52.32_	 901.TR.52.32_	L 480 P 160 x H 75 901.TR.32.48_
L 320 P 160 x H 75 901.TV.47.32_	 901.TR.32.32_	 901.TR.52.32_	 901.TR.52.32_	L 480 P 160 x H 75 901.TV.47.48_	 901.TR.32.48_	 901.TR.52.48_	 901.TR.52.48_

Elementi per tavoli riunione componibili con gambe centrali rientrate/Modular elements for compound meeting tables with central recessed legs

L 160 P 80 x H 75 901.TR.55.16_	 901.TR.55.16_	P 90 x H 75 901.TR.55.18_L 180 901.TR.55.20_L 200	 901.TR.55.18_L 180 901.TR.55.20_L 200
L 160 P 160 x H 75 901.TR.32.16_	 901.TR.32.16_	 901.TR.52.16_	 901.TR.52.16_

Tavoli per integrazione con mobili di servizio/Desks for integration with service units

P 90 x H 75 901.TI.15.18_L 180 901.TI.15.20_L 200	P 90 x H 74,5 901.TV.11.18_L 180 901.TV.11.20_L 200	P 90 x H 75 901.TV.11.18_L 180 901.TV.11.20_L 200	P 90 x H 75 901.TI.15.18_L 180 901.TI.15.20_L 200	L 160 P 160 x H 75 901.TI.16.16_Dx/R 901.TI.17.16_Sx/L	L 160 P 160 x H 74,5 901.TI.22.16_Dx/R 901.TI.23.16_Sx/L
L 160 P 160 x H 75 901.TI.16.16_Dx/R 901.TI.17.16_Sx/L	L 160 P 160 x H 75 901.TI.18.16_Dx/R 901.TI.19.16_Sx/L	L 160 P 160 x H 75 901.TI.18.16_Dx/R 901.TI.19.16_Sx/L			

Note:

- 1 Le finiture gres e cuoio non sono in pronta consegna. Per la disponibilità contattare l'ufficio commerciale/ Porcelain stoneware and leather finishes are not in prompt delivery. Please contact the commercial department to check availability;
- 2 Le dimensioni sono espresse in cm – consultare il listino prezzi per le caratteristiche tecniche, i codici degli articoli e delle finiture/Dimensions are stated in cm – for technical characteristics, article code numbers and finishing see price list;
- 3 Prodotti non in pronta consegna. Per la disponibilità contattare l'ufficio commerciale/items not in prompt delivery. Please contact the commercial department to check availability;
- 4 Fino ad esaurimento/Until exhaustion;
- 5 Per eventuali giacenze a magazzino delle precedenti versioni senza top-access, contattare l'ufficio commerciale /To check stock availabilities of table tops without top-access, please contact our commercial department;
- 6 Gambone in alluminio anodizzato / Metal column made in "Anodized" aluminium;
- 7 Gambone verniciato a polveri in bianco, alluminio o antracite / Metal column electrostatic painted in white, aluminum or anthracite;
- 8 Vetro/Glass; C Cuoio/Leather; G Gres/Gres;
- 9 Allunghi montabili anche in posizione centrale sui tavoli scrivania L 160 – 180 – 200 (vedere listino)/Extensions suitable also for central position on desks L 160 – 180 – 200 (see price list);
- 10 Tavoli scrivania con piani composti /Desks with compound worktops.

Esempi posizionamento tavoli riunione P 90 con mobili di servizio/Examples of meeting tables D 90 positioning with service units

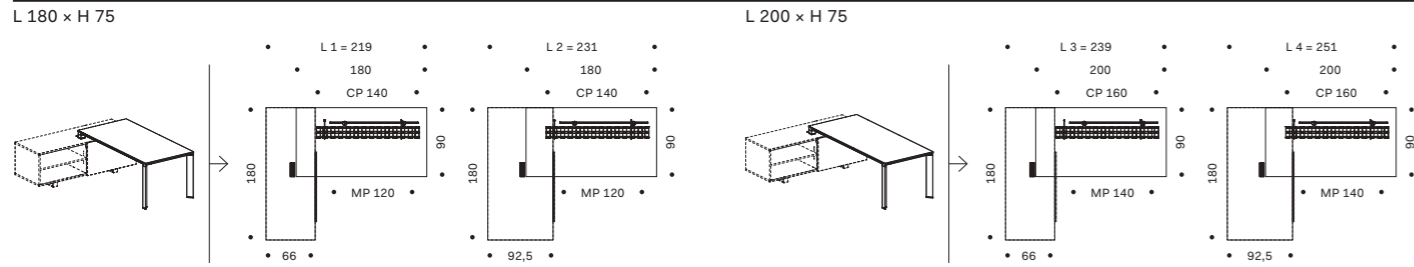

Esempi posizionamento tavoli riunione L 160 con mobili di servizio/Examples of meeting tables W 160 positioning with service units

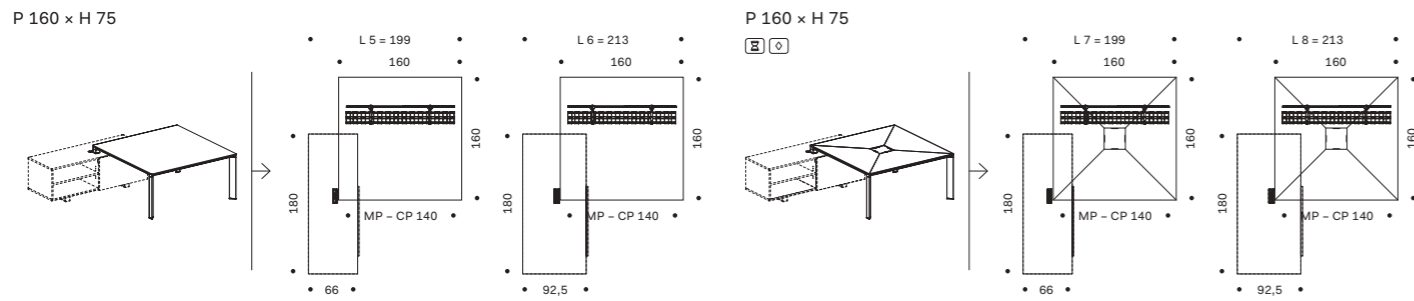

Mobili di servizio e cassetiera interna/Service units and internal pedestals

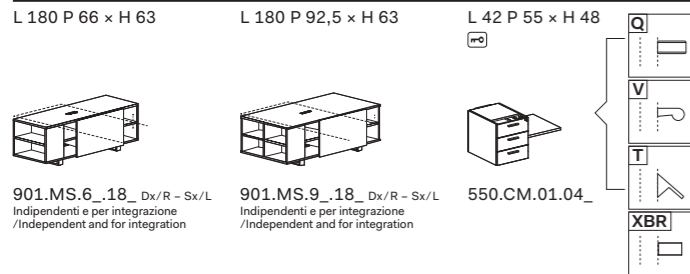

Note: La finitura nero opaco non è in pronta consegna, per la disponibilità contattare l'ufficio commerciale./Matt black finishes is not in prompt delivery. Please contact the commercial department to check availability.

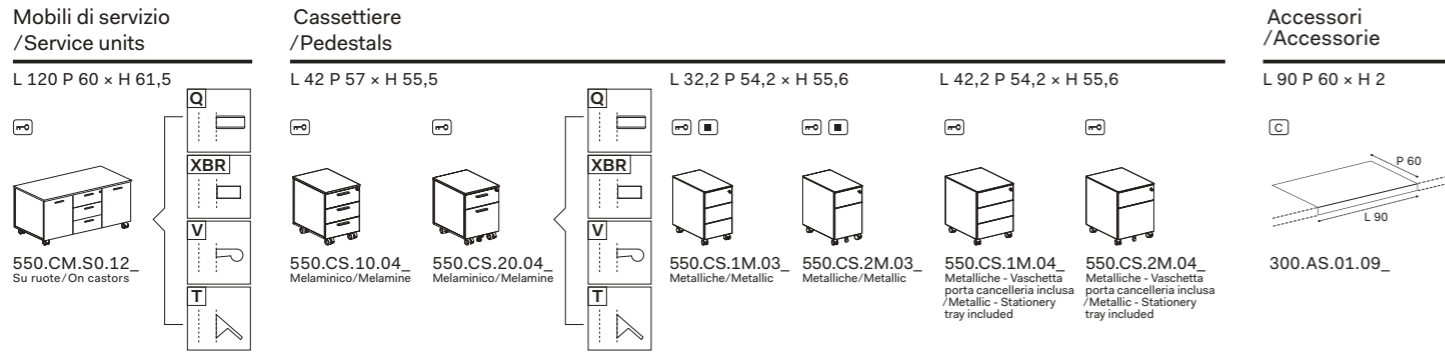

Note: Per portacancelleria cassette, vedi capitolo DV300-Accessori/For stationary tray, see chapter DV300-Accessories.

Modesty panel - Canalizzazione per tavoli scrivanie/Modesty panel - Wire management for desks

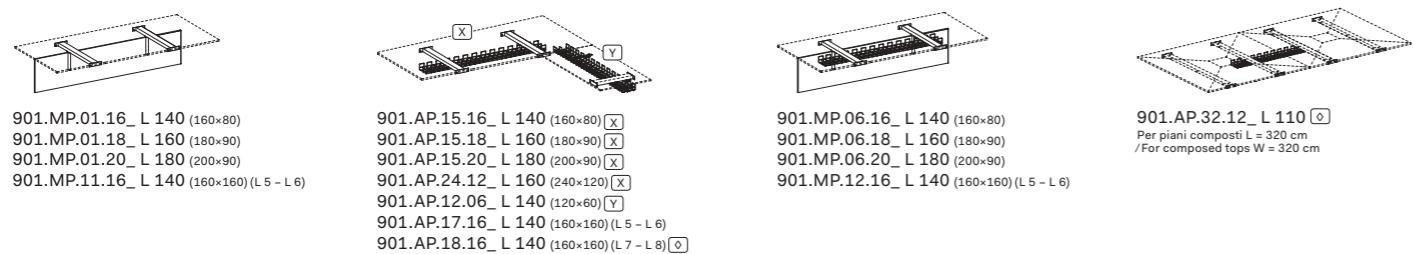

Modesty panel - Canalizzazione per tavoli scrivanie su mobili di servizio/Modesty panel - wire management for desks on service units

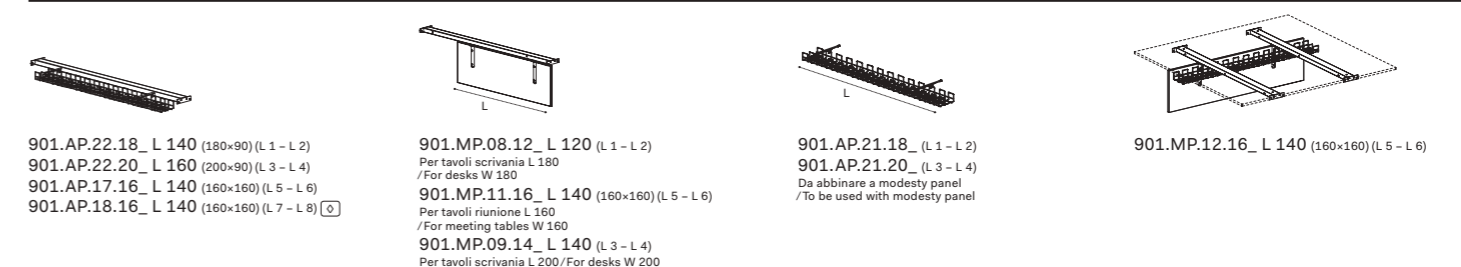

Modesty panel in cuoio per tavoli scrivanie /Leather modesty panel for desks

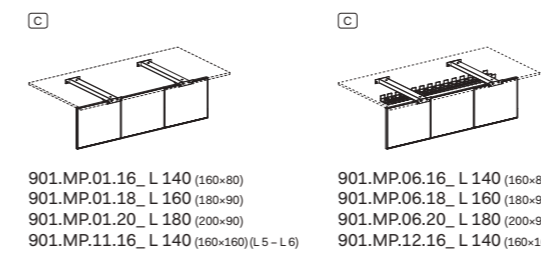

Modesty panel in cuoio per tavoli scrivanie su mobili di servizio /Leather modesty panel for desks on service units

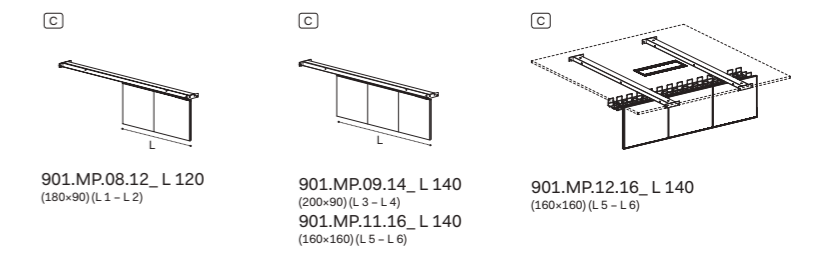

Accessori per canalizzazione - Elettrificazione - Vari/Accessories for wire management - Electrification - Various

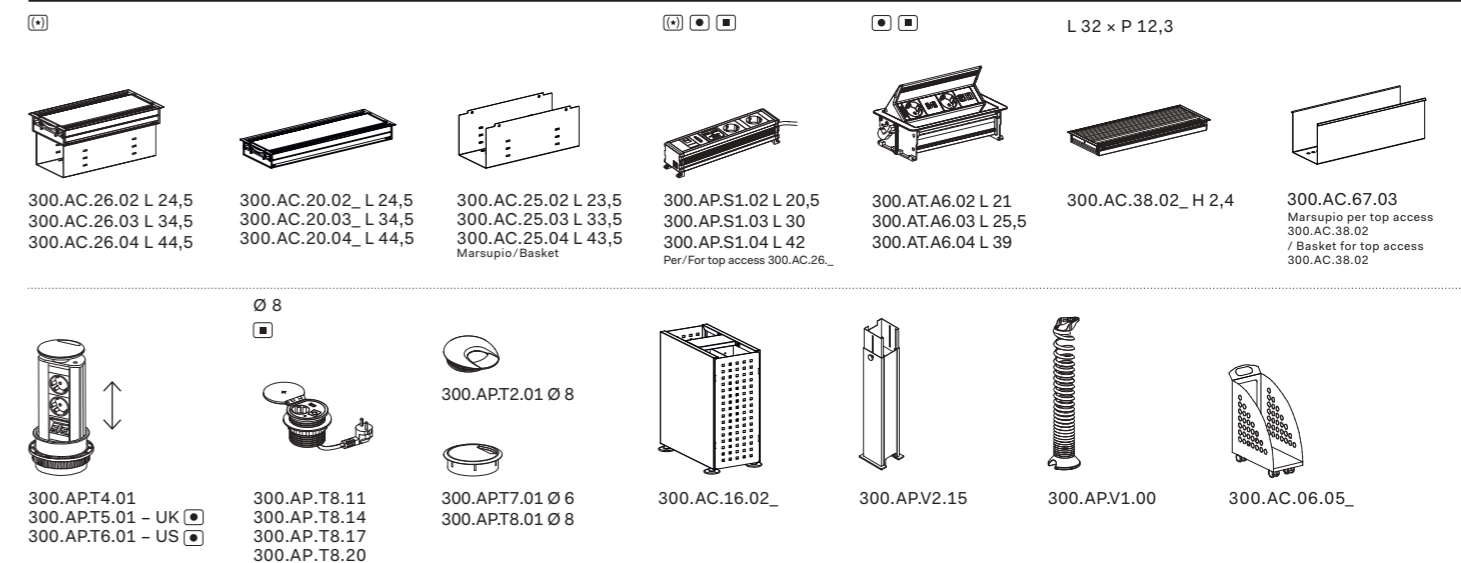

Bracci porta video /Arms for video support

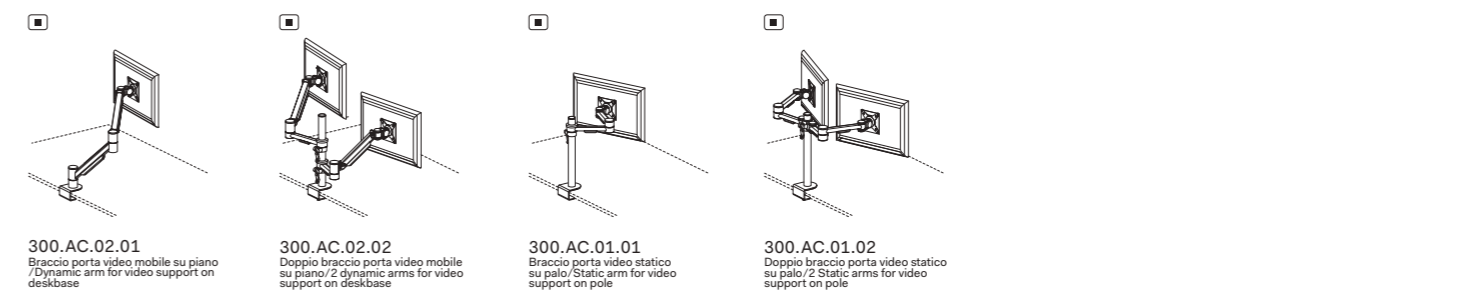

- Note:
- 1 Le finiture gres e cuoio non sono in pronta consegna. Per la disponibilità contattare l'ufficio commerciale/ Porcelain stoneware and leather finishes are not in prompt delivery. Please contact the commercial department to check availability;
 - 2 Le dimensioni sono espresse in cm - consultare il listino prezzi per le caratteristiche tecniche, i codici degli articoli e delle finiture/Dimensions are stated in cm - for technical characteristics, article code numbers and finishing see price list;
 - 3 Per la scelta dei contenitori e degli accessori vari, consultare il relativo listino o catalogo/To choose storage units and accessories, please check correspondent price list or catalogue;
 - 4 Prodotti non in pronta consegna. Per la disponibilità contattare l'ufficio commerciale/items not in prompt delivery. Please contact the commercial department to check availability;
 - 5 Articoli prodotti solo su richiesta/Items produced only on demand;
 - 6 Con serratura/With lock;
 - 7 Tavoli scrivania con piani composti /Desks with compound worktops.
 - 8 Cuoio/Leather;

Planeta

DV902

La collezione accogliente e confortevole, si esalta attraverso le svariate finiture cromatiche disponibili, che rendono questa serie attuale e senza tempo. Una linea direzionale elegante e minimale che si distingue per la funzionalità e le diverse profondità dei mobili di servizio portanti.

Cozy and comfortable collection, exalted through a number of available colors and finishes that make this series alive and timeless. This elegant, minimalist executive range stands out for functionality and for the different depths of the carrying service units.







Focus e dettagli sulla funzionalità del mobile di servizio in laminato bianco lucido.



Focus and details on the functionalities of the white gloss laminate service unit.



Tavoli / Tables

Plani di lavoro sp. 1.8 cm, in melaminico (*) o laminato (***) con bordi in ABS sp. 0.2 cm / Worktops 1.8 cm thick, in melamine (*) or laminate (***) with ABS edge-profiles 0.2 cm thick



Plani di lavoro sp. 2 cm, in cuoio con cuciture / Worktop 2 cm thick, in leather with stitches



Plani di lavoro sp. 1 cm, in vetro temprato retrolaccato con bordi perimetrali lavorati a filo lucido / Worktops 1 cm thick, rear-lacquered tempered glass with outer polished edges



Plani di lavoro sp. 1 cm, in vetro temprato retrolaccato acidato con bordi perimetrali lavorati a filo lucido / Worktops 1 cm thick, rear-lacquered and acetated tempered glass with outer polished edges



Piano di lavoro in vetro temprato trasparente sp. 0.8 cm, accoppiato con piano in gres porcellanato sp. 0.6 cm / Worktop in 0.8 cm thick transparent tempered glass, coupled with a 0.6 cm thick porcelain stoneware worktop



Strutture metalliche / Metal structures

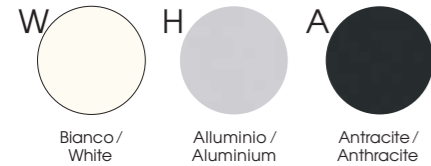

Gambone in metallo con base / Metal column base



Mobili di servizio / Service units

Scocca, ripiani sp. 2.5 cm e ante sp. 1.8 cm, in melaminico (*) o laminato (***) / Body, shelves 2.5 cm and doors 1.8 cm thick, in melamine (*) or laminate (***)

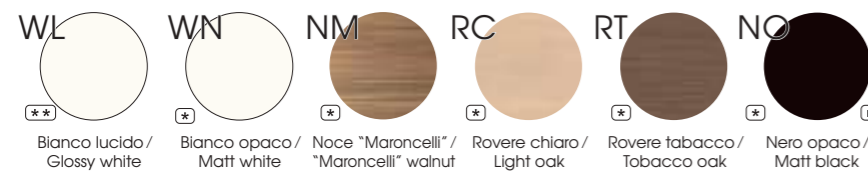

Note

Prodotti non in pronta consegna. Per la disponibilità contattare l'ufficio commerciale / Items not in prompt delivery. Please contact the commercial department to check availability.

Tavoli scrivania L 180 con mobile di servizio P 66 (Dx o Sx) / Desks W 180 with service unit D 66 (R or L)

P 180 x H 75 V	P 180 x H 74 V	P 180 x H 75 G	P 180 x H 75 C	Schema delle 3 posizioni di montaggio / Scheme of 3 assembling solutions
902.TM.6_18_ Sx/L - Dx/R	902.TV.6_18_ Sx/L - Dx/R	902.TV.6_18_ Sx/L - Dx/R	902.TM.6_18_ Sx/L - Dx/R	
902.PM.6_18_ Sx/L - Dx/R	902.PV.6_18_ Sx/L - Dx/R	902.PV.6_18_ Sx/L - Dx/R	902.PM.6_18_ Sx/L - Dx/R	Soluzione base / Suggested solution

Tavoli scrivania L 200 con mobile di servizio P 66 (Dx o Sx) / Desks W 200 with service unit D 66 (R or L)

P 180 x H 75 V	P 180 x H 74 V	P 180 x H 75 G	P 180 x H 75 C	Schema delle 3 posizioni di montaggio / Scheme of 3 assembling solutions
902.TM.6_20_ Sx/L - Dx/R	902.TV.6_20_ Sx/L - Dx/R	902.TV.6_20_ Sx/L - Dx/R	902.TM.6_20_ Sx/L - Dx/R	
902.PM.6_20_ Sx/L - Dx/R	902.PV.6_20_ Sx/L - Dx/R	902.PV.6_20_ Sx/L - Dx/R	902.PM.6_20_ Sx/L - Dx/R	Soluzione base / Suggested solution

Tavoli scrivania L 180 con mobile di servizio P 92,5 (Dx o Sx) / Desks W 180 with service unit D 92,5 (R or L)

P 180 x H 75 V	P 180 x H 74 V	P 180 x H 75 G	P 180 x H 75 C	Schema delle 3 posizioni di montaggio / Scheme of 3 assembling solutions
902.TM.9_18_ Sx/L - Dx/R	902.TV.9_18_ Sx/L - Dx/R	902.TV.9_18_ Sx/L - Dx/R	902.TM.9_18_ Sx/L - Dx/R	
902.PM.9_18_ Sx/L - Dx/R	902.PV.9_18_ Sx/L - Dx/R	902.PV.9_18_ Sx/L - Dx/R	902.PM.9_18_ Sx/L - Dx/R	Soluzione base / Suggested solution

Tavoli scrivania L 200 con mobile di servizio P 92,5 (Dx o Sx) / Desks W 200 with service unit D 92,5 (R or L)

P 180 x H 75 V	P 180 x H 74 V	P 180 x H 75 G	P 180 x H 75 C	Schema delle 3 posizioni di montaggio / Scheme of 3 assembling solutions
902.TM.9_20_ Sx/L - Dx/R	902.TV.9_20_ Sx/L - Dx/R	902.TV.9_20_ Sx/L - Dx/R	902.TM.9_20_ Sx/L - Dx/R	
902.PM.9_20_ Sx/L - Dx/R	902.PV.9_20_ Sx/L - Dx/R	902.PV.9_20_ Sx/L - Dx/R	902.PM.9_20_ Sx/L - Dx/R	Soluzione base / Suggested solution

Note:

Le finiture gres e cuoio non sono in pronta consegna. Per la disponibilità contattare l'ufficio commerciale / Porcelain stoneware and leather finishes are not in prompt delivery. Please contact the commercial department to check availability.

I tavoli possono essere montati sui mobili di servizio (destri o sinistri) scegliendo tra 3 diverse posizioni. Per ogni soluzione compositiva è disponibile la dimensione del corrispondente modesty panel (vedi relativa quota indicata con MP) mentre il canale passacavi si ordina secondo la lunghezza del piano di

lavoro utilizzato / The desks can be mounted on service units (right or left hand) in 3 different positions. Find the proper modesty panel to match the chosen composition (see sizes indicated with MP), while the cable channels change according to the size of the worktop;

Le dimensioni sono espresse in cm - consultare il listino prezzi per le caratteristiche tecniche, i codici degli articoli e delle finiture / Dimensions are stated in cm - for technical characteristics, article code numbers and finishing see price list;

Prodotti non in pronta consegna. Per la disponibilità contattare l'ufficio commerciale / Items not in prompt delivery. Please contact the commercial department to check availability.

Articolo subordinato a commessa minima. Previsto anche nella versione con fori e tappi passacavi (Optional - Vedere listino) / Item tied-up to a minimum quantity production. Also foreseen in a version including holes and out-let lids. (Optional - Refer to price list);

Vetro/Glass; Cuoio/Leather; Gres/Gres.

Tavoli per composizioni/Desks for compositions

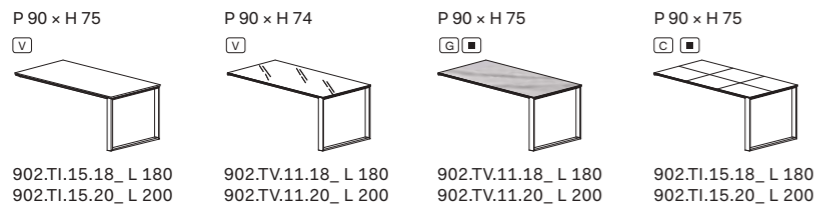

Tavoli riunione/Meeting tables

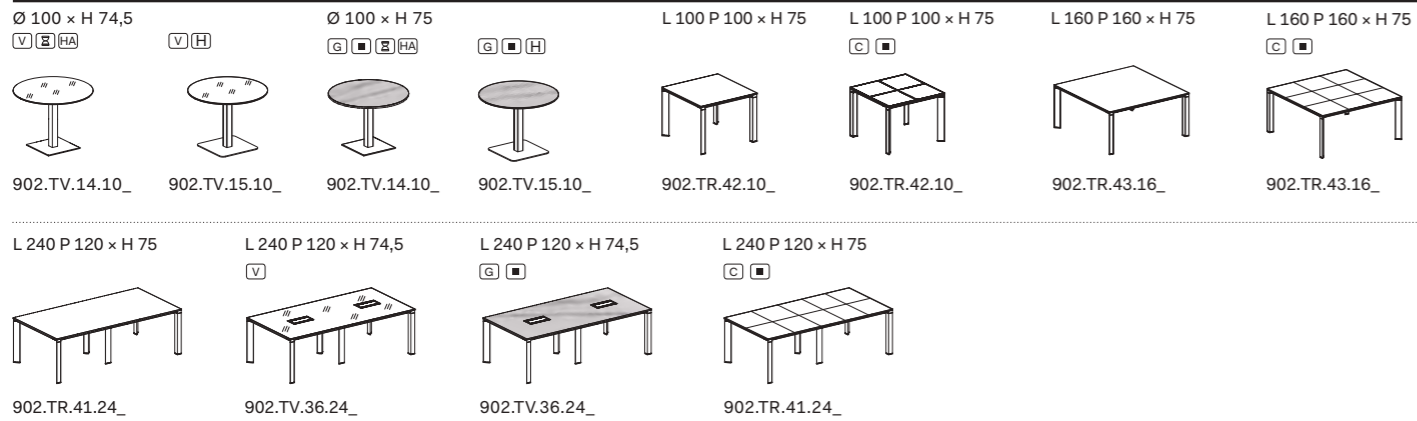

Tavoli riunione componibili con gambe centrali rientrate/Modular meeting tables with central recessed legs

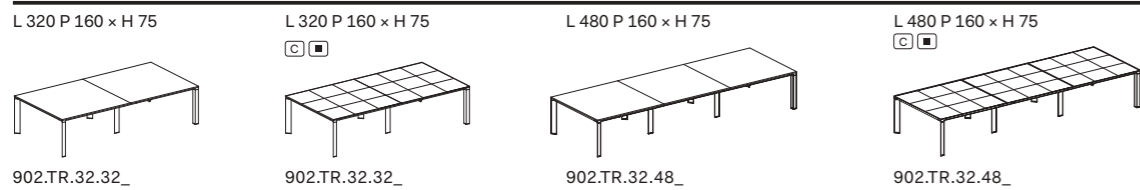

Elementi per tavoli riunioni componibili con gambe centrali rientrate/Modular elements for compound meeting tables with central recessed legs

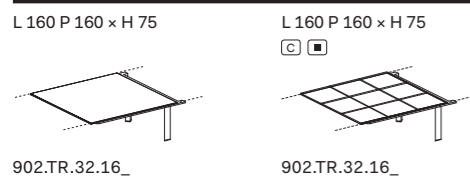

Modesty panel - canalizzazione per tavoli scrivanie su mobili di servizio/Modesty panel - wire management for desks on service units

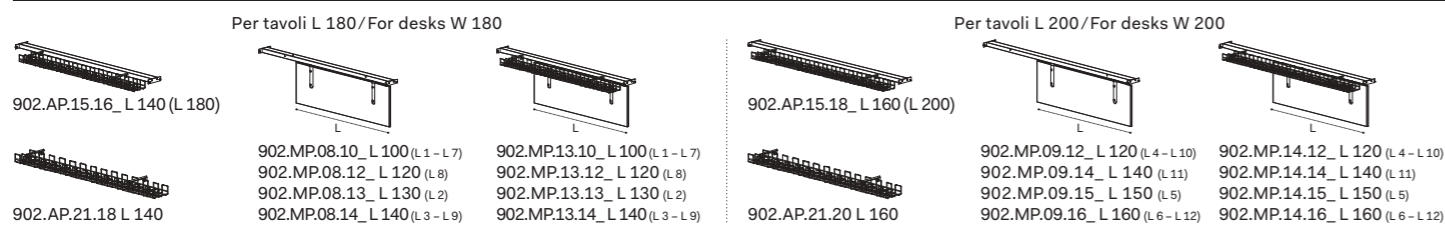

Modesty panel in cuoio /Leather modesty panel

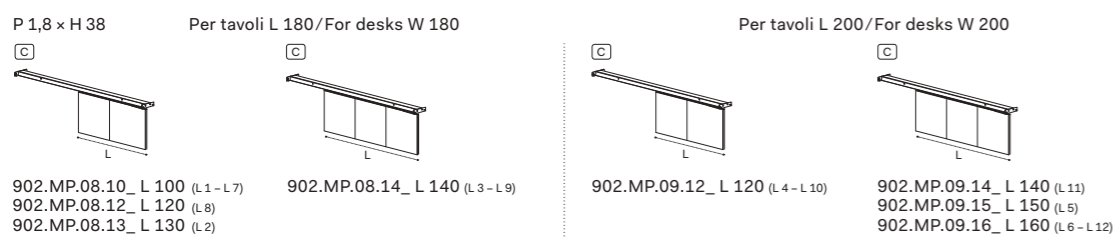

Accessori /Accessories

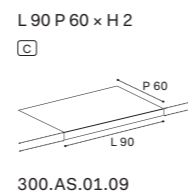

Canalizzazione per tavoli scrivanie/Wire management for desks



Cassettiere/Pedestals

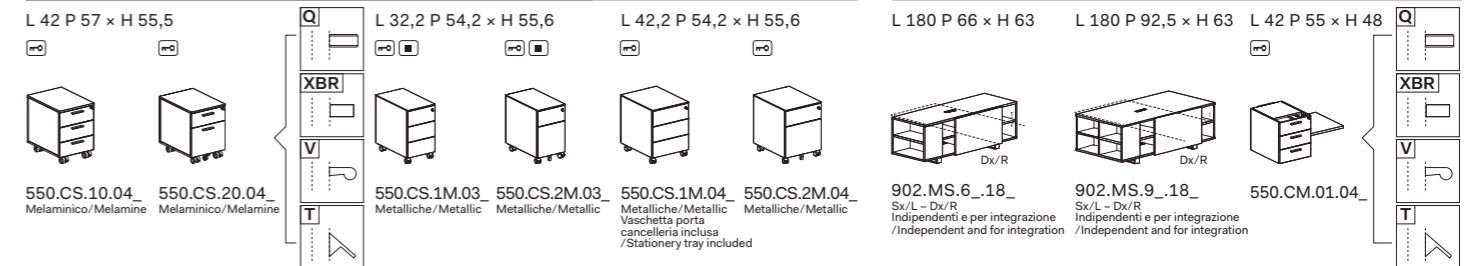

Note: Per portacancelleria cassetta, vedi capitolo DV300-Accessori/For stationary tray, see chapter DV300-Accessories.

Note: La finitura nero opaco non è in pronta consegna, per la disponibilità contattare l'ufficio commerciale. /Matt black finishes is not in prompt delivery. Please contact the commercial department to check availability.

Accessori per canalizzazione - Elettrificazione - Vari/Accessories for wire management - Electrification - Various

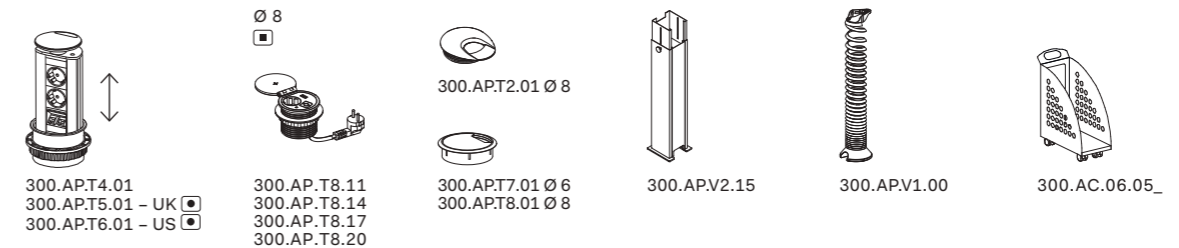
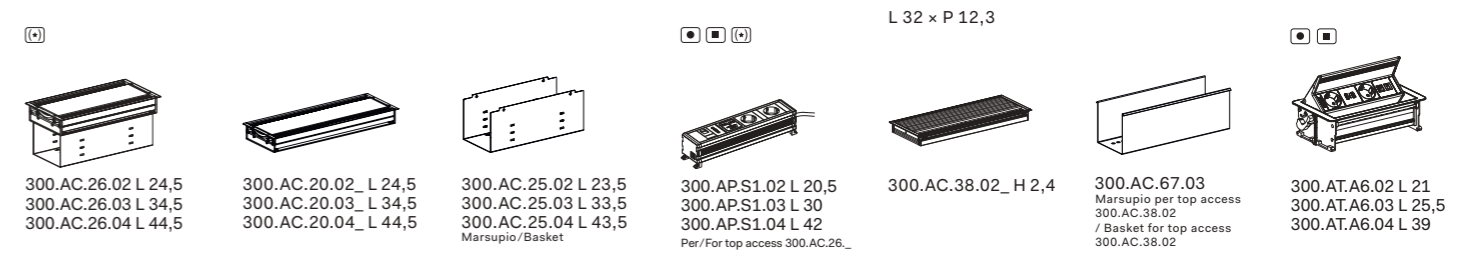

Bracci porta video/Arms for video support

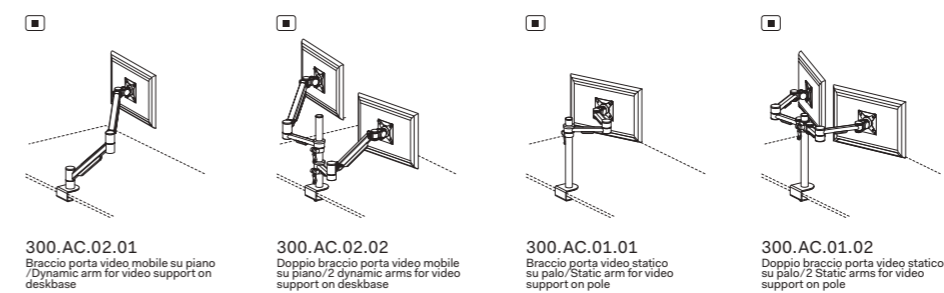

Note:

- Le finiture gres e cuoio non sono in prontaconsegna. Per la disponibilità contattare l'ufficio commerciale/Porcelain stoneware and leather finishes are not in prompt delivery. Please contact the commercial department to check availability;
 - Per la scelta dei contenitori e degli accessori vari, consultare il relativo listino o catalogo/To choose storage units and accessories, please check correspondent price list or catalogue;
 - Le dimensioni sono espresse in cm - consultare il listino prezzi per le caratteristiche tecniche, i codici degli articoli e delle finiture/Dimensions are stated in cm - for technical characteristics, article code numbers and finishing see price list;
- Prodotti non in pronta consegna. Per la disponibilità contattare l'ufficio commerciale/Items not in prompt delivery. Please contact the commercial department to check availability;
 - Articoli prodotti solo su richiesta/Items produced only on demand;
 - Gambone in alluminio anodizzato / Metal column made in "Anodized" aluminium;
 - Gambone verniciato a polveri in bianco, alluminio o antracite /Metal column electrostatic painted in white, aluminum or anthracite;
 - Gres/Gres;
 - Cuoio/Leather;
 - Vetro/Glass;
 - Con serratura/With lock;

Oxford

DV910

È un sistema direzionale composto da una ampia gamma di elementi di arredo in grado di risolvere le esigenze progettuali più svariate. L'effetto minimale viene stemperato e nel contempo valorizzato dalle combinazioni fra le finiture.

It is an executive system composed of a wide range of furnishing elements able to solve the most varied design needs. The minimal effect is softened and at the same time enhanced by the combinations of finishes.





Focus e dettagli sulla funzionalità del piano scrivania con apertura a scorrimento per la canalizzazione.



Focus and details on the functionality of the worktop with sliding opening for channeling.











Dettagli del tavolo Oxford, regolabile elettrico / Details of the Oxford table, electric adjustable



Da H. 77 ÷ 142 cm / From H. 30 5/16" ÷ 55 14/16"

Tavoli / Tables

Piani di lavoro sp. 3.8 cm, in melaminico con bordi in ABS sp. 0.2 cm / Worktops 3.8 cm thick, in melamine with ABS edge-profiles 0.2 cm thick

Piano di lavoro effetto pelle sp. 3.8 cm / Leather effect worktop 3.8 cm thick

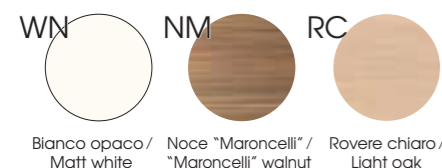

Piano frontale dei piani composti - Gambe pannellate e struttura in melaminico sp. 3.8 cm / Frontal melamine worktops (for compound worktops) - Melamine panelled legs and frame 3.8 cm thick

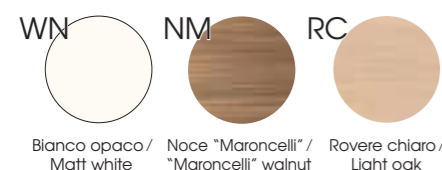

Modesty panel in melaminico sp. 2.5 cm / Melamine modesty panel 2.5 cm thick

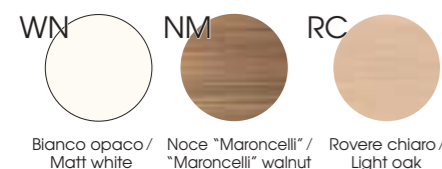

Contenitori multifunzione e Mobili di servizio / Multi - purpose storage unit and Service units

Scocche in melaminico / Melamine shells

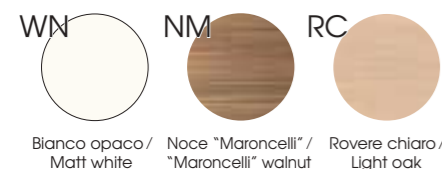

Ante mobile di servizio, contenitore multifunzione e frontali cassetiera sp. 1.8 cm - Sportello apribile mobile di servizio sp. 2.5 cm / Service unit, multi-purpose unit doors and drawers front panel 1.8 cm thick - Service unit flip door 2.5 cm thick



Schiena pinnabile in tessuto 100% poliestere Trevira CS - JET Bioactive / Pinnable back panel with 100% polyester Trevira CS - JET Bioactive fabric

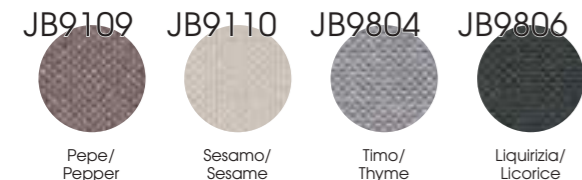

Note

■ Prodotti non in pronta consegna. Per la disponibilità contattare l'ufficio commerciale / Items not in prompt delivery. Please contact the commercial department to check availability;

Tavoli scrivania H 75 / Desks tables H 75

P 90 x H 75
CM

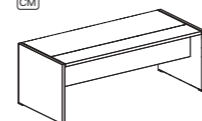

910.TS.68.20_ L 204
910.TS.68.22_ L 224

P 90 x H 75
CM

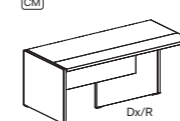

910.TS.59.20_ L 200 Dx/R - Sx/L
910.TS.59.22_ L 220 Dx/R - Sx/L

Tavoli scrivania H 75 su allungo H 71 / Tables H 75 on lateral extension H 71

P 210 x H 75
CM

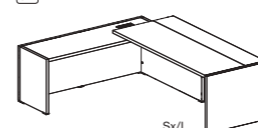

910.TM.42.23_ L 230 Dx/R - Sx/L
910.TM.42.25_ L 250 Dx/R - Sx/L

Tavoli scrivania con allungo H 75 / Tables with lateral extension H 75

P 210 x H 75
CM

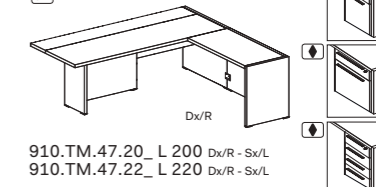

910.TM.47.20_ L 200 Dx/R - Sx/L
910.TM.47.22_ L 220 Dx/R - Sx/L

Tavoli scrivania H 75 con mobile di servizio H 65 con anta scorrevole / Tables H 75 with service unit H 65 with sliding door

P 210 x H 75
CM

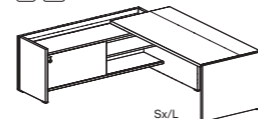

910.TM.32.23_ L 230 Dx/R - Sx/L
910.TM.32.25_ L 250 Dx/R - Sx/L

CM

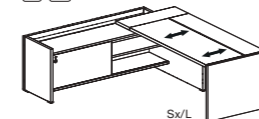

910.TM.33.23_ L 230 Dx/R - Sx/L
910.TM.33.25_ L 250 Dx/R - Sx/L

Tavolini caffè / Coffee tables

P 60 x H 45

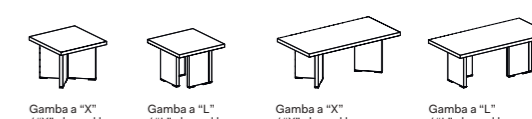

Gamba a "X" / "X" shaped leg
Gamba a "L" / "L" shaped leg
Gamba a "X" / "X" shaped leg
Gamba a "L" / "L" shaped leg
910.TT.03.06_ L 60
910.TT.03.12_ L 120

Tavoli riunione / Meeting tables

L 140 P 140 x H 75

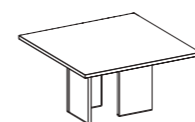

910.TR.38.14_

L 240 P 120 x H 75

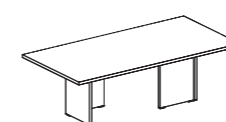

910.TR.41.24_

Raccordo / Connection element

Ø 120 x H 75

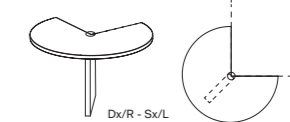

910.PE.01.12_

Tavoli scrivania regolabili in altezza a tre stadi elettricamente da H 77÷142 cm / Desks adjustable in H electrical at three stages from H 77 to H 142 cm

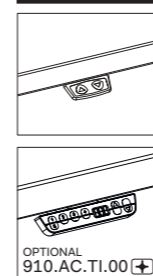

P 90 x H 77 ÷ 142
CM

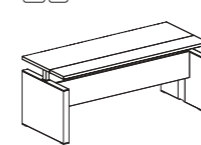

910.TS.69.20_ L 200
910.TS.69.22_ L 220

P 214 x H 77 ÷ 142
CM

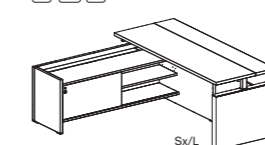

910.TM.34.20_ L 200 Dx/R - Sx/L
910.TM.34.22_ L 220 Dx/R - Sx/L

P 214 x H 77 ÷ 142
CM

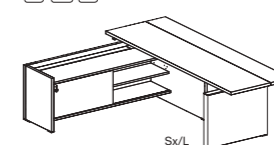

910.TM.34.27_ L 270 Dx/R - Sx/L

Catena passacavi / Cable management chain

L 120 P 5 x H 3

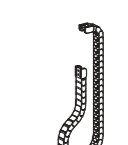

910.AP.10.00

Note:

- 1 Le finiture in melaminico effetto pelle non sono in pronta consegna. Per la disponibilità contattare l'ufficio commerciale; / The melamine leather-effect finishes are not in prompt delivery. Please contact the commercial department to check availability;
- 2 Le dimensioni sono espresse in cm - consultare il listino prezzi per le caratteristiche tecniche, i codici degli articoli e delle finiture / Dimensions are stated in cm - for technical characteristics, article code numbers and finishing see price list;

- 3 Sotto i piani in allungo delle composizioni con il mobile multifunzione è possibile integrare le cassetiere 910.EC.03_ e 910.EC.04.04 / It is possible to integrate 910.EC.03_ and 910.EC.04.04 pedestals under the extension worktops of the compositions with multi-purpose storage unit.
- 4 Prodotti non in pronta consegna. Per la disponibilità contattare l'ufficio commerciale / Items not in prompt delivery. Please contact the commercial department to check availability;

- CM Piano composto / Compound worktop.
- CM Piano composto sliding / Sliding compound worktop.
- ⊕ Tastierino per regolazione altezza piano con memorie / Control pad with memories for height adjustable worktop.
- CM Con serratura / With lock.

Contenitore multifunzione / Multi-purpose storage unit

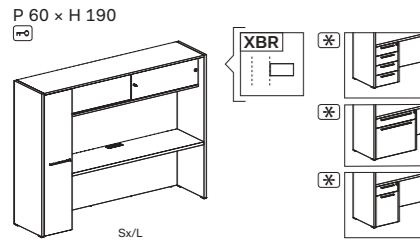

910.HC.01.25_ L 250 Dx/R - Sx/L

Composizioni con piano composto / Compositions with compound worktop

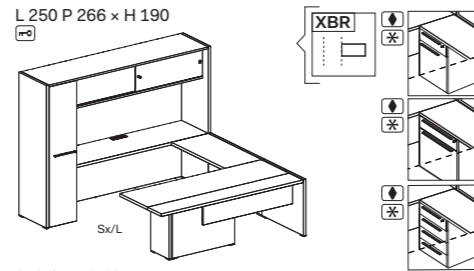

910.CM.P2.20_ Dx/R - Sx/L
910.CM.P2.22_ Dx/R - Sx/L

Accessori contenitore multifunzione / Accessories multi-purpose storage unit

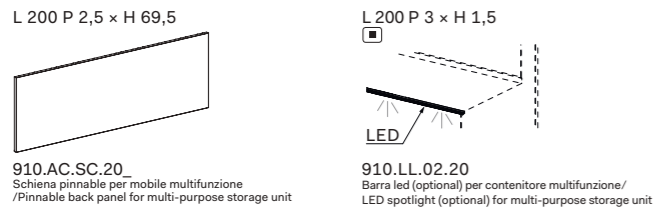

910.AC.SC.20_ Schiena pinnabile per mobile multifunzione / Pinnable back panel for multi-purpose storage unit

910.LL.02.20 Barra led (optional) per contenitore multifunzione / LED spotlight (optional) for multi-purpose storage unit

Cassettiere per contenitori / Pedestals for wardrobe

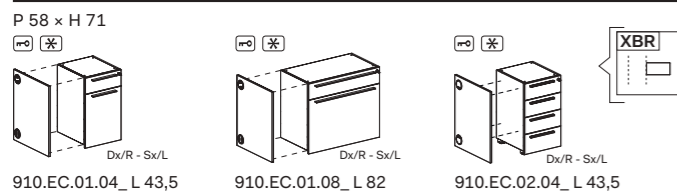

910.EC.01.04_ L 43,5
910.EC.01.08_ L 82
910.EC.02.04_ L 43,5

Cassettiere per allunghi / Pedestals for extension tables

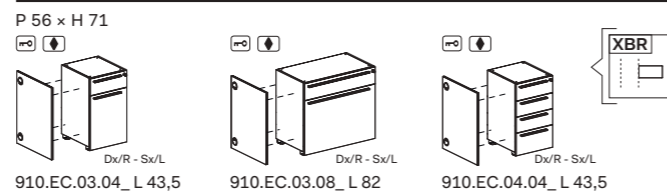

910.EC.03.04_ L 43,5
910.EC.03.08_ L 82
910.EC.04.04_ L 43,5

Cassetti metallici / Metallic drawer

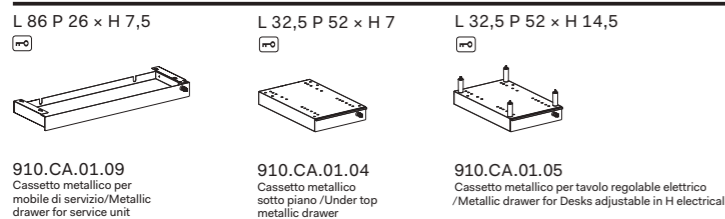

910.CA.01.09 Cassetto metallico per mobile di servizio / Metallic drawer for service unit
910.CA.01.04 Cassetto metallico sotto piano / Under top metallic drawer
910.CA.01.05 Cassetto metallico per tavolo regolabile elettrico / Metallic drawer for Desks adjustable in H electrical

Accessori mobile di servizio / Accessories service unit

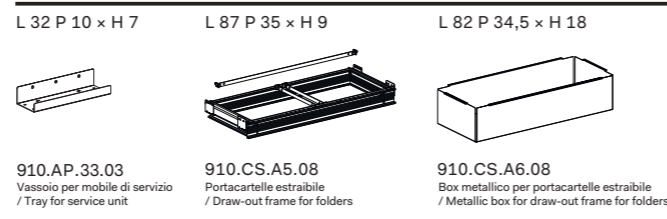

910.AP.33.03 Vassoio per mobile di servizio / Tray for service unit
910.CS.A5.08 Portacartelle estraibile / Draw-out frame for folders
910.CS.A6.08 Box metallico per portacartelle estraibile / Metallic box for draw-out frame for folders

Cassettiere su ruote / Pedestals on castors

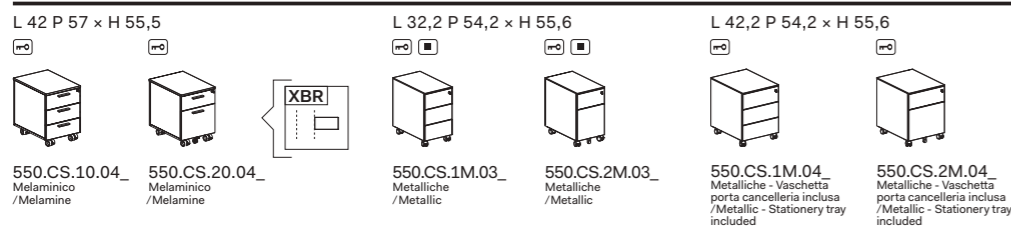

550.CS.10.04 Melaminico / Melamine
550.CS.20.04 Melaminico / Melamine
550.CS.1M.03 Metalliche / Metallic
550.CS.2M.03 Metalliche / Metallic
550.CS.1M.04 Metalliche - Vaschetta porta cancelleria inclusa / Metallic - Stationery tray included
550.CS.2M.04 Metalliche - Vaschetta porta cancelleria inclusa / Metallic - Stationery tray included

Note: Per portacancelleria cassetti, vedi capitolo DV300-Accessori / For stationary tray, see chapter DV300-Accessories.

Note:

- 1 Le finiture in melaminico effetto pelle non sono in pronta consegna. Per la disponibilità contattare l'ufficio commerciale. / The melamine leather-effect finishes are not in prompt delivery. Please contact the commercial department to check availability;
- 2 Le dimensioni sono espresse in cm - consultare il listino prezzi per le caratteristiche tecniche, i codici degli articoli e delle finiture. / Dimensions are stated in cm - for technical characteristics, article code numbers and finishing see price list;
- 3 Sotto i piani dei contenitori multifunzione è possibile integrare le cassettiere 910.EC.01... e 910.EC.02.04 / It is possible to integrate 910.EC.01... and 910.EC.02.04 pedestals under the worktops of the multi-purpose storage unit.
- 4 Sotto i piani in allungo delle composizioni con il mobile multifunzione è possibile integrare le cassettiere 910.EC.03... e 910.EC.04.04 / It is possible to integrate 910.EC.03... and 910.EC.04.04 pedestals under the extension worktops of the compositions with multi-purpose storage unit.
- 5 Prodotti non in pronta consegna. Per la disponibilità contattare l'ufficio commerciale. / Items not in prompt delivery. Please contact the commercial department to check availability;
- 6 Con serratura / With lock.

Accessori per canalizzazione - Elettrificazione - Vari / Accessories for wire management - Electrification - Various

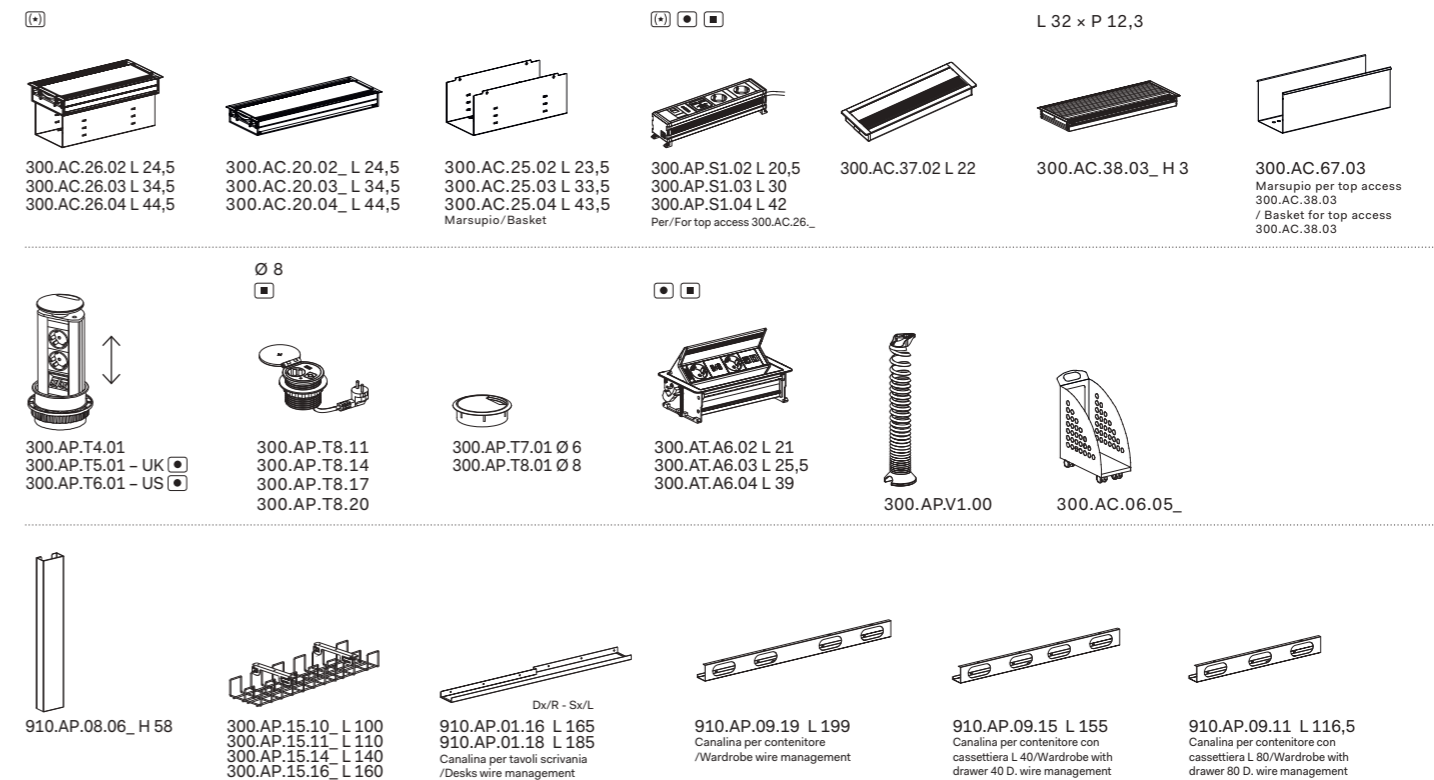

300.AC.26.02 L 24,5
300.AC.26.03 L 34,5
300.AC.26.04 L 44,5
300.AC.20.02_ L 24,5
300.AC.20.03_ L 34,5
300.AC.20.04_ L 44,5
300.AC.25.02 L 23,5
300.AC.25.03 L 33,5
300.AC.25.04 L 43,5
Marsupio / Basket
300.AP.S1.02 L 20,5
300.AP.S1.03 L 30
300.AP.S1.04 L 42
Per / For top access 300.AC.26...
300.AC.37.02 L 22
300.AC.38.03_ H 3
300.AC.67.03 Marsupio per top access / Basket for top access
300.AC.38.03 / Basket for top access
300.AC.38.03

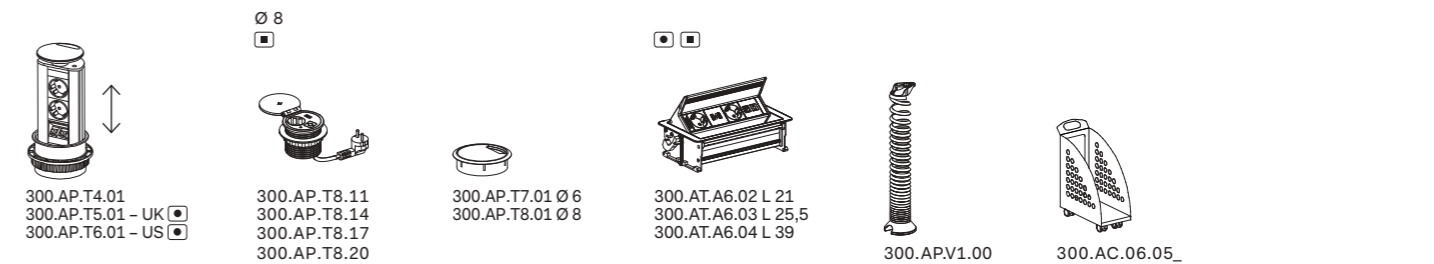

300.AP.T4.01
300.AP.T5.01 - UK
300.AP.T6.01 - US
300.AP.T8.11
300.AP.T8.14
300.AP.T8.17
300.AP.T8.20
300.AP.T7.01 Ø 6
300.AP.T8.01 Ø 8
300.AT.A6.02 L 21
300.AT.A6.03 L 25,5
300.AT.A6.04 L 39
300.AP.V1.00
300.AC.06.05_

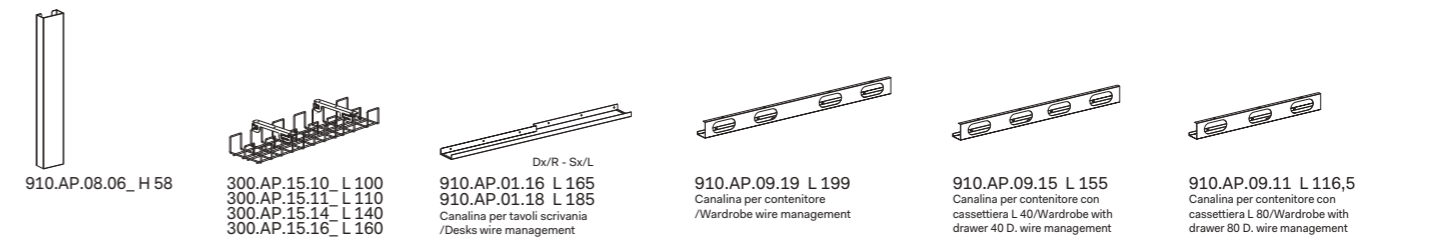

910.AP.08.06_ H 58
300.AP.15.10_ L 100
300.AP.15.11_ L 110
300.AP.15.14_ L 140
300.AP.15.16_ L 160
910.AP.01.16 L 165
910.AP.01.18 L 185
Canalina per tavoli scrivania / Desks wire management
910.AP.09.19 L 199
Canalina per contenitore / Wardrobe wire management
910.AP.09.15 L 155
Canalina per contenitore con cassetiera L 40 / Wardrobe with drawer 40 D. wire management
910.AP.09.11 L 116,5
Canalina per contenitore con cassetiera L 80 / Wardrobe with drawer 80 D. wire management

L 90 P 60 x H 2

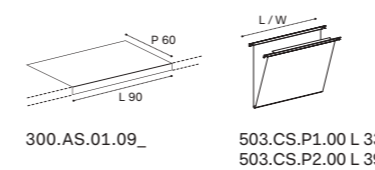

300.AS.01.09_
503.CS.P1.00 L 33
503.CS.P2.00 L 39

Bracci porta video / Arms for video support

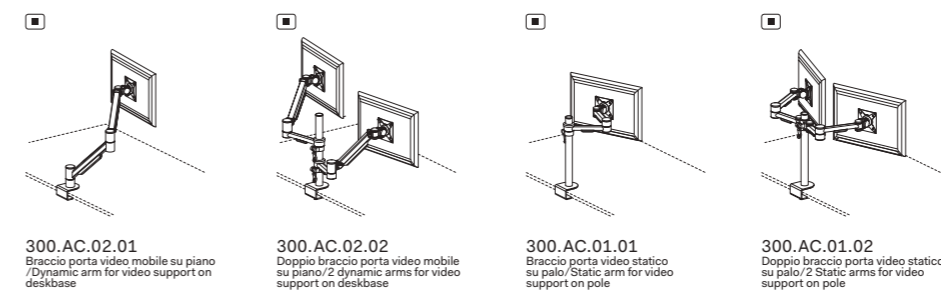

300.AC.02.01 Braccio porta video mobile su piano / Dynamic arm for video support on deskbase
300.AC.02.02 Doppio braccio porta video mobile su piano / 2 dynamic arms for video support on deskbase
300.AC.01.01 Braccio porta video statico su palo / Static arm for video support on pole
300.AC.01.02 Doppio braccio porta video statico su palo / 2 Static arms for video support on pole

Note:

- 1 Le finiture in melaminico effetto pelle non sono in pronta consegna. Per la disponibilità contattare l'ufficio commerciale. / The melamine leather-effect finishes are not in prompt delivery. Please contact the commercial department to check availability;
- 2 Le dimensioni sono espresse in cm - consultare il listino prezzi per le caratteristiche tecniche, i codici degli articoli e delle finiture. / Dimensions are stated in cm - for technical characteristics, article code numbers and finishing see price list;
- 3 Per la scelta dei contenitori e degli accessori vari, consultare il relativo listino o catalogo. / To choose storage units and accessories, please check correspondent price list or catalogue;
- 4 Prodotti non in pronta consegna. Per la disponibilità contattare l'ufficio commerciale. / Items not in prompt delivery. Please contact the commercial department to check availability;
- 5 Articoli prodotti solo su richiesta. / Items produced only on demand;

Workstations

“Le collezioni dedicate all’operatività.”
Una vasta gamma di prodotti e soluzioni che si adattano perfettamente ad ogni esigenza: eleganza e minimalismo, leggerezza costruttiva, design, funzionalità, tecnologia e semplicità.

“The collections for workstations.” A wide range of products and solutions for any need: elegance and minimalism, lightweight construction, design and functionality, technology and simplicity.

E-Place P. 188



Entity P. 208



DV802 P. 232



Nobu P. 254



Treko P. 274



Enna P. 292



Nida P. 316



E-Place

DV804

Versatile, giovane e funzionale. Sistema con grandissima facilità di installazione. Un prodotto destinato a comporre spazi d'arredo operativi e direzionali completi, al passo con l'evoluzione del lavoro.

Versatile, fresh styled and functional, a range with an extremely easy assembly system. This series fully furnishes operative and executive spaces, in line with today's work evolutions.

















Tavoli / Tables

Piani di lavoro sp. 2.5 cm, in melaminico con bordi perimetrali in ABS sp. 0.2 cm / Worktops 2.5 cm thick, in melamine with 0.2 cm ABS edge-profiles
Modesty panel sp. 1.8 cm, in melaminico/Modesty panel 1.8 cm thick, in melamine



Strutture metalliche / Metal structures



Mobili di servizio / Service units

Scocca e ripiani sp. 1.8 cm, in melaminico / Bodies and shelves 1.8 cm thick, in melamine



Ante scorrevoli sp. 1.8 cm, in melaminico con bordo ABS sp. 0.15 cm colore alluminio / Sliding doors 1.8 cm thick, in melamine with aluminium-coloured ABS edge-profiles 0.15 cm thick

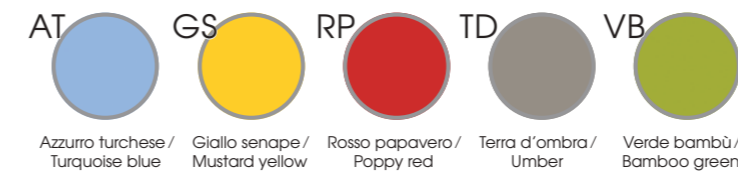

Ante scorrevoli sp. 1.8 cm, in melaminico con bordo ABS sp. 0.15 cm in tinta / Sliding doors 1.8 cm thick, in melamine with ABS edge-profiles 0.15 cm thick, in same color

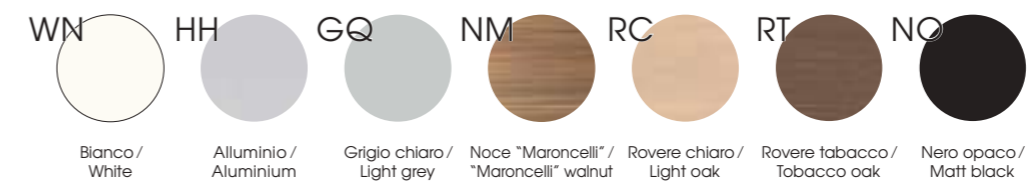





Note

Per i colori e le finiture dei Frontal Panels, vedere il relativo capitolo in DV300 - Accessori. / For colours and finishes of Frontal Panels, see the chapter in DV300 - Accessories.
☐ Prodotti non in pronta consegna. Per la disponibilità contattare l'ufficio commerciale. / Items not in prompt delivery. Please contact the commercial department to check availability.

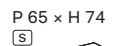
Piani di lavoro in melaminico sp. 25 mm con bordi perimetrali in ABS sp. 2 mm / Worktops in melamine 1" thick with perimetrical edges in ABS 2/32" thick



Tavoli scrivanie/Desks

 P 65 x H 74 S	 P 65 x H 74 S	 P 80 x H 74 S	 P 80 x H 74 S
804.TS.01.08_L 80 804.TS.01.10_L 100 804.TS.01.14_L 140 804.TS.01.16_L 160 804.TS.01.18_L 180	804.TS.05.08_L 80 804.TS.05.10_L 100 804.TS.05.14_L 140 804.TS.05.16_L 160 804.TS.05.18_L 180	804.TS.02.14_L 140 804.TS.02.16_L 160 804.TS.02.18_L 180 804.TS.02.20_L 200	804.TS.06.14_L 140 804.TS.06.16_L 160 804.TS.06.18_L 180 804.TS.06.20_L 200

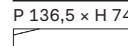

Allunghi laterali e su cassettiere portanti / Lateral extensions and extensions on carrying pedestals

 P 65 x H 74
S
804.TD.01.08_L 80
804.TD.01.10_L 100

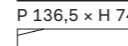

Tavoli P 136,5 a 2 scrivanie contrapposte/Benches 136,5 depth

 P 136,5 x H 74 A	 P 136,5 x H 74 S	 P 136,5 x H 74 S
804.TB.51.14_L 140 804.TB.51.16_L 160	804.TB.61.14_L 140 804.TB.61.16_L 160	

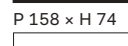

Tavoli a 2 scrivanie contrapposte p 136,5 + binario centrale / Benches 136,5 depth + central rail

 P 136,5 x H 74 B	 P 136,5 x H 74 S	 P 136,5 x H 74 S
804.TB.53.14_L 140 804.TB.53.16_L 160	804.TB.63.14_L 140 804.TB.63.16_L 160	



Tavoli P 158 a 2 scrivanie contrapposte + binario centrale con 2 sportelli/Benches 158 depth + central rail with 2 flip-up covers

 P 158 x H 74 B	 P 158 x H 74 S	 P 158 x H 74 S
804.TB.73.14_L 140 804.TB.73.16_L 160	804.TB.77.14_L 140 804.TB.77.16_L 160	





Tavoli P 166,5 a 2 scrivanie contrapposte/Benches 166,5 depth

 P 166,5 x H 74 A	 P 166,5 x H 74 S	 P 166,5 x H 74 S
804.TB.56.14_L 140 804.TB.56.16_L 160	804.TB.66.14_L 140 804.TB.66.16_L 160	



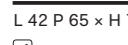

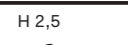
Tavoli a 2 scrivanie contrapposte p 166,5 + binario centrale / Benches 166,5 depth + central rail

 P 166,5 x H 74 B	 P 166,5 x H 74 S	 P 166,5 x H 74 S
804.TB.58.14_L 140 804.TB.58.16_L 160	804.TB.68.14_L 140 804.TB.68.16_L 160	

Cassettiere portanti/Carrying pedestals

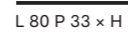
 L 42 P 65 x H 71,5 m	 H 2,5 550.CG.14.04_Top	 H 1,8 550.CG.12.04_Zoccolo (Optional) / Base frame (Optional)	
550.CS.30.04_	550.CS.40.04_		

Contenitori H 74/Storage units H 74

 L 80 P 33 x H 71,5 m	 H 2,5 550.CG.14.08_Top	 H 1,8 550.CG.12.08_Zoccolo (Optional) / Base frame (Optional)	
550.CG.01.08_ A giorno/Open	550.CC.02.08_ Con ante/With doors		

Raccordi/Connection elements

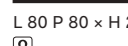
 L 80 P 80 x H 2,5
A
804.RA.01.08_





Piani terminali/Terminal tops

 P 40 x H 2,5
A **B**
804.PT.01.13_L 136,5
804.PT.01.15_L 158
804.PT.01.16_L 166,5

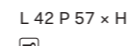

- Note:
- 1** Le dimensioni sono espresse in cm - consultare il listino prezzi per le caratteristiche tecniche, i codici degli articoli e delle finiture / Dimensions are stated in cm - for technical characteristics, article code numbers and finishing see price list;
 - m** Con serratura/With lock.
 - A** Da utilizzare solo con tavoli indipendenti / To be used with single desks
 - B** Fino ad esaurimento/Until exhaustion;
 - A** Senza binario/Without rail;
 - S** Con piani con angoli a spigolo/With tops with sharp corners;
 - B** Con binario centrale/With central rail;

Piani di lavoro in melaminico sp. 25 mm con bordi perimetrali in ABS sp. 2 mm / Worktops in melamine 1" thick with perimetrical edges in ABS 2/32" thick

Cassettiere/Pedestals

 L 42 P 57 x H 55,5 m	 L 32,2 P 54,2 x H 55,5 m	 L 42,2 P 54,2 x H 55,5 m	 L 42,2 P 54,2 x H 55,5 m
550.CS.10.04_ Melaminico/Melamine	550.CS.20.04_ Melaminico/Melamine	550.CS.1M.03_ Metalliche/Metallic	550.CS.2M.03_ Metalliche/Metallic
		550.CS.1M.04_ Metalliche - Vaschetta porta cancelleria inclusa/Metallic - Stationery tray included	550.CS.2M.04_ Metalliche - Vaschetta porta cancelleria inclusa/Metallic - Stationery tray included

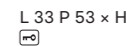

Cassettiere sospese/Hanged pedestals

 L 33 P 53 x H 35 m	 L 32,5 P 52 x H 7 m
804.CS.11.03 Sospesa melaminico / Hanged melamine	804.CA.01.05 Sospesa metallica / Hanged metallic

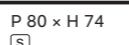
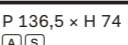
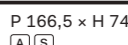

Note: Per portacancelleria cassetti, vedi capitolo DV300-Accessori/For stationary tray, see chapter DV300-Accessories

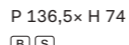
Tavoli integrabili su mobili di servizio/Integrable desks for service units

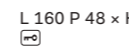
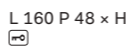

 P 65 x H 74 S	 P 80 x H 74 S	 P 136,5 x H 74 A S	 P 166,5 x H 74 A S
804.TI.01.14_L 140 804.TI.01.16_L 160 804.TI.01.18_L 180	804.TI.02.14_L 140 804.TI.02.16_L 160 804.TI.02.18_L 180	804.TI.54.14_L 140 804.TI.54.16_L 160	804.TI.55.14_L 140 804.TI.55.16_L 160

 P 158 x H 74 B S	 P 136,5 x H 74 B S	 P 166,5 x H 74 B S
804.TI.56.14_L 140 804.TI.56.16_L 160	804.TI.57.14_L 140 804.TI.57.16_L 160	804.TI.58.14_L 140 804.TI.58.16_L 160



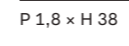

Mobili di servizio/Service units

 L 160 P 48 x H 58 m	 L 160 P 48 x H 58 m	
804.MS.02.16_ Monofacciale/Uniface	804.MS.01.16_ Bifacciale/Bifacial	Optional per cod. 804.CA.01.03 / Optional for code 804.MS.02.16_ / 804.MS.01.16_

Modesty panels

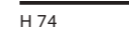
 P 1,8 x H 38 Dx/R	 P 1,8 x H 38 Sx/L
804.MP.02.11_L 110 804.MP.02.14_L 140	804.MP.03.11_L 110 804.MP.03.14_L 140

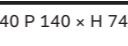
Tavoli riunione/Meeting tables

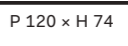
 H 74	 H 74	 L 140 P 140 x H 74	 P 120 x H 74	 P 120 x H 74
804.TR.11.10_ Ø 100 804.TR.11.12_ Ø 120	804.TR.21.10_ Ø 100 804.TR.21.12_ Ø 120	804.TR.32.14_ R	804.TR.32.24_L 240 R 804.TR.32.30_L 300 R	804.TR.03.24_L 240 R 804.TR.03.30_L 300 R

- Note:
- 1** Le dimensioni sono espresse in cm - consultare il listino prezzi per le caratteristiche tecniche, i codici degli articoli e delle finiture / Dimensions are stated in cm - for technical characteristics, article code numbers and finishing see price list;
 - m** Con serratura/With lock.
 - R** Prodotti non in pronta consegna. Per la disponibilità contattare l'ufficio commerciale / Items not in prompt delivery. Please contact the commercial department to check availability;
 - S** Con piani con angoli a spigolo/With tops with sharp corners;
 - R** Con piani con angoli raggiati/With tops with rounded corners;
 - A** Senza binario/Without rail;
 - B** Con binario centrale/With central rail;

Morsetti e supporti in per frontal panels Sp. 0,5 - 0,8 - 1 - 3 / Clamps for frontal panels T. 0,5 - 0,8 - 1 - 3

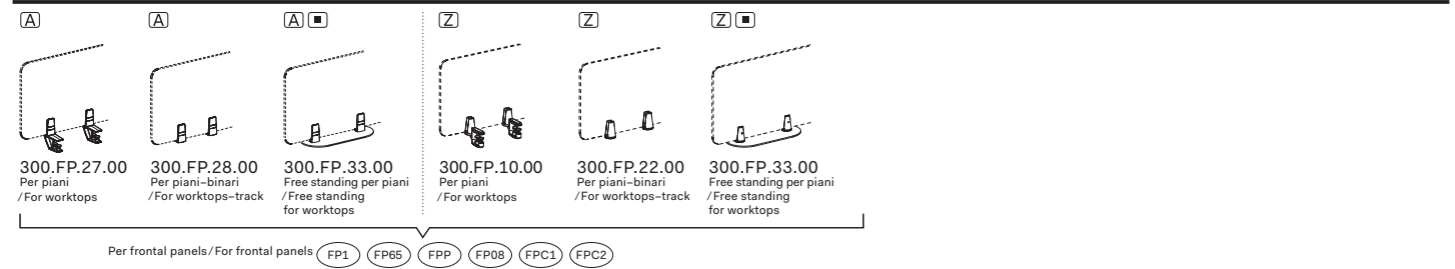

Frontal panels Sp. 0,8 - 1	Frontal panel fonoassorbenti Sp. 3 / Acoustic frontals panels T. 3	Frontal panels H 65
<p>P 1 x H 39</p> <p>FP1</p> <p>300.FP.06.06_L 64 300.FP.06.07_L 79 300.FP.06.09_L 99 300.FP.06.11_L 119 300.FP.06.13_L 139 300.FP.06.15_L 159 300.FP.06.17_L 179 300.FP.06.19_L 199 Melaminico/Melamine</p> <p>P 0,8 x H 39</p> <p>FP08</p> <p>300.FPV1.06_L 64 300.FPV1.07_L 79 300.FPV1.09_L 99 300.FPV1.11_L 119 300.FPV1.13_L 139 300.FPV1.15_L 159 300.FPV1.17_L 179 300.FPV1.19_L 199 Vetro/Glass</p>	<p>P 3 x H 39</p> <p>FPC1</p> <p>300.FP.40.06_L 64 300.FP.40.07_L 79 300.FP.40.09_L 99 300.FP.40.11_L 119 300.FP.40.13_L 139 300.FP.40.15_L 159 300.FP.40.17_L 179 Tessuto/Fabric</p> <p>P 3 x H 59</p> <p>FPC2</p> <p>300.FP.50.13_L 139 300.FP.50.15_L 159 Tessuto/Fabric</p>	<p>P 1 x H 65</p> <p>FP65</p> <p>300.FP.09.06_L 64 300.FP.09.07_L 79 300.FP.09.09_L 99 300.FP.09.11_L 119 300.FP.09.13_L 139 300.FP.09.15_L 159 300.FP.09.17_L 179 300.FP.09.19_L 199 Melaminico/Melamine</p> <p>P 0,5 x H 65</p> <p>FPP</p> <p>300.FP.69.06 L 64 300.FP.69.11 L 119 300.FP.69.13 L 139 300.FP.69.15 L 159 Plexiglass</p>

N.B.: Per i frontal con lunghezza maggiore o uguale ai 139 cm, ordinare 2 kit di supporti per frontal panel / Note: For frontal panels with a length greater than or equal to 139 cm, order 2 kits of clamps-supports for frontal panels

Frontal panels con morsetti e supporti integrati / Frontal panels with clamps and conic clamps	Frontal panels H 65 con supporto freestanding integrato / Frontal panels with freestanding bracket integrated
<p>L 77 P 1 x H 39</p> <p>FR19.07</p> <p>300.FR.19.07_ Per piani melaminico / For worktops melamine</p> <p>L 77 P 1 x H 39</p> <p>FR19.07</p> <p>300.FR.19.07_ Per piani melaminico / For worktops melamine</p>	<p>L 77 P 18 x H 65</p> <p>FR20.07</p> <p>300.FR.20.07_ Melaminico / Melamine</p> <p>L 77 P 18 x H 65</p> <p>FR20.07</p> <p>300.FR.20.07_ Melaminico / Melamine</p> <p>L 77 P 18 x H 65</p> <p>FR21.07</p> <p>300.FR.21.07 Plexiglass</p> <p>L 77 P 18 x H 65</p> <p>FR21.07</p> <p>300.FR.21.07 Plexiglass</p>

Accessori per frontal panels in melaminico / Accessories for melamine frontal panels

L 6,5 P 6,5 x H 8,5	L 50 P 17 x H 3	L 31 P 22 x H 5	L 23 P 10 x H 29	L 35 P 6,5 x H 30
FA01.01	FA02.05	FA04.03	FA06.02	FA08.03

Note: Il posizionamento degli accessori sui frontal panel in vetro prevede l'utilizzo di una guarnizione in PVC trasparente (Optional su richiesta) / Placement of accessories on glass front panel need the use of a trasparent PVC gasket (Optional on request)
 Non utilizzabile su frontal panels in plexiglass e frontal panels in tessuto fonoassorbente / Not usable for plexiglass frontal panels and acoustic frontal panels

Accessori su binari / Accessories on rail	Accessori / Accessories
<p>804.AB.01.00 Supporti per lampade / Lamp supports</p>	<p>300.AC.16.02</p> <p>300.AC.06.05</p> <p>804.AC.02.02 P 65</p> <p>804.AC.03.02 P 80 - 100 - 158 - 166,5</p> <p>804.AC.02.13 P 136,5</p>

Note:

1 Le dimensioni sono espresse in cm - consultare il listino prezzi per le caratteristiche tecniche, i codici degli articoli e delle finiture / Dimensions are stated in cm - for technical characteristics, article code numbers and finishing see price list;

2 Prodotti non in pronta consegna. Per la disponibilità contattare l'ufficio commerciale / Items not in prompt delivery. Please contact the commercial department to check availability;

A Morsetti o supporti in ABS / ABS clamps

Z Morsetti o supporti in ZAMA / Zamak clamps

V Vetro / Glass.

P Plexiglass

Canalizzazione - Elettrificazione - Accessori / Wire management - Electrification - Accessories

<p>804.AC.08.06_</p> <p>300.AC.26.02 L 24,5 300.AC.26.03 L 34,5 300.AC.26.04 L 44,5</p> <p>300.AC.20.02_L 24,5 300.AC.20.03_L 34,5 300.AC.20.04_L 44,5</p> <p>300.AC.25.02 L 23,5 300.AC.25.03 L 33,5 300.AC.25.04 L 43,5 Marsupio/Basket</p> <p>300.AC.38.02_H 2,4</p> <p>300.AC.67.03 Marsupio per top access / Basket for top access 300.AC.38.02</p>	<p>300.AP.08.06_</p> <p>300.AV.1.00</p> <p>300.AP.F1.00</p> <p>300.AP.T2.01 Ø 8</p> <p>300.AP.T7.01 Ø 6</p> <p>300.AP.T8.01 Ø 8</p> <p>804.CL.02.01 L 10</p> <p>804.CL.02.04 L 45</p> <p>804.CL.02.06 L 65</p> <p>804.CL.02.08 L 85</p> <p>804.CL.02.11 L 110</p> <p>804.AP.01.14 L 140</p> <p>804.AP.01.16 L 160</p> <p>804.AP.02.14 L 140</p> <p>804.AP.02.16 L 160</p> <p>804.AP.03.01</p> <p>804.AP.04.01</p>	<p>300.AC.26.02 L 24,5 300.AC.26.03 L 34,5 300.AC.26.04 L 44,5</p> <p>300.AC.20.02_L 24,5 300.AC.20.03_L 34,5 300.AC.20.04_L 44,5</p> <p>300.AC.25.02 L 23,5 300.AC.25.03 L 33,5 300.AC.25.04 L 43,5 Marsupio/Basket</p> <p>300.AC.38.02_H 2,4</p> <p>300.AC.67.03 Marsupio per top access / Basket for top access 300.AC.38.02</p> <p>300.AC.26.02 L 24,5 300.AC.26.03 L 34,5 300.AC.26.04 L 44,5</p> <p>300.AC.20.02_L 24,5 300.AC.20.03_L 34,5 300.AC.20.04_L 44,5</p> <p>300.AC.25.02 L 23,5 300.AC.25.03 L 33,5 300.AC.25.04 L 43,5 Marsupio/Basket</p> <p>300.AC.38.02_H 2,4</p> <p>300.AC.67.03 Marsupio per top access / Basket for top access 300.AC.38.02</p>	<p>300.AP.S1.02 L 20,5 300.AP.S1.03 L 30 300.AP.S1.04 L 42 Per / For top access 300.AC.26_</p> <p>300.AC.38.02_H 2,4</p> <p>300.AC.67.03 Marsupio per top access / Basket for top access 300.AC.38.02</p> <p>300.AC.26.02 L 24,5 300.AC.26.03 L 34,5 300.AC.26.04 L 44,5</p> <p>300.AC.20.02_L 24,5 300.AC.20.03_L 34,5 300.AC.20.04_L 44,5</p> <p>300.AC.25.02 L 23,5 300.AC.25.03 L 33,5 300.AC.25.04 L 43,5 Marsupio/Basket</p> <p>300.AC.38.02_H 2,4</p> <p>300.AC.67.03 Marsupio per top access / Basket for top access 300.AC.38.02</p>	<p>300.AC.26.02 L 24,5 300.AC.26.03 L 34,5 300.AC.26.04 L 44,5</p> <p>300.AC.20.02_L 24,5 300.AC.20.03_L 34,5 300.AC.20.04_L 44,5</p> <p>300.AC.25.02 L 23,5 300.AC.25.03 L 33,5 300.AC.25.04 L 43,5 Marsupio/Basket</p> <p>300.AC.38.02_H 2,4</p> <p>300.AC.67.03 Marsupio per top access / Basket for top access 300.AC.38.02</p>	<p>300.AC.26.02 L 24,5 300.AC.26.03 L 34,5 300.AC.26.04 L 44,5</p> <p>300.AC.20.02_L 24,5 300.AC.20.03_L 34,5 300.AC.20.04_L 44,5</p> <p>300.AC.25.02 L 23,5 300.AC.25.03 L 33,5 300.AC.25.04 L 43,5 Marsupio/Basket</p> <p>300.AC.38.02_H 2,4</p> <p>300.AC.67.03 Marsupio per top access / Basket for top access 300.AC.38.02</p>	<p>300.AC.26.02 L 24,5 300.AC.26.03 L 34,5 300.AC.26.04 L 44,5</p> <p>300.AC.20.02_L 24,5 300.AC.20.03_L 34,5 300.AC.20.04_L 44,5</p> <p>300.AC.25.02 L 23,5 300.AC.25.03 L 33,5 300.AC.25.04 L 43,5 Marsupio/Basket</p> <p>300.AC.38.02_H 2,4</p> <p>300.AC.67.03 Marsupio per top access / Basket for top access 300.AC.38.02</p>
--	---	---	---	---	---	---

300.APT4.01
300.APT5.01 - UK
300.APT6.01 - US

300.AP.T8.11
300.AP.T8.14
300.AP.T8.17
300.AP.T8.20

300.AB.08.04 Mensolina / Shelf

300.FA.09.01 Portapenna / Pen holder

Bracci porta video / Arms for video support

<p>300.AC.02.01 Braccio porta video mobile su piano / Dynamic arm for video support on deskbase</p>	<p>300.AC.02.02 Doppio braccio porta video mobile su piano / 2 dynamic arms for video support on deskbase</p>	<p>300.AC.01.01 Braccio porta video statico su palo / Static arm for video support on pole</p>	<p>300.AC.01.02 Doppio braccio porta video statico su palo / 2 static arms for video support on pole</p>
---	---	--	--

Note:

1 Le dimensioni sono espresse in cm - consultare il listino prezzi per le caratteristiche tecniche, i codici degli articoli e delle finiture / Dimensions are stated in cm - for technical characteristics, article code numbers and finishing see price list;

2 Per la scelta dei contenitori e degli accessori vari, consultare il relativo listino o catalogo / To choose storage units and accessories, please check correspondent price list or catalogue;

Articoli prodotti solo su richiesta / Items produced only on demand;

Fino ad esaurimento / Until exhaustion;

Prodotti non in pronta consegna. Per la disponibilità contattare l'ufficio commerciale / Items not in prompt delivery. Please contact the commercial department to check availability;

Entity

DV801

Linea operativa che si distingue per la sua particolare essenzialità e semplicità. Attuale nei concetti fondamentali del lavoro in ufficio la collezione di scrivanie è estremamente funzionale nelle postazioni di lavoro condivise.

This workstation range steps out for its essentiality and simplicity. Responds to the fundamental concepts required in a work environment, extremely functional in shared workstation solutions.









Semplici concetti:
elementi aggregabili
creano composizioni
base di forte rigore
funzionale riducendo
i componenti,
semplificando le forme
e la logica compositiva.

*Simple concepts:
combinable elements
create compositions
based on strong
functionality by reducing
components, simplifying
form and using
compositional logic.*





Gli essenziali frontal panel in vetro fumè si abbinano con estrema eleganza ai piani di lavoro.



The smoked glass frontal panels create an extremely elegant combination with the worktops.







Tavoli / Tables

Piani di lavoro sp. 1.8 cm, in melaminico con bordi in ABS sp. 0.2 cm / Worktops 1.8 cm thick, in melamine with ABS edge-profiles 0.2 cm thick



Piani di lavoro sp. 1 cm, in vetro temprato retrolaccato acidato con bordi perimetrali lavorati a filo lucido / Worktops 1 cm thick, rear-lacquered and acetated tempered glass with outer polished edges



Strutture metalliche / Metal structures



Modesty panel

Modesty panel sp. 1.8 cm, in melaminico / Modesty panel 1.8 cm thick, in melamine



Mobili di servizio / Service units

Scocca e ripiani sp. 1.8 cm, in melaminico / Bodies and shelves 1.8 cm thick, in melamine



Ante scorrevoli sp. 1.8 cm, in melaminico con bordo ABS sp. 0.15 cm colore alluminio / Sliding doors 1.8 cm thick, in melamine with aluminium-coloured ABS edge-profiles 0.15 cm thick

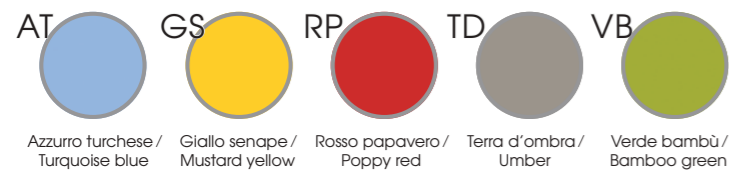

Ante scorrevoli sp. 1.8 cm, in melaminico con bordo ABS sp. 0.15 cm in tinta / Sliding doors 1.8 cm thick, in melamine with ABS edge-profiles 0.15 cm thick, in same color

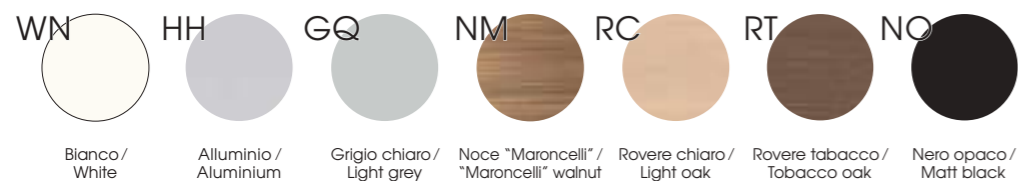

Note

Per i colori e le finiture dei Frontal Panels, vedere il relativo capitolo in DV300 - Accessori. / For colours and finishes of Frontal Panels, see the chapter in DV300 - Accessories.
 [] Prodotti non in pronta consegna. Per la disponibilità contattare l'ufficio commerciale. / Items not in prompt delivery. Please contact the commercial department to check availability.

Piani di lavoro in melaminico sp. 18 mm con bordi perimetrali in ABS / Worktops in melamine 23/32" thick with perimetrical edges in ABS

Tavoli scrivania P 65 / Desks 65 depth

P 65 x H 74

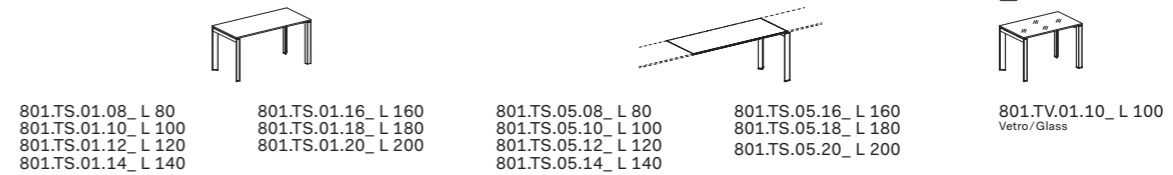

Tavoli scrivania P 80 / Desks 80 depth

P 80 x H 74

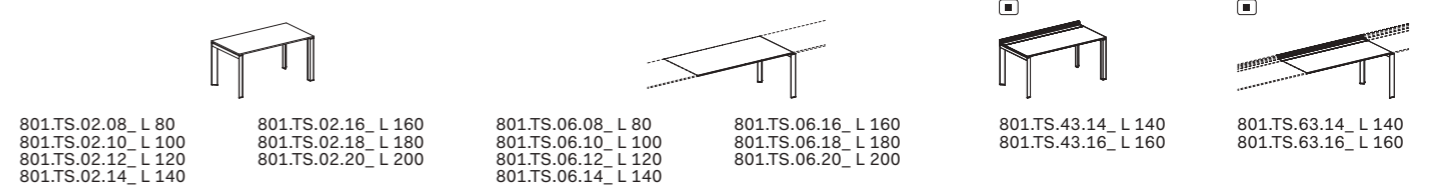

Tavoli executive P 90 / 90 depth executive tables

P 90 x H 74

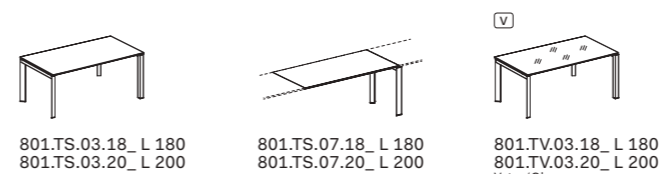

Allunghi laterali / Lateral extensions

P 65 x H 74, P 80 x H 74, P 65 x H 74, P 65 x H 1,8

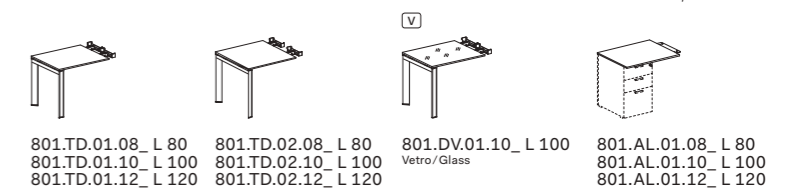

Tavoli scrivania P 136,5 / Desks 136,5 depth

P 136,5 x H 74

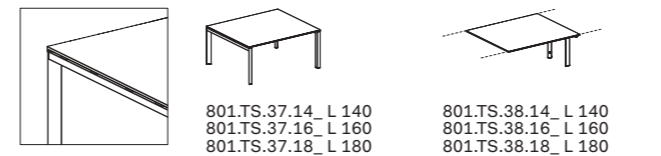

Tavoli P 136,5 a 2 scrivanie contrapposte / Benches 136,5 depth

P 136,5 x H 74

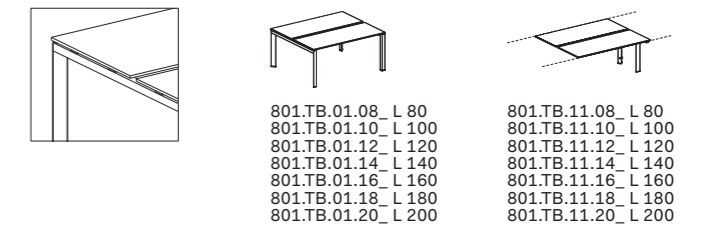

Tavoli P 136,5 a 2 scrivanie contrapposte + binario centrale / Benches 136,5 depth + central rail

P 136,5 x H 74

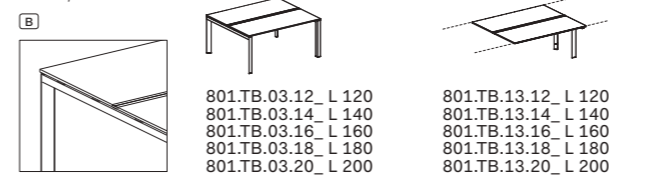

Tavoli P 158 a 2 scrivanie contrapposte con profilo doppio attrezzabile / Benches 158 depth with double accessory profile

P 158 x H 74

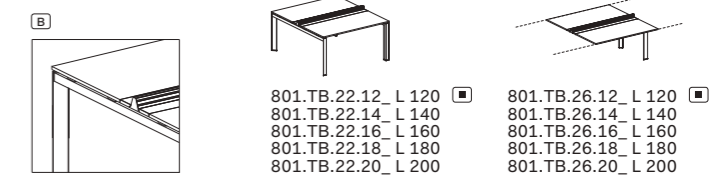

Tavoli P 158 a 2 scrivanie contrapposte + binario centrale con 2 sportelli / Benches 158 depth + central rail with 2 flip-up covers

P 158 x H 74

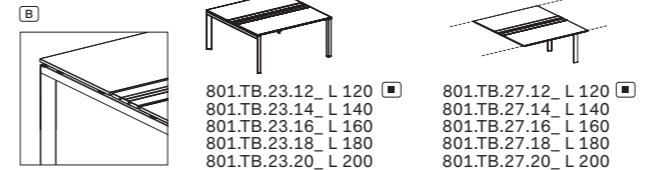

Tavoli scrivania doppia P 158 con asole e 2 top access / Benches 158 depth with opening and 2 top access

P 158 x H 74

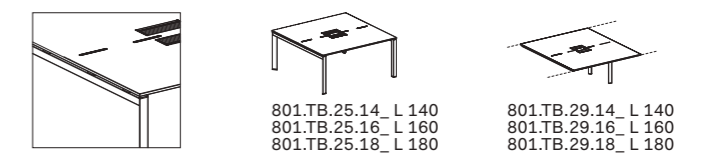

Note:

[] Le dimensioni sono espresse in cm - consultare il listino prezzi per le caratteristiche tecniche, i codici degli articoli e delle finiture / Dimensions are stated in cm - for technical characteristics, article code numbers and finishing see price list;

[] Prodotti non in pronta consegna. Per la disponibilità contattare l'ufficio commerciale / Items not in prompt delivery. Please contact the commercial department to check availability;

[V] Vetro / Glass.

[B] Con binario centrale / With central rail;

Piani di lavoro in melaminico sp. 18 mm con bordi perimetrali in ABS/Worktops in melamine 23/32" thick with perimetrical edges in ABS

Tavoli P 166,5 a 2 scrivanie contrapposte/Benches 166,5 depth

P 166,5 x H 74

801.TB.06.08_L 80
801.TB.06.10_L 100
801.TB.06.12_L 120
801.TB.06.14_L 140
801.TB.06.16_L 160
801.TB.06.18_L 180
801.TB.06.20_L 200

Tavoli P 166,5 a 2 scrivanie contrapposte + binario centrale /Benches 166,5 depth + central rail

P 166,5 x H 74

801.TB.08.12_L 120
801.TB.08.14_L 140
801.TB.08.16_L 160
801.TB.08.18_L 180
801.TB.08.20_L 200

801.TB.18.12_L 120
801.TB.18.14_L 140
801.TB.18.16_L 160
801.TB.18.18_L 180
801.TB.18.20_L 200

Tavolo riunioni/Conference tables

P 120 x H 74

801.TR.40.24_L 240

Componenti per tavoli/Components for desks

P 65 x H 1,8 P 80 x H 1,8

801.PD.01.08_L 80
801.PD.01.10_L 100
801.PD.01.12_L 120

801.PD.02.08_L 80
801.PD.02.10_L 100
801.PD.02.12_L 120

Piani terminali/Terminal tops

P 40 x H 1,8 P 65 x H 74

801.PT.01.13_L 136,5
801.PT.01.15_L 158
801.PT.01.16_L 166,5

801.PT.02.13_L 136,5
801.PT.02.15_L 158
801.PT.02.16_L 166,5

Cassettiere portanti/Carrying pedestals

L 42 P 65 x H 71,5

550.CS.30.04_ 550.CS.40.04_

H 1,8
550.CG.13.04_ Top

H 2,5
550.CG.11.04 Zoccolo (Optional) /Base frame (Optional)

801.CG.07.00

Contenitori H 74/Storage units H 74

L 80 P 33 x 71,5

550.CG.01.08_ A giorno/Open

550.CC.02.08_ Con ante/With doors

H 1,8
550.CG.13.08_ Top

H 2,5
550.CG.11.08 Zoccolo (Optional) /Base frame (Optional)

Tavoli integrabili su mobili di servizio/Integrable desks for service units

P 65 x H 74 P 80 x H 74 P 90 x H 74 P 136,5 x H 74

801.TI.01.16_L 160
801.TI.01.18_L 180
801.TI.01.20_L 200

801.TI.02.16_L 160
801.TI.02.18_L 180
801.TI.02.20_L 200

801.TI.03.18_L 180
801.TI.03.20_L 200

801.TI.04.14_L 140
801.TI.04.16_L 160
801.TI.04.18_L 180

801.TI.05.16_L 160
801.TI.05.18_L 180
801.TI.05.20_L 200

801.TI.06.16_L 160
801.TI.06.18_L 180
801.TI.06.20_L 200

P 158 x H 74

801.TI.13.16_L 160
801.TI.13.18_L 180
801.TI.13.20_L 200

801.TI.07.14_L 140
801.TI.07.16_L 160
801.TI.07.18_L 180

801.TI.08.16_L 160
801.TI.08.18_L 180
801.TI.08.20_L 200

P 166,5 x H 74

801.TI.10.16_L 160
801.TI.10.18_L 180
801.TI.10.20_L 200

801.TI.11.16_L 160
801.TI.11.18_L 180
801.TI.11.20_L 200

Mobili di servizio con ante scorrevoli/Service units with sliding doors

L 160 P 48 x H 58

801.MS.02.16_ Monofacciale/Uniface

L 160 P 48 x H 58

801.MS.01.16_ Bifacciale/Bifacial

Optional 801.CA.01.03

Optional 503.CS.P1.00

Optional 503.CS.A5.04

Optional per cod. 801.MS.02.16_ /801.MS.01.16_ /Optional for code 801.MS.02.16_ /801.MS.01.16_

Note:

1 Le dimensioni sono espresse in cm - consultare il listino prezzi per le caratteristiche tecniche, i codici degli articoli e delle finiture/Dimensions are stated in cm - for technical characteristics, article code numbers and finishing see price list;

2 Prodotti non in pronta consegna. Per la disponibilità contattare l'ufficio commerciale/Items not in prompt delivery. Please contact the commercial department to check availability;

3 Con binario centrale/With central rail;

4 Con serratura/With lock;

Piani di lavoro in melaminico sp. 18 mm con bordi perimetrali in ABS/Worktops in melamine 23/32" thick with perimetrical edges in ABS

Cassettiere/Pedestals

L 42 P 57 x H 55,5

550.CS.10.04_ Melaminico/Melamine

550.CS.20.04_ Melaminico/Melamine

L 32,2 P 54,2 x H 55,5

550.CS.1M.03_ Metalliche/Metallic

550.CS.2M.03_ Metalliche/Metallic

L 42,2 P 54,2 x H 55,5

550.CS.1M.04_ Metalliche - Vaschetta porta cancelleria inclusa/Metallic - Stationery tray included

550.CS.2M.04_ Metalliche - Vaschetta porta cancelleria inclusa/Metallic - Stationery tray included

Cassettiere sospese /Hanged pedestals

L 33 P 53 x H 44

801.CS.11.03 Sospesa melaminico /Hanged melamine

L 32,5 P 52 x H 14,5

801.CA.01.05 Sospesa metallica /Hanged metallic

Note: Per portacancelleria cassetti, vedi capitolo DV300-Accessori/ For stationary tray, see chapter DV300-Accessories

Modesty panels

P 1,8 x H 35

801.MP.01.08_L 80
801.MP.01.10_L 100
801.MP.01.12_L 120
801.MP.01.14_L 140
801.MP.01.16_L 160
801.MP.01.18_L 180
801.MP.01.20_L 200 Per tavoli/For desks

P 5 x H 5,1

801.ST.01.65 L 35,5 [P] 65
801.ST.01.80 L 48,3 [P] 80
801.ST.01.90 L 58,3 [P] 90

Note: Staffa da aggiungere ai modesty panel per mobili di servizio in base alla profondità del piano di lavoro. Per l'integrazione consultare il relativo listino /Bracket to be added to the modesty panels for service units, depending on worktop's depth. Check the correspondent price list for the integration

Supporto per M.D.S. 2 Ante scorrevoli /Support for service unit 2 sliding doors

801.KT.01.06_L 65
801.KT.01.08_L 80
801.KT.01.09_L 90
801.KT.01.13_L 136,5
801.KT.01.15_L 158
801.KT.01.16_L 166,5

Gambe fisse terminali inclinate /Tilted fix terminal legs

P 5 x H 71

801.GF.01.06_L 65
801.GF.01.08_L 80
801.GF.01.09_L 90
801.GF.01.12_L 120
801.GF.01.13_L 136,5
801.GF.01.15_L 158
801.GF.01.16_L 166,5

P 5 x H 71

801.GF.02.06_L 65
801.GF.02.08_L 80
801.GF.02.09_L 90
801.GF.02.12_L 120
801.GF.02.13_L 136,5
801.GF.02.15_L 158
801.GF.02.16_L 166,5

Gambe fisse intermedie /Fix middle legs

P 5 x H 71

801.GF.03.06_L 65
801.GF.03.08_L 80
801.GF.03.09_L 90

801.GF.04.12_L 120
801.GF.04.13_L 136,5
801.GF.04.15_L 158
801.GF.04.16_L 166,5

801.GC.01.05_L 120-136,5
801.GC.01.07_L 158-166,5

Coppia carter per gambe intermedie/Pair of casings for middle legs

Gambe colonna fissa /Fix column leg

L 5 P 5 x H 72,2

801.GF.05.01_

Piani/Worktops

P 65 x H 1,8

801.PS.01.08_L 80
801.PS.01.10_L 100
801.PS.01.12_L 120
801.PS.01.14_L 140
801.PS.01.16_L 160
801.PS.01.18_L 180
801.PS.01.20_L 200

P 80 x H 1,8

801.PS.02.08_L 80
801.PS.02.10_L 100
801.PS.02.12_L 120
801.PS.02.14_L 140
801.PS.02.16_L 160
801.PS.02.18_L 180
801.PS.02.20_L 200

P 80 x H 1,8

801.PS.19.14_L 180
801.PS.19.16_L 200

P 90 x H 1,8

801.PS.03.18_L 180
801.PS.03.20_L 200

P 120 x H 1,8

801.PS.14.24_L 240

P 136,5 x H 1,8

801.PR.06.14_L 140
801.PR.06.16_L 160
801.PR.06.18_L 180

P 136,5 x H 1,8

801.PB.01.08_L 80
801.PB.01.10_L 100
801.PB.01.12_L 120
801.PB.01.14_L 140
801.PB.01.16_L 160
801.PB.01.18_L 180
801.PB.01.20_L 200

P 136,5 x H 1,8

801.PB.03.12_L 120
801.PB.03.14_L 140
801.PB.03.16_L 160
801.PB.03.18_L 180
801.PB.03.20_L 200

P 158 x H 1,8

801.PB.25.14_L 140
801.PB.25.16_L 160
801.PB.25.18_L 180

P 158 x H 1,8

801.PB.23.12_L 120
801.PB.23.14_L 140
801.PB.23.16_L 160
801.PB.23.18_L 180
801.PB.23.20_L 200

P 158 x H 1,8

801.PB.22.12_L 120
801.PB.22.14_L 140
801.PB.22.16_L 160
801.PB.22.18_L 180
801.PB.22.20_L 200

P 166,5 x H 1,8

801.PB.06.08_L 80
801.PB.06.10_L 100
801.PB.06.12_L 120
801.PB.06.14_L 140
801.PB.06.16_L 160
801.PB.06.18_L 180
801.PB.06.20_L 200

P 166,5 x H 1,8

801.PB.08.12_L 120
801.PB.08.14_L 140
801.PB.08.16_L 160
801.PB.08.18_L 180
801.PB.08.20_L 200

Note:

1 Le dimensioni sono espresse in cm - consultare il listino prezzi per le caratteristiche tecniche, i codici degli articoli e delle finiture/Dimensions are stated in cm - for technical characteristics, article code numbers and finishing see price list;

2 Prodotti non in pronta consegna. Per la disponibilità contattare l'ufficio commerciale/Items not in prompt delivery. Please contact the commercial department to check availability;

3 Con binario centrale/With central rail;

Morsetti e supporti in ABS per frontal panels Sp. 0,5 - 0,8 - 1 - 3 / ABS clamps for frontal panels T. 0,5 - 0,8 - 1 - 3

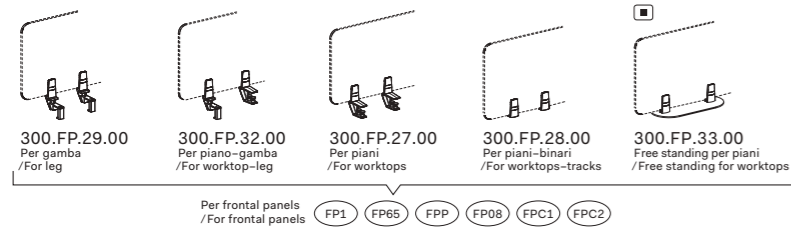

Morsetti e supporti in ZAMA per frontal panels Sp. 0,5 - 0,8 - 1 - 3 / Zamak clamps for frontal panels T. 0,5 - 0,8 - 1 - 3

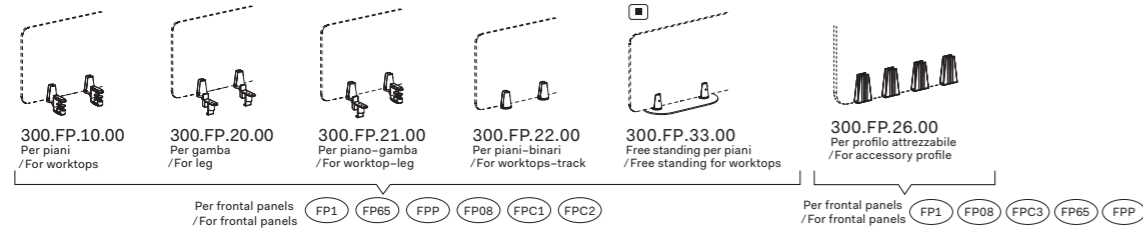

Frontal panels con morsetti e supporti integrati / Frontal panels with clamps and conic clamps

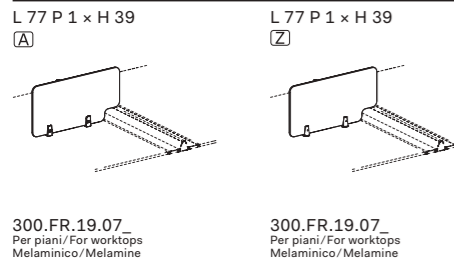

Fontal panels H 65 con supporto freestanding integrato / H 65 frontal panels with freestanding bracket integrated

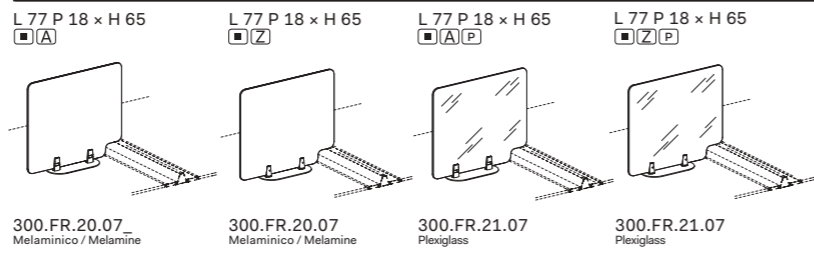

Frontal panels sp. 1 - sp. 0,8

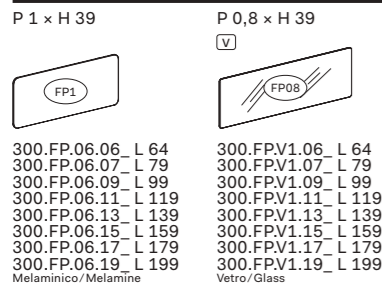

Frontal panel fonoassorbenti sp. 3 / Acoustic frontals panels t. 3

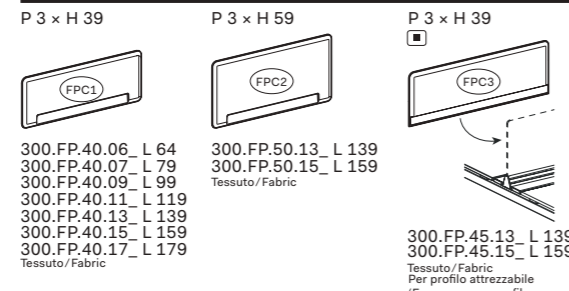

Fontal panels H 65

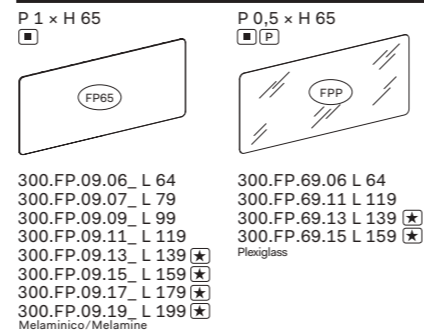

N.B.: Per i frontal con lunghezza maggiore o uguale ai 139 cm, ordinare 2 kit di supporti per frontal panel / Note: For frontal panels with a length greater than or equal to 139 cm, order 2 kits of clamps-supports for frontal panels

Accessori per frontal panels in melaminico / Accessories for melamine frontal panels

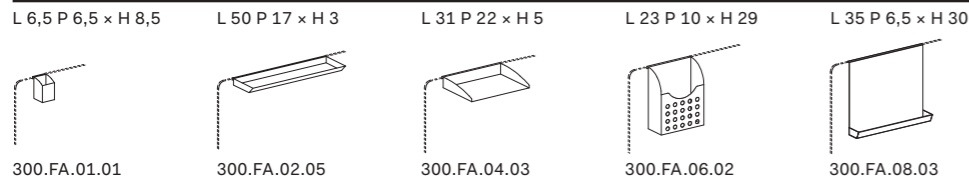

Il posizionamento degli accessori sui frontal panel in vetro prevede l'utilizzo di una guarnizione in PVC trasparente (Optional su richiesta) / Placement of accessories on glass front panel need the use of a transparent PVC gasket (Optional on request)
 Non utilizzabile su frontal panels in plexiglass e frontal panels in tessuto fonoassorbente / Not usable for plexiglass frontal panels and acoustic frontal panels

Note:

Le dimensioni sono espresse in cm - consultare il listino prezzi per le caratteristiche tecniche, i codici degli articoli e delle finiture / Dimensions are stated in cm - for technical characteristics, article code numbers and finishing see price list;

Prodotti non in pronta consegna. Per la disponibilità contattare l'ufficio commerciale / Items not in prompt delivery. Please contact the commercial department to check availability;

Morsetti o supporti in ABS / ABS clamps
 Morsetti o supporti in ZAMA / Zamak clamps
 Vetro / Glass.
 Plexiglass

Bracci porta video / Arms for video support

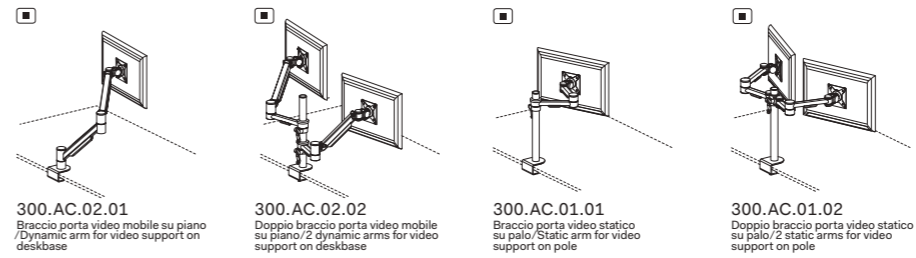

Canalizzazione - Elettrificazione - Accessori / Wire management - Electrification - Accessories

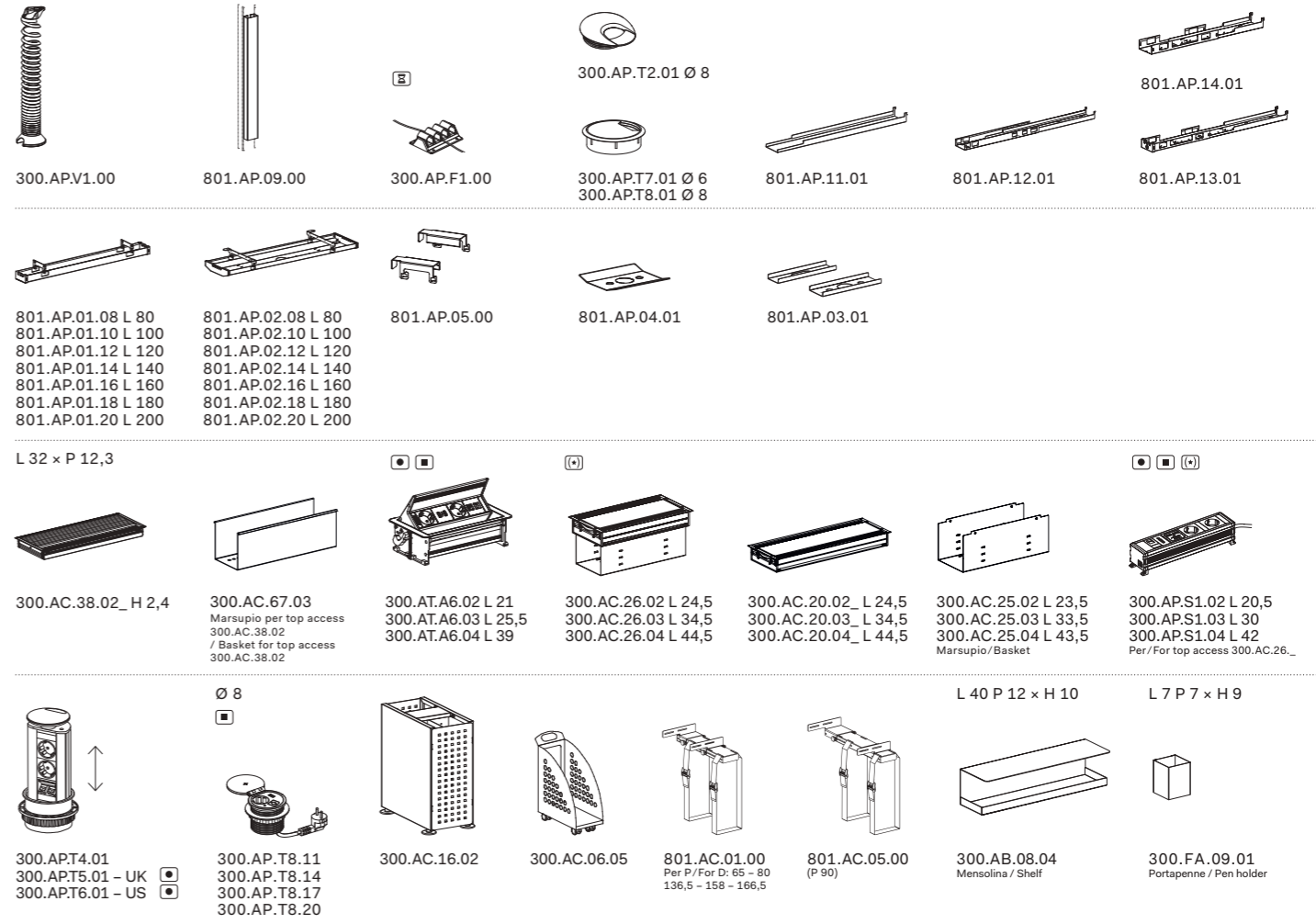

Accessori su binari / Accessories on rail

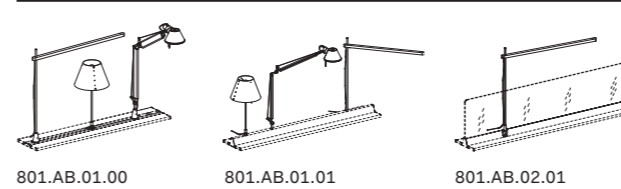

Porta dox / Top box

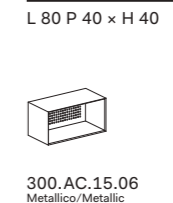

Note:

Le dimensioni sono espresse in cm - consultare il listino prezzi per le caratteristiche tecniche, i codici degli articoli e delle finiture / Dimensions are stated in cm - for technical characteristics, article code numbers and finishing see price list;
 Per la scelta dei contenitori e degli accessori vari, consultare il relativo listino o catalogo / To choose storage units and accessories, please check correspondent price list or catalogue;

Prodotti non in pronta consegna. Per la disponibilità contattare l'ufficio commerciale / Items not in prompt delivery. Please contact the commercial department to check availability;
 Articoli prodotti solo su richiesta / Items produced only on demand;

Fino ad esaurimento / Until exhaustion;

DV802

Ci sono collezioni di arredo che lasciano una traccia indelebile nell'evoluzione di un'azienda, questa fa suo il passato e la tradizione recuperando con artigiana passione il concept dei progetti vincenti.

There are collections that leave an indelible trace on the evolution of a company, they resume the past, the tradition recovering with passion concepts of winning projects.







Le gambe intermedie in metallo, vengono integrate con carter metallici per contenere e nascondere l'alloggio dei cablaggi, rendendole facilmente ispezionabili.

The middle legs in metal, are integrated with metal casings to contain and hide the cables, allowing also for easy inspection.











Il canale passacavi singolo, ispezionabile in lamiera, correde le scrivanie che sono abbinare ai contenitori integrati della serie Rio.

Accessible sheet metal single cable channel, accompanies the desks combined with the Rio integrated storage units.





Tavoli / Tables

Piani di lavoro sp. 1.8 cm, in melaminico con bordi in ABS sp. 0.2 cm / Worktops 1.8 cm thick, in melamine with ABS edge-profiles 0.2 cm thick



Piani di lavoro sp. 1 cm, in vetro temprato retrolaccato acidato con bordi perimetrali lavorati a filo lucido / Worktops 1 cm thick, rear-lacquered and acetated tempered glass with outer polished edges



Strutture metalliche / Metal structures



Modesty panel

Modesty panel sp. 1.8 cm, in melaminico / Modesty panel 1.8 cm thick, in melamine

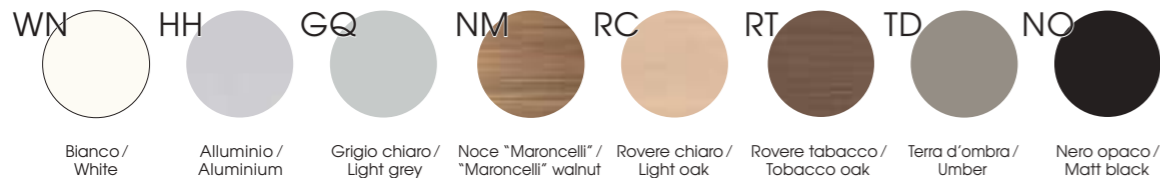

Mobili di servizio / Service units

Scocca e ripiani sp. 1.8 cm, in melaminico / Bodies and shelves 1.8 cm thick, in melamine



Ante scorrevoli sp. 1.8 cm, in melaminico con bordo ABS sp. 0.15 cm colore alluminio / Sliding doors 1.8 cm thick, in melamine with aluminium-coloured ABS edge-profiles 0.15 cm thick

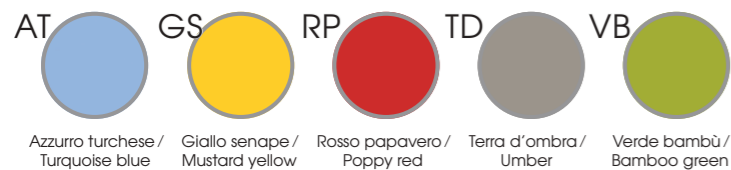

Ante scorrevoli sp. 1.8 cm, in melaminico con bordo ABS sp. 0.15 cm in tinta / Sliding doors 1.8 cm thick, in melamine with ABS edge-profiles 0.15 cm thick, in same color

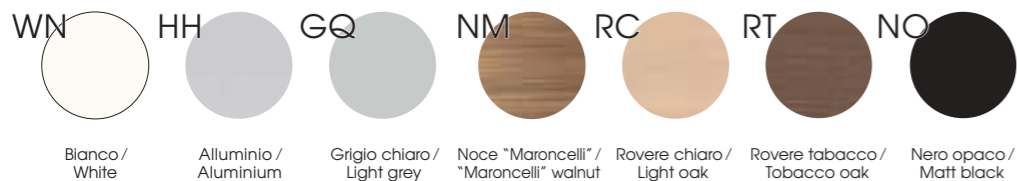

Note

Per i colori e le finiture dei Frontal Panels, vedere il relativo capitolo in DV300 - Accessori. / For colours and finishes of Frontal Panels, see the chapter in DV300 - Accessories.
 □ Prodotti non in pronta consegna. Per la disponibilità contattare l'ufficio commerciale. / Items not in prompt delivery. Please contact the commercial department to check availability.

Piani di lavoro in melaminico sp. 18 mm con bordi perimetrali in ABS / Worktops in melamine 23/32" thick with perimetrical edges in ABS

Tavoli scrivania P 65 / Desks 65 depth

P 65 x H 74

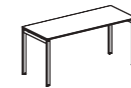

802.TS.01.08_L 80
802.TS.01.10_L 100
802.TS.01.12_L 120
802.TS.01.14_L 140

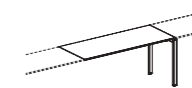

802.TS.05.08_L 80
802.TS.05.10_L 100
802.TS.05.12_L 120
802.TS.05.14_L 140

Tavoli scrivania P 80 / Desks 80 depth

P 80 x H 74



802.TS.02.08_L 80
802.TS.02.10_L 100
802.TS.02.12_L 120
802.TS.02.14_L 140

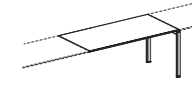

802.TS.06.08_L 80
802.TS.06.10_L 100
802.TS.06.12_L 120
802.TS.06.14_L 140

Tavolo riunioni / Conference tables

P 120 x H 74



802.TR.40.24_L 240

Tavoli executive P 90 / 90 depth executive tables

P 90 x H 74

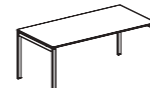

802.TS.03.18_L 180
802.TS.03.20_L 200

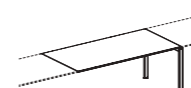

802.TS.07.18_L 180
802.TS.07.20_L 200

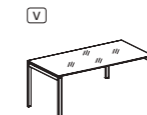

802.TV.03.20_L 200
Vetro / Glass

Allunghi laterali / Lateral extensions

P 65 x H 74



802.TD.01.08_L 80
802.TD.01.10_L 100
802.TD.01.12_L 120

P 80 x H 74

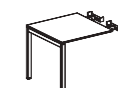

802.TD.02.08_L 80
802.TD.02.10_L 100
802.TD.02.12_L 120

P 65 x H 1,8

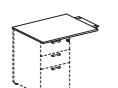

802.AL.01.08_L 80
802.AL.01.10_L 100
802.AL.01.12_L 120

Tavoli scrivania P 136,5 / Desks 136,5 depth

P 136,5 x H 74

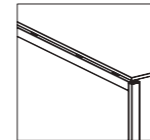

802.TS.37.14_L 140
802.TS.37.16_L 160
802.TS.37.18_L 180

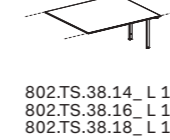

802.TS.38.14_L 140
802.TS.38.16_L 160
802.TS.38.18_L 180

Tavoli P 136,5 a 2 scrivanie contrapposte / Benches 136,5 depth

P 136,5 x H 74

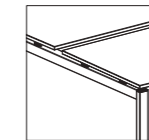

802.TB.01.08_L 80
802.TB.01.10_L 100
802.TB.01.12_L 120
802.TB.01.14_L 140
802.TB.01.16_L 160
802.TB.01.18_L 180
802.TB.01.20_L 200

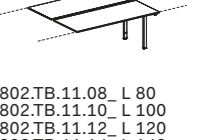

802.TB.11.08_L 80
802.TB.11.10_L 100
802.TB.11.12_L 120
802.TB.11.14_L 140
802.TB.11.16_L 160
802.TB.11.18_L 180
802.TB.11.20_L 200

Tavoli P 136,5 a 2 scrivanie contrapposte + binario centrale / Benches 136,5 depth + central rail

P 136,5 x H 74

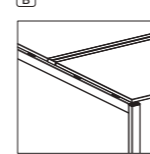

802.TB.03.12_L 120
802.TB.03.14_L 140
802.TB.03.16_L 160
802.TB.03.18_L 180
802.TB.03.20_L 200

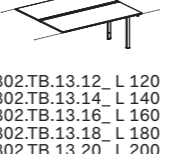

802.TB.13.12_L 120
802.TB.13.14_L 140
802.TB.13.16_L 160
802.TB.13.18_L 180
802.TB.13.20_L 200

Tavoli P 158 a 2 scrivanie contrapposte + binario centrale con 2 sportelli / Benches 158 depth + central rail with 2 flip-up covers

P 158 x H 74

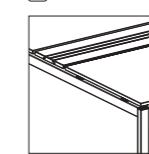

802.TB.23.12_L 120
802.TB.23.14_L 140
802.TB.23.16_L 160
802.TB.23.18_L 180
802.TB.23.20_L 200

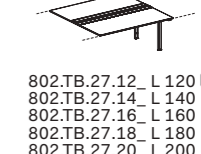

802.TB.27.12_L 120
802.TB.27.14_L 140
802.TB.27.16_L 160
802.TB.27.18_L 180
802.TB.27.20_L 200

Tavoli scrivania doppia P 158 con asole e 2 top access / Benches 158 depth with opening and 2 top access

P 158 x H 74

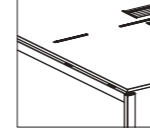

802.TB.25.14_L 140
802.TB.25.16_L 160
802.TB.25.18_L 180

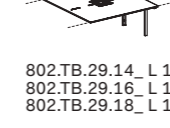

802.TB.29.14_L 140
802.TB.29.16_L 160
802.TB.29.18_L 180

Tavoli P 166,5 a 2 scrivanie contrapposte / Benches 166,5 depth

P 166,5 x H 74

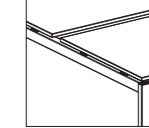

802.TB.06.08_L 80
802.TB.06.10_L 100
802.TB.06.12_L 120
802.TB.06.14_L 140
802.TB.06.16_L 160
802.TB.06.18_L 180
802.TB.06.20_L 200

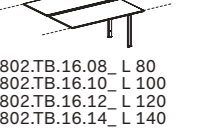

802.TB.16.08_L 80
802.TB.16.10_L 100
802.TB.16.12_L 120
802.TB.16.14_L 140
802.TB.16.16_L 160
802.TB.16.18_L 180
802.TB.16.20_L 200

Note:

1 Le dimensioni sono espresse in cm - consultare il listino prezzi per le caratteristiche tecniche, i codici degli articoli e delle finiture / Dimensions are stated in cm - for technical characteristics, article code numbers and finishing see price list;

□ Prodotti non in pronta consegna. Per la disponibilità contattare l'ufficio commerciale / Items not in prompt delivery. Please contact the commercial department to check availability;

V Vetro / Glass.

B Con binario centrale / With central rail;

Piani di lavoro in melaminico sp. 18 mm con bordi perimetrali in ABS/Worktops in melamine 23/32" thick with perimetrical edges in ABS

Tavoli P 166,5 a 2 scrivanie contrapposte + binario centrale/Benches 166,5 depth + central rail

P 166,5 x H 74

802.TB.08.12_L 120
802.TB.08.14_L 140
802.TB.08.16_L 160
802.TB.08.18_L 180
802.TB.08.20_L 200

802.TB.18.12_L 120
802.TB.18.14_L 140
802.TB.18.16_L 160
802.TB.18.18_L 180
802.TB.18.20_L 200

Cassettiere portanti/Carrying pedestals

L 42 P 65 x H 71,5

H 1,8

550.CG.13.04_Top

H 2,5

550.CG.11.04_Zoccolo (Optional) /Base frame (Optional)

802.CG.07.00

550.CS.30.04_

550.CS.40.04_

Contenitori H 74/Storage units H 74

L 80 P 33 x 71,5

H 1,8

550.CG.13.08_Top

H 2,5

550.CG.11.08_Zoccolo (Optional) /Base frame (Optional)

802.CG.07.00

550.CG.01.08_A giorno/Open

550.CC.02.08_Con ante/With doors

Cassettiere/Pedestals

L 42 P 57 x H 55,5

L 32,2 P 54,2 x H 55,5

L 42,2 P 54,2 x H 55,5

L 33 P 53 x H 44

L 32,5 P 52 x H 14,5

550.CS.10.04_Melaminico/Melamine

550.CS.20.04_Melaminico/Melamine

550.CS.1M.03_Metalliche/Metallic

550.CS.2M.03_Metalliche/Metallic

550.CS.1M.04_Metalliche - Vaschetta porta cancelleria inclusa/Metallic - Stationery tray included

550.CS.2M.04_Metalliche - Vaschetta porta cancelleria inclusa/Metallic - Stationery tray included

802.CS.11.03_Sospesa melaminico /Hanged melamine

802.CA.01.05_Sospesa metallica /Hanged metallic

Note: Per portacancelleria cassetti, vedi capitolo DV300-Accessori/ For stationary tray, see chapter DV300-Accessories

Tavoli integrabili su mobili di servizio/Integrable desks for service units

P 65 x H 74

P 80 x H 74

P 90 x H 74

P 136,5 x H 74

802.TI.01.16_L 160
802.TI.01.18_L 180
802.TI.01.20_L 200

802.TI.02.16_L 160
802.TI.02.18_L 180
802.TI.02.20_L 200

802.TI.03.18_L 180
802.TI.03.20_L 200

802.TI.04.14_L 140
802.TI.04.16_L 160
802.TI.04.18_L 180

802.TI.05.16_L 160
802.TI.05.18_L 180
802.TI.05.20_L 200

802.TI.06.16_L 160
802.TI.06.18_L 180
802.TI.06.20_L 200

P 158 x H 74

P 166,5 x H 74

802.TI.07.14_L 140
802.TI.07.16_L 160
802.TI.07.18_L 180

802.TI.08.16_L 160
802.TI.08.18_L 180
802.TI.08.20_L 200

802.TI.10.16_L 160
802.TI.10.18_L 180
802.TI.10.20_L 200

802.TI.11.16_L 160
802.TI.11.18_L 180
802.TI.11.20_L 200

Mobili di servizio con ante scorrevoli/Service units with sliding doors

L 160 P 48 x H 58

L 160 P 48 x H 58

Optional 802.CA.01.03

Optional 503.CS.P1.00

Optional 503.CS.A5.04

802.MS.02.16_Monofacciale/Unifacial

802.MS.01.16_Bifacciale/Bifacial

Optional per cod. 802.MS.02.16_/802.MS.01.16_
Optional for code 802.MS.02.16_/802.MS.01.16_

Contenitori terminali con ante scorrevoli /Terminal storage units with sliding doors

P 40 x H 40

802.CT.02.13_L 136,5
802.CT.02.15_L 158
802.CT.02.16_L 166,5

Note:
 1 Le dimensioni sono espresse in cm - consultare il listino prezzi per le caratteristiche tecniche, i codici degli articoli e delle finiture/Dimensions are stated in cm - for technical characteristics, article code numbers and finishing see price list;
 2 Prodotti non in pronta consegna. Per la disponibilità contattare l'ufficio commerciale/items not in prompt delivery. Please contact the commercial department to check availability;
 3 Con serratura/With lock;
 4 Con binario centrale/With central rail;

Piani di lavoro in melaminico sp. 18 mm con bordi perimetrali in ABS/Worktops in melamine 23/32" thick with perimetrical edges in ABS

Gambe fisse terminali/Fix terminal legs

P 5 x H 71

P 5 x H 71

802.GF.01.06_L 65
802.GF.01.08_L 80
802.GF.01.09_L 90
802.GF.01.12_L 120
802.GF.01.13_L 136,5
802.GF.01.15_L 158
802.GF.01.16_L 166,5

802.GF.02.06_L 65
802.GF.02.08_L 80
802.GF.02.09_L 90
802.GF.02.12_L 120
802.GF.02.13_L 136,5
802.GF.02.15_L 158
802.GF.02.16_L 166,5

Gambe fisse intermedie/Fix middle legs

P 5 x H 71

Coppia carter per gambe intermedie/Pair of casings for middle legs

802.GF.03.06_L 65
802.GF.03.08_L 80
802.GF.03.09_L 90

802.GF.04.12_L 120
802.GF.04.13_L 136,5
802.GF.04.15_L 158
802.GF.04.16_L 166,5

802.GC.01.05_L 120-136,5
802.GC.01.07_L 158-166,5

Gamba colonna fissa /Fix column leg

L 5 P 5 x H 71

802.GF.05.01_

Gambe regolabili terminali da 65+86 /Adjustable and terminal legs H min. 65 ÷ max. 86

P 5

802.GR.02.06_L 65
802.GR.02.08_L 80
802.GR.02.09_L 90
802.GR.02.12_L 120
802.GR.02.13_L 136,5
802.GR.02.15_L 158
802.GR.02.16_L 166,5

Gambe terminali pannellate /Terminal panelled legs

P 5 x H 72

802.GP.01.06_L 65
802.GP.01.08_L 80
802.GP.01.09_L 90
802.GP.01.13_L 136,5
802.GP.01.15_L 158
802.GP.01.16_L 166,5

802.GP.02.06_L 65
802.GP.02.08_L 80
802.GP.02.09_L 90
802.GP.02.12_L 120
802.GP.02.13_L 136,5
802.GP.02.15_L 158
802.GP.02.16_L 166,5

Gambe terminali chiuse /Terminal closed legs

P 5 x H 72

802.GL.01.06_L 65
802.GL.01.08_L 80
802.GL.01.09_L 90
802.GL.01.13_L 136,5
802.GL.01.15_L 158
802.GL.01.16_L 166,5

802.GL.02.06_L 65
802.GL.02.08_L 80
802.GL.02.09_L 90
802.GL.02.12_L 120
802.GL.02.13_L 136,5
802.GL.02.15_L 158
802.GL.02.16_L 166,5

Note: N.B. Le gambe regolabili non sono utilizzabili su tavoli integrati con mobili di servizio e cassettiere portanti /Height adjustable legs cannot be used on tables supported by service units and carrying pedestals

Supporto per M.D.S. 2 Ante scorrevoli /Support for service unit 2 sliding doors

802.KT.01.06_L 65
802.KT.01.08_L 80
802.KT.01.09_L 90
802.KT.01.13_L 136,5
802.KT.01.15_L 158
802.KT.01.16_L 166,5

Piani terminali/Terminal tops

P 40 x H 1,8

P 65 x H 74

802.PT.01.13_L 136,5
802.PT.01.15_L 158
802.PT.01.16_L 166,5

802.PT.02.13_L 136,5
802.PT.02.15_L 158
802.PT.02.16_L 166,5

Componenti per tavoli/Components for desks

P 65 x H 1,8

P 80 x H 1,8

802.PD.01.08_L 80
802.PD.01.10_L 100
802.PD.01.12_L 120

802.PD.02.08_L 80
802.PD.02.10_L 100
802.PD.02.12_L 120

Piani/Worktops

P 65 x H 1,8

P 80 x H 1,8

P 90 x H 1,8

P 120 x H 1,8

P 136,5 x H 1,8

P 136,5 x H 1,8

P 136,5 x H 1,8

802.PS.01.08_L 80
802.PS.01.10_L 100
802.PS.01.12_L 120
802.PS.01.14_L 140
802.PS.01.16_L 160
802.PS.01.18_L 180
802.PS.01.20_L 200

802.PS.02.08_L 80
802.PS.02.10_L 100
802.PS.02.12_L 120
802.PS.02.14_L 140
802.PS.02.16_L 160
802.PS.02.18_L 180
802.PS.02.20_L 200

802.PS.03.18_L 180
802.PS.03.20_L 200

802.PS.14.24_L 240

802.PR.06.14_L 140
802.PR.06.16_L 160
802.PR.06.18_L 180

802.PB.01.08_L 80
802.PB.01.10_L 100
802.PB.01.12_L 120
802.PB.01.14_L 140
802.PB.01.16_L 160
802.PB.01.18_L 180
802.PB.01.20_L 200

802.PB.03.12_L 120
802.PB.03.14_L 140
802.PB.03.16_L 160
802.PB.03.18_L 180
802.PB.03.20_L 200

802.PB.25.14_L 140
802.PB.25.16_L 160
802.PB.25.18_L 180

802.PB.23.12_L 120
802.PB.23.14_L 140
802.PB.23.16_L 160
802.PB.23.18_L 180
802.PB.23.20_L 200

802.PB.06.08_L 80
802.PB.06.10_L 100
802.PB.06.12_L 120
802.PB.06.14_L 140
802.PB.06.16_L 160
802.PB.06.18_L 180
802.PB.06.20_L 200

802.PB.08.12_L 120
802.PB.08.14_L 140
802.PB.08.16_L 160
802.PB.08.18_L 180
802.PB.08.20_L 200

Note:
 1 Le dimensioni sono espresse in cm - consultare il listino prezzi per le caratteristiche tecniche, i codici degli articoli e delle finiture/Dimensions are stated in cm - for technical characteristics, article code numbers and finishing see price list;
 2 Prodotti non in pronta consegna. Per la disponibilità contattare l'ufficio commerciale/items not in prompt delivery. Please contact the commercial department to check availability;
 3 Con binario centrale/With central rail;

Morsetti e supporti in ABS per frontal panels Sp. 0,5 - 0,8 - 1 - 3 / ABS clamps for frontal panels T. 0,5 - 0,8 - 1 - 3 ^(A)

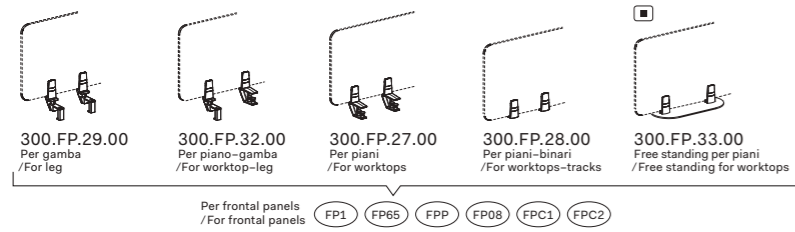

Morsetti e supporti in ZAMA per frontal panels Sp. 0,5 - 0,8 - 1 - 3 / Zamak clamps for frontal panels T. 0,5 - 0,8 - 1 - 3 ^(Z)

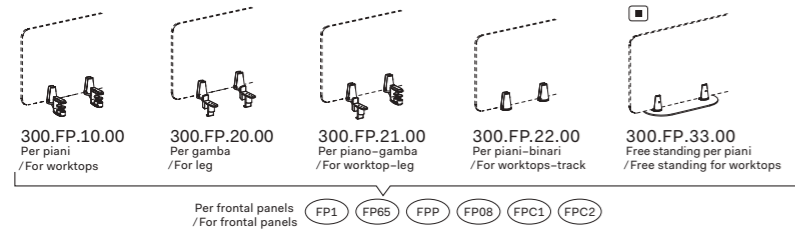

Frontal panels con morsetti e supporti integrati / Frontal panels with clamps and conic clamps

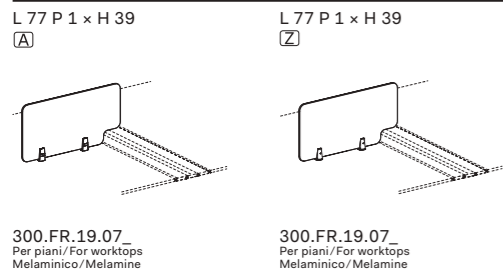

Frontal panels sp. 1 - sp. 0,8

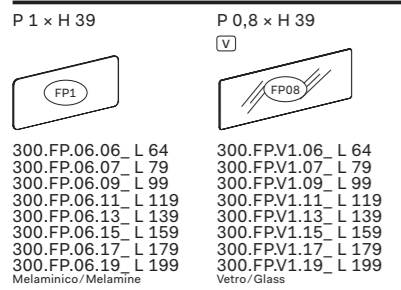

Frontal panel fonoassorbenti sp. 3 / Acoustic frontal panels t. 3

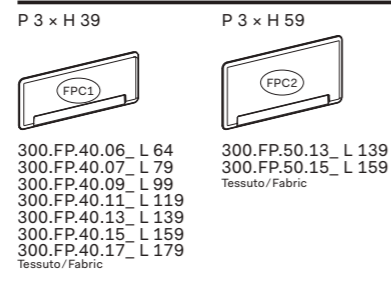

Frontal panels H 65

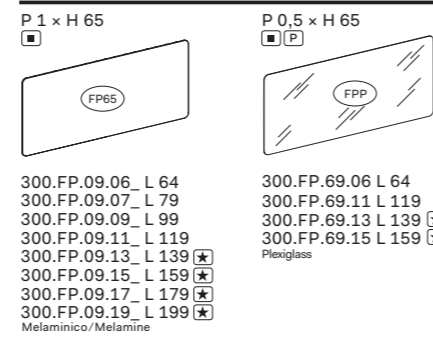

N.B.: Per i frontal con lunghezza maggiore o uguale ai 139 cm, ordinare 2 kit di supporti per frontal panel / Note: For frontal panels with a length greater than or equal to 139 cm, order 2 kits of clamps-supports for frontal panels

Accessori per frontal panels in melaminico / Accessories for melamine frontal panels

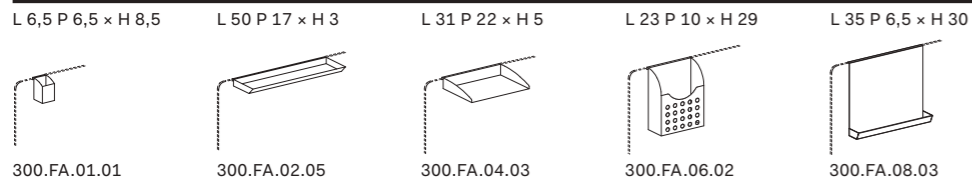

Note: Il posizionamento degli accessori sui frontal panel in vetro prevede l'utilizzo di una guarnizione in PVC trasparente (Optional su richiesta) / Placement of accessories on glass front panel need the use of a transparent PVC gasket (Optional on request) Non utilizzabile su frontal panels in plexiglass e frontal panels in tessuto fonoassorbente / Not usable for plexiglass frontal panels and acoustic frontal panels

Note:

Le dimensioni sono espresse in cm - consultare il listino prezzi per le caratteristiche tecniche, i codici degli articoli e delle finiture / Dimensions are stated in cm - for technical characteristics, article code numbers and finishing see price list;

Prodotti non in pronta consegna. Per la disponibilità contattare l'ufficio commerciale / Items not in prompt delivery. Please contact the commercial department to check availability;

Morsetti o supporti in ABS / ABS clamps
Morsetti o supporti in ZAMA / Zamak clamps
Vetro / Glass.
Plexiglass

Bracci porta video / Arms for video support

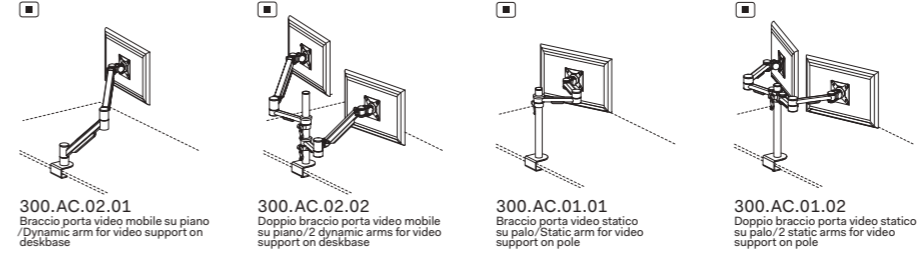

Canalizzazione - Elettificazione - Accessori / Wire management - Electrification - Accessories

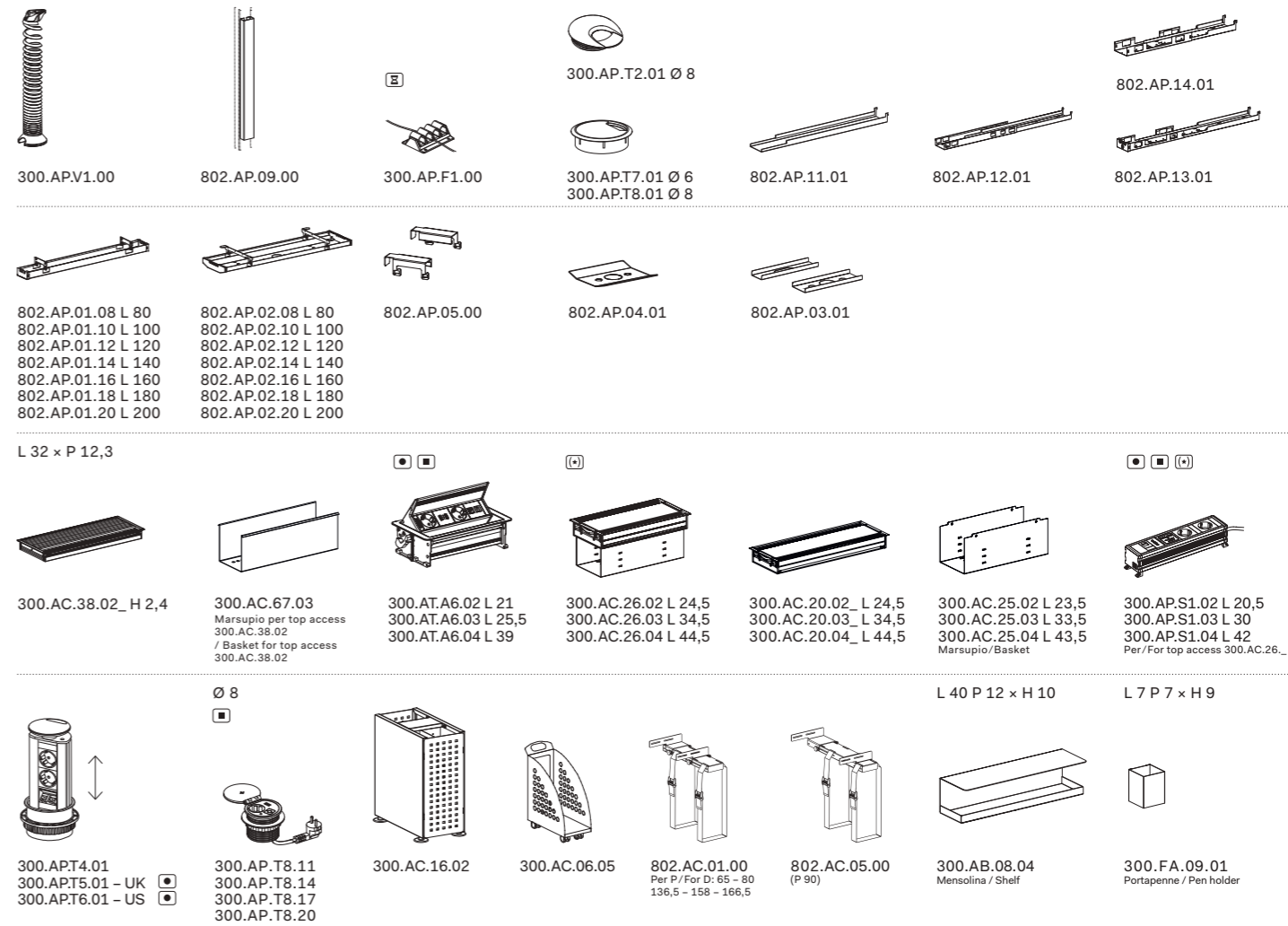

Accessori su binari / Accessories on rail

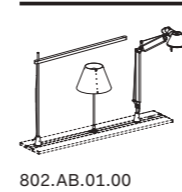

802.AB.01.00

Porta dox / Top box

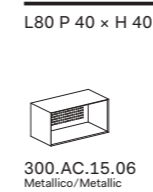

300.AC.15.06 Metallico / Metallic

Modesty panels

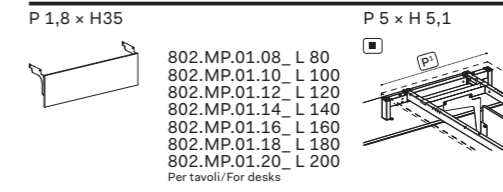

802.MP.01.08_L 80
802.MP.01.10_L 100
802.MP.01.12_L 120
802.MP.01.14_L 140
802.MP.01.16_L 160
802.MP.01.18_L 180
802.MP.01.20_L 200
Per tavoli / For desks

802.ST.01.65 L 35,5 ^(P) 65
802.ST.01.80 L 48,3 ^(P) 80
802.ST.01.90 L 58,3 ^(P) 90
Note: Staffa da aggiungere ai modesty panel per mobili di servizio in base alla profondità del piano di lavoro. Per l'integrazione consultare il relativo listino / Bracket to be added to the modesty panels for service units, depending on worktop's depth. Check the correspondent price list for the integration

Note:

Le dimensioni sono espresse in cm - consultare il listino prezzi per le caratteristiche tecniche, i codici degli articoli e delle finiture / Dimensions are stated in cm - for technical characteristics, article code numbers and finishing see price list;
Per la scelta dei contenitori e degli accessori vari, consultare il relativo listino o catalogo / To choose storage units and accessories, please check correspondent price list or catalogue;

Prodotti non in pronta consegna. Per la disponibilità contattare l'ufficio commerciale / Items not in prompt delivery. Please contact the commercial department to check availability;

Articoli prodotti solo su richiesta / Items produced only on demand;

Fino ad esaurimento / Until exhaustion;

Nobu

DV803

La scrivania di design per ufficio si pone come prodotto che predilige l'operatività e, con la sua leggerezza strutturale e forme minimali ed eleganti, configura e personalizza gli ambienti di lavoro.

Arises as a product favouring operations, with its light design of structure added to the minimal and elegant shapes it configures and customizes any workplace.









Scrivanie regolabili
in altezza con
manovella secondo
le attuali normative.
Sullo sfondo i tavoli
pieghevoli utilizzabili
all'occorrenza.

*Height-adjustable
desks with a crank
system, in accordance
with current regulations.
In the background
folding tables available
in case of need.*



Funzionale operatività
di gruppo, in cui
postazioni
di lavoro contrapposte
integrano, con
rigore e simmetria,
ampie scrivanie con
tavoli in allungo.



*Functional teamwork,
in which opposing
workstations integrate,
with rigor and
symmetry, large
desks with
extension tables.*





Tavoli / Tables

Plani di lavoro sp. 2.5 cm, in melaminico con bordi perimetrali in ABS sp. 0.2 cm / Worktops 2.5 cm thick, in melamine with 0.2 cm ABS edge-profiles
Modesty panel sp. 1.8 cm, in melaminico/Modesty panel 1.8 cm thick, in melamine



Strutture metalliche / Metal structures

(*) Strutture metalliche con regolazione in altezza elettrica solo in bianco/(*)Metal structures with electric height adjustment only in white)



Mobili di servizio / Service units

Scocca e ripiani sp. 1.8 cm, in melaminico / Bodies and shelves 1.8 cm thick, in melamine



Ante scorrevoli sp. 1.8 cm, in melaminico con bordo ABS sp. 0.15 cm colore alluminio / Sliding doors 1.8 cm thick, in melamine with aluminium-coloured ABS edge-profiles 0.15 cm thick

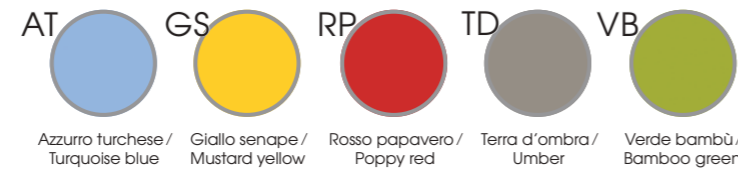

Ante scorrevoli sp. 1.8 cm, in melaminico con bordo ABS sp. 0.15 cm in tinta / Sliding doors 1.8 cm thick, in melamine with ABS edge-profiles 0.15 cm thick, in same color

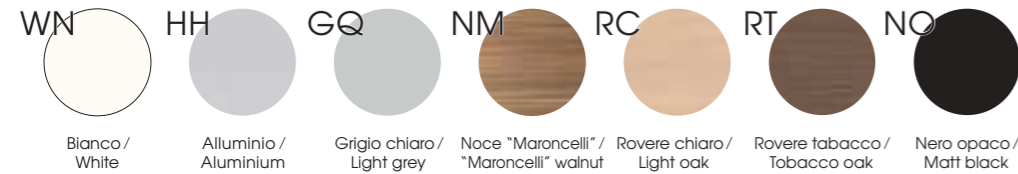

Tavoli con piano ribaltabile / Tables with folding worktop

Plani di lavoro sp. 2.5 cm, in melaminico con bordi in ABS sp. 0.2 cm / Worktops 2.5 cm thick, in melamine with ABS edge-profiles 0.2 cm thick



Strutture metalliche / Metal structures

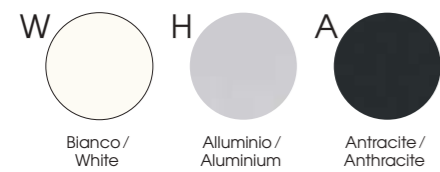

Modesty panel in tessuto / Fabric modesty panel



Frontal panels con telaio metallico / Frontal panels with metal frame

Rivestimento in tessuto 100% poliestere Trevira CS - JET Bioactive / 100% polyester Trevira CS - JET Bioactive fabric coating

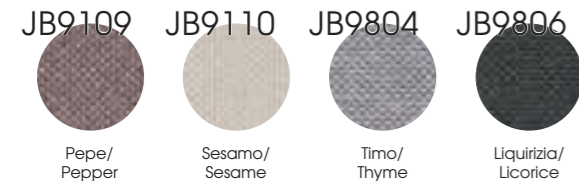

Note

Per i colori e le finiture dei Frontal Panels, vedere il relativo capitolo in DV300 - Accessori. / For colours and finishes of Frontal Panels, see the chapter in DV300 - Accessories.
[] Prodotti non in pronta consegna. Per la disponibilità contattare l'ufficio commerciale. / Items not in prompt delivery. Please contact the commercial department to check availability.

Piani di lavoro in melaminico sp. 25 mm con bordi perimetrali in ABS / Worktops in melamine 1" thick with perimetrical edges in ABS

Tavoli scrivania altezza fissa H 74 (tipo C) / Fix desks height, H 74 cm (type C)

Tavoli scrivania / Desks

P 65 x H 74

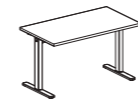

803.TS.01.08_L 80
803.TS.01.10_L 100
803.TS.01.12_L 120
803.TS.01.14_L 140
803.TS.01.16_L 160
803.TS.01.18_L 180

P 80 x H 74



803.TS.05.08_L 80
803.TS.05.10_L 100
803.TS.05.12_L 120
803.TS.05.14_L 140
803.TS.05.16_L 160
803.TS.05.18_L 180

Tavoli executive / Executive tables

P 100 x H 74

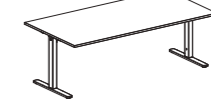

803.TS.03.20_L 200
803.TS.02.08_L 80
803.TS.02.10_L 100
803.TS.02.12_L 120
803.TS.02.14_L 140
803.TS.02.16_L 160
803.TS.02.18_L 180
803.TS.02.20_L 200

Allunghi laterali (Dx - Sx) / Lateral extension (R - L)

P 65 x H 74

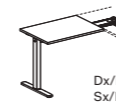

803.TD.01.08_L 80
803.TD.01.10_L 100
803.TD.01.12_L 120

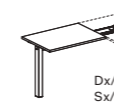

803.TD.07.08_L 80
803.TD.07.10_L 100
803.TD.07.12_L 120

Allunghi su cassettiere portanti / Extensions on carrying pedestals

L 100 P 65 x H 74



803.AL.01.10_



803.AL.06.10_

Cassettiere portanti / Carrying pedestals

L 42 P 65 x H 71,5



550.CS.30.04_



550.CS.40.04_

H 2,5



550.CG.14.04_ Top

H 1,8



550.CG.12.04 Zoccolo (Optional) / Base frame (Optional)

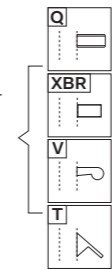

L 14,5 P 53 x H 8,5

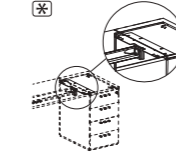

803.ST.01.00

Contenitori H 74 / Storage units H 74

L 80 P 33 x 71,5

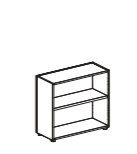

550.CG.01.08_ A giorno / Open

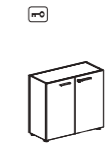

550.CC.02.08_ Con ante / With doors

H 2,5



550.CG.14.08_ Top

H 1,8



550.CG.12.08 Zoccolo (Optional) / Base frame (Optional)

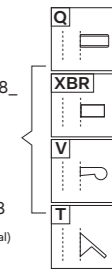

Tavoli P 136,5 e 166,5 a 2 scrivanie contrapposte / Benches 136,5 and 166,5 depth

P 136,5 x H 74

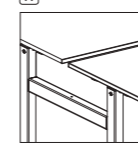

803.TB.01.14_L 140
803.TB.01.16_L 160



803.TB.11.14_L 140
803.TB.11.16_L 160

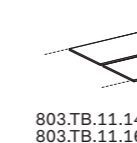

803.TB.11.14_L 140
803.TB.11.16_L 160

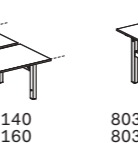

803.TB.06.14_L 140
803.TB.06.16_L 160

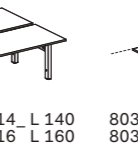

803.TB.16.14_L 140
803.TB.16.16_L 160

Cassettiere / Pedestals

L 42 P 57 x H 55,5



550.CS.10.04_ Melaminico / Melamine



550.CS.20.04_ Melaminico / Melamine

L 32,2 P 54,2 x H 55,5

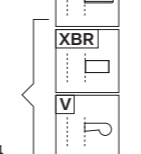

550.CS.1M.03_ Metalliche / Metallic



550.CS.2M.03_ Metalliche / Metallic

L 42,2 P 54,2 x H 55,5



550.CS.1M.04_ Metalliche - Vaschetta porta cancelleria inclusa / Metallic - Stationery tray included



550.CS.2M.04_ Metalliche - Vaschetta porta cancelleria inclusa / Metallic - Stationery tray included

Note: Per portacancelleria cassetti, vedi capitolo DV300-Accessori / For stationary tray, see chapter DV300-Accessories

Note:

[1] Le dimensioni sono espresse in cm - consultare il listino prezzi per le caratteristiche tecniche, i codici degli articoli e delle finiture / Dimensions are stated in cm - for technical characteristics, article code numbers and finishing see price list;

[] Prodotti non in pronta consegna. Per la disponibilità contattare l'ufficio commerciale / Items not in prompt delivery. Please contact the commercial department to check availability;

[A] Senza binario / Without rail;

[] Con serratura / With lock;

[X] Non utilizzabili su tavoli regolabili / Can not be used on adjustable tables.

Piani di lavoro in melaminico sp. 25 mm con bordi perimetrali in ABS/Worktops in melamine 1" thick with perimetrical edges in ABS

Cassettiere sospese/Hanged pedestals

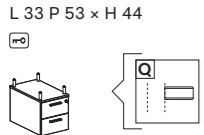
L 33 P 53 x H 44

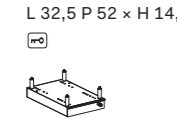
 803.CS.11.03
 Sospesa melaminico /Hanged melamine

L 32,5 P 52 x H 14,5

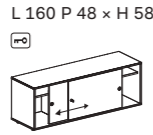
 803.CA.01.05
 Sospesa metallica /Hanged metallic

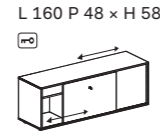
Mobili di servizio con ante scorrevoli/Service units with sliding doors

L 160 P 48 x H 58

 803.MS.02.16_
 Monofacciale/Uniface

L 160 P 48 x H 58

 803.MS.01.16_
 Bifacciale/Bifacial

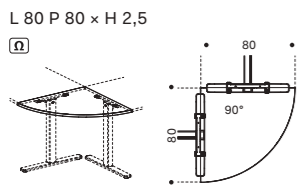
Optional 803.CA.01.03
 Optional 503.CS.P1.00
 Optional 503.CS.A5.04
 Optional per cod. 803.MS.02.16_/803.MS.01.16_
 Optional for code 803.MS.02.16_/803.MS.01.16_

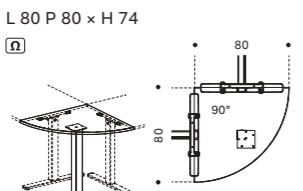
Raccordi/Connection elements

L 80 P 80 x H 2,5

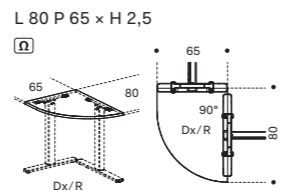
 803.RA.01.08_

L 80 P 80 x H 74

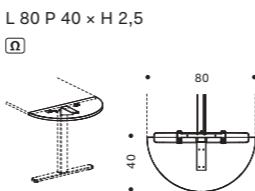
 803.RA.02.08_

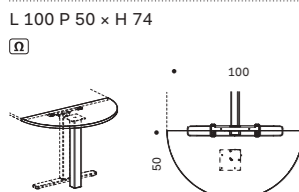
L 80 P 65 x H 2,5

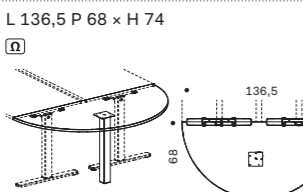
 803.RA.03.06_ Dx/R
 803.RA.04.06_ Sx/L

L 80 P 40 x H 2,5

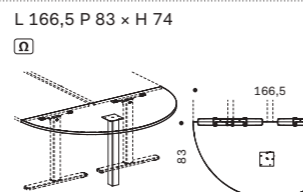
 803.PT.07.08_

L 100 P 50 x H 74

 803.PT.11.10_

L 136,5 P 68 x H 74

 803.PT.09.13_

L 166,5 P 83 x H 74

 803.PT.13.16_

Tavoli riunione/Conference tables

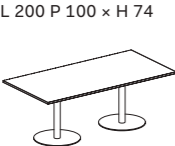
H 74

L 200 P 100 x H 74

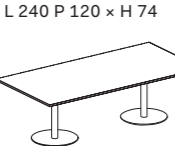
 803.TR.01.10_ Ø100
 803.TR.01.12_ Ø120

L 240 P 120 x H 74

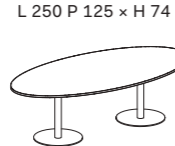
 803.TR.02.20_

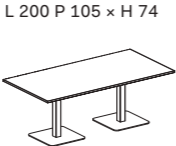
L 240 P 120 x H 74

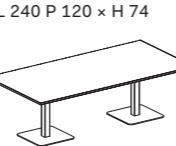
 803.TR.02.24_

L 250 P 125 x H 74

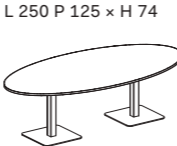
 803.TR.04.25_

L 200 P 105 x H 74

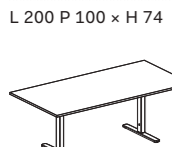
 803.TR.03.20_

L 240 P 120 x H 74

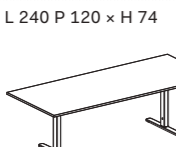
 803.TR.03.24_

L 250 P 125 x H 74

 803.TR.05.25_

L 200 P 100 x H 74

 803.TR.32.20_

L 240 P 120 x H 74

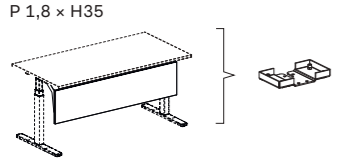
 803.TR.32.24_

L 250 P 125 x H 74

 803.TR.32.25_

Modesty panels per tavoli altezza fissa/Modesty panel for fix in height tables

P 1,8 x H35

 803.MP.01.08_ L 67
 803.MP.01.10_ L 87
 803.MP.01.12_ L 107
 803.MP.01.14_ L 127
 803.MP.01.16_ L 147
 803.MP.01.18_ L 167
 Per tavoli/For desks

803.KT.01.00
 Kit staffe/Bracket kit

Note:

1 Le dimensioni sono espresse in cm - consultare il listino prezzi per le caratteristiche tecniche, i codici degli articoli e delle finiture/Dimensions are stated in cm - for technical characteristics, article code numbers and finishing see price list;

2 Da utilizzare solo con tavoli indipendenti/To be used with single desks;

3 Con serratura / With lock;

Piani di lavoro in melaminico sp. 25 mm con bordi perimetrali in ABS/Worktops in melamine 1" thick with perimetrical edges in ABS

Tavoli scrivania posizionabili in altezza con pulsante da 65÷86 cm (tipo B-D) / Desks with adjustable height by push-button, from 65÷86 cm (type B-D)

Tavoli scrivania/Desks

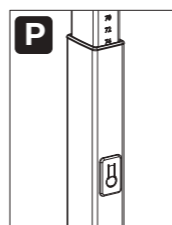
P 65 x H 65 ÷ 86

 803.TS.21.08_ L 80
 803.TS.21.10_ L 100
 803.TS.21.12_ L 120
 803.TS.21.14_ L 140
 803.TS.21.16_ L 160
 803.TS.21.18_ L 180

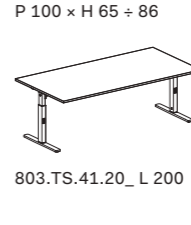
P 80 x H 65 ÷ 86

 803.TS.22.08_ L 80
 803.TS.22.10_ L 100
 803.TS.22.12_ L 120
 803.TS.22.14_ L 140
 803.TS.22.16_ L 160
 803.TS.22.18_ L 180

P 100 x H 65 ÷ 86

 803.TS.41.20_ L 200

Allunghi laterali (Dx - Sx) /Lateral extension (R - L)
 P 65 x H 65 ÷ 86

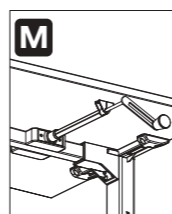
 803.TD.21.08_ L 80
 803.TD.21.10_ L 100
 803.TD.21.12_ L 120

Tavoli scrivania regolabili in altezza a due stadi con manovella da H 74 ÷ 112 cm /Adjustable height table with 2-stage height adjustment H 74 ÷ 112 cm with crank

Tavoli scrivania/Desks

M P 65 x H 74 ÷ 112

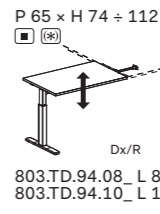
 803.TS.81.14_ L 140
 803.TS.81.16_ L 160
 803.TS.81.18_ L 180

M P 80 x H 74 ÷ 112

 803.TS.82.14_ L 140
 803.TS.82.16_ L 160
 803.TS.82.18_ L 180

Allunghi laterali/Lateral Extension
 P 65 x H 74 ÷ 112

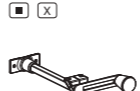
 803.TD.94.08_ L 80
 803.TD.94.10_ L 100

Note: Manovella non inclusa / Crank not included

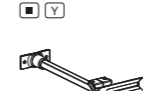
Manovelle per tavoli scrivania tipo A /Cranks for desks type A

X

 803.KT.06.00
 Per tavoli scrivania P 65
 For desks P 65

Y

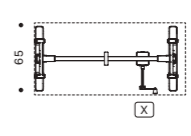
 803.KT.08.00
 Per tavoli scrivania P 80
 For desks P 80

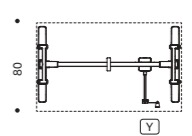
Schema tavoli con manovelle (X - Y) da aggiungere all'ordine /Desk scheme with cranks (X - Y) to be added to the order

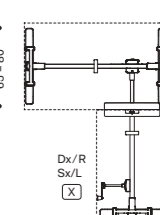
65

 X

80

 Y

65-80

 Dx/R
 Sx/L
 X

Note: Manovelle obbligatorie da aggiungere ai tavoli regolabili in altezza a due stadi (tipo A) secondo gli esempi riportati/Required cranks to be added at desks adjustable in height at two levels (type A) according to the following examples

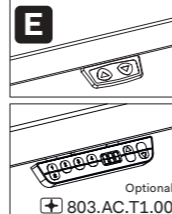
Tavoli scrivania regolabili in altezza a tre stadi elettricamente da H 65÷125 cm (tipo A) /Desks adjustable in H electrical at three stages from H 65 to H 125 cm (type A)

Tavoli scrivania/Desks

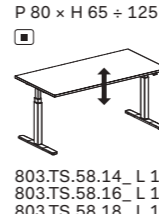
E P 65 x H 65 ÷ 125

 803.TS.57.14_ L 140
 803.TS.57.16_ L 160
 803.TS.57.18_ L 180

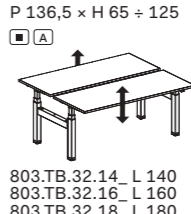
E P 80 x H 65 ÷ 125

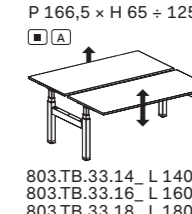
 803.TS.58.14_ L 140
 803.TS.58.16_ L 160
 803.TS.58.18_ L 180

A P 136,5 x H 65 ÷ 125

 803.TB.32.14_ L 140
 803.TB.32.16_ L 160
 803.TB.32.18_ L 180

A P 166,5 x H 65 ÷ 125

 803.TB.33.14_ L 140
 803.TB.33.16_ L 160
 803.TB.33.18_ L 180

Note:

1 Le dimensioni sono espresse in cm - consultare il listino prezzi per le caratteristiche tecniche, i codici degli articoli e delle finiture/Dimensions are stated in cm - for technical characteristics, article code numbers and finishing see price list;

2 Prodotti non in pronta consegna. Per la disponibilità contattare l'ufficio commerciale/Items not in prompt delivery. Please contact the commercial department to check availability;

3 I tavoli in allungo laterale (E) sono integrabili in versione Dx e Sx /The extension tables (E) can be used on the RH and LH side;

A Senza binario/Without rail;

4 Tastierino per regolazione altezza piano con memorie /Control pad with memories for height adjustable worktop

Piani di lavoro in melaminico sp. 25 mm con bordi perimetrali in ABS/Worktops in melamine 1" thick with perimetrical edges in ABS

Tavoli su ruote con piano ribaltabile / Tables on castors with flip worktop

P 70 x H 74

 300.TF.01.08_L 80
 300.TF.01.10_L 100
 300.TF.01.12_L 120
 300.TF.01.14_L 140
 300.TF.01.16_L 160
 300.TF.01.18_L 180

P 80 x H 74

 300.TF.02.08_L 80
 300.TF.02.10_L 100
 300.TF.02.12_L 120
 300.TF.02.14_L 140
 300.TF.02.16_L 160
 300.TF.02.18_L 180

Accessori per tavoli con piano ribaltabile / Accessories for tables with flip worktop

P 1 x H 31

 300.MP.10.08_L 46,5
 300.MP.10.10_L 66,5
 300.MP.10.12_L 86,5
 300.MP.10.14_L 106,5
 300.MP.10.16_L 126,5
 300.MP.10.18_L 146,5
 Modesty Panel per tavolo con piano ribaltabile/Modesty panel for tables with flip worktop

300.KT.04.00
 Ganci per collegare in linea tavoli folding / Hooks to connect folding desks in line

Morsetti e supporti per frontal panels Sp. 0,5 - 0,8 - 1 - 3 / Clamps for frontal panels T. 0,5 - 0,8 - 1 - 3

300.FP.27.00 Per piani / For worktops
300.FP.28.00 Per piani-binari / For worktops-track
300.FP.33.00 Free standing per piani / Free standing for worktops

300.FP.10.00 Per piani / For worktops
300.FP.22.00 Per piani-binari / For worktops-track
300.FP.33.00 Free standing per piani / Free standing for worktops

Per frontal panels / For frontal panels (FP1, FP65, FPP, FP08, FPC1, FPC2)

Frontal panels sp. 1 - sp. 0,8

P 1 x H 39

 300.FP.06.06_L 64
 300.FP.06.07_L 79
 300.FP.06.09_L 99
 300.FP.06.11_L 119
 300.FP.06.13_L 139
 300.FP.06.15_L 159
 300.FP.06.17_L 179
 300.FP.06.19_L 199
 Melaminico/Melamine

P 0,8 x H 39

 300.FP.V1.06_L 64
 300.FP.V1.07_L 79
 300.FP.V1.09_L 99
 300.FP.V1.11_L 119
 300.FP.V1.13_L 139
 300.FP.V1.15_L 159
 300.FP.V1.17_L 179
 300.FP.V1.19_L 199
 Vetro/Glass

Frontal panel fonoassorbenti sp. 3 / Acoustic frontal panels t. 3

P 3 x H 39

 300.FP.40.06_L 64
 300.FP.40.07_L 79
 300.FP.40.09_L 99
 300.FP.40.11_L 119
 300.FP.40.13_L 139
 300.FP.40.15_L 159
 300.FP.40.17_L 179
 Tessuto/Fabric

P 3 x H 59

 300.FP.50.13_L 139
 300.FP.50.15_L 159
 Tessuto/Fabric

Frontal panels H. 65

P 1 x H 65

 300.FP.09.06_L 64
 300.FP.09.07_L 79
 300.FP.09.09_L 99
 300.FP.09.11_L 119
 300.FP.09.13_L 139
 300.FP.09.15_L 159
 300.FP.09.17_L 179
 300.FP.09.19_L 199
 Melaminico/Melamine

P 0,5 x H 65

 300.FP.69.06_L 64
 300.FP.69.11_L 119
 300.FP.69.13_L 139
 300.FP.69.15_L 159
 Plexiglass

★ N.B.: Per i frontal con lunghezza maggiore o uguale ai 139 cm, ordinare 2 kit di supporti per frontal panel / Note: For frontal panels with a length greater than or equal to 139 cm, order 2 kits of clamps-supports for frontal panels

Frontal panels per bench / Frontal panels for bench

P 4 x H 79

 300.FR.36.14_L 140
 300.FR.36.16_L 160
 Tessuto/Fabric
 Per bench con altezza regolabile "tipo A" / For bench with adjustable height "type A"

Accessori / Accessories

L 6,5 P 6,5 x H 8,5

 300.FA.01.01

L 50 P 17 x H 3

 300.FA.02.05

L 31 P 22 x H 5

 300.FA.04.03

L 23 P 10 x H 29

 300.FA.06.02

L 35 P 6,5 x H 30

 300.FA.08.03

Note: Il posizionamento degli accessori sui frontal panel in vetro prevede l'utilizzo di una guarnizione in PVC trasparente (Optional su richiesta) / Placement of accessories on glass front panel need the use of a trasparente PVC gasket (Optional on request)
 Non utilizzabile su frontal panels in plexiglass e frontal panels in tessuto fonoassorbente / Not usable for plexiglass frontal panels and acoustic frontal panels

Note:
 1 Le dimensioni sono espresse in cm - consultare il listino prezzi per le caratteristiche tecniche, i codici degli articoli e delle finiture / Dimensions are stated in cm - for technical characteristics, article code numbers and finishing see price list;
 2 Prodotti non in pronta consegna. Per la disponibilità contattare l'ufficio commerciale / Items not in prompt delivery. Please contact the commercial department to check availability;
 3 Morsetti o supporti in ABS / ABS clamps
 4 Morsetti o supporti in ZAMA / Zamak clamps
 P Plexiglass
 V Vetro/Glass.

Canalizzazione - Elettrificazione / Wire management - Electrification

803.AP.08.06 Per gambe fisse "tipo C" / For fix legs height "type C"
803.AP.09.06 Per gambe regolabili "tipo B-D" / For legs with adjustable height "type B-D"
803.AP.09.00 Per tavoli con piano ribaltabile / For desk with folding worktop
300.AP.V1.00
803.CL.01.14 Per tavoli con piano ribaltabile / For desk with folding worktop
300.AP.T2.01 Ø 8
300.AP.T7.01 Ø 6
300.AP.T8.01 Ø 8

300.AC.26.02 L 24,5
300.AC.26.03 L 34,5
300.AC.26.04 L 44,5

300.AC.20.02_L L 24,5
300.AC.20.03_L L 34,5
300.AC.20.04_L L 44,5

300.AC.25.02 L 23,5
300.AC.25.03 L 33,5
300.AC.25.04 L 43,5
 Marsupio/Basket

300.AP.S1.02 L 20,5
300.AP.S1.03 L 30
300.AP.S1.04 L 42
 Per/For top access 300.AC.26_

300.AT.A6.02 L 21
300.AT.A6.03 L 25,5
300.AT.A6.04 L 39

300.AP.T8.11
300.AP.T8.14
300.AP.T8.17
300.AP.T8.20

300.APT4.01
300.APT5.01 - UK
300.APT6.01 - US

L 32 x P 12,3

300.AC.38.02_H 2,4
300.AC.67.03
 Marsupio per top access
 300.AC.38.02
 / Basket for top access
 300.AC.38.02

803.AC.01.02
300.AC.06.05

803.AC.02.02_
 Per tavoli bench regolabili in altezza elettricamente / For bench desks adjustable in height

803.AP.10.00
 Per tavoli bench regolabili in altezza elettricamente-a manovella / For bench desks adjustable in height by crank - electrical

803.AP.02.14 L 140
803.AP.02.16 L 160
803.AP.02.18 L 180
 Per tavoli a due scrivanie contrapposte / For benches

803.AP.43.14_L L 140
803.AP.43.16_L L 160
803.AP.43.18_L L 180
 Carter di copertura per canaline bench / Bench cable-channel cover casing

Bracci porta video / Arms for video support

300.AC.02.01
 Braccio porta video mobile su piano / Dynamic arm for video support on deskbase

300.AC.02.02
 Doppio braccio porta video mobile su piano / 2 dynamic arms for video support on deskbase

300.AC.01.01
 Braccio porta video statico su palo / Static arm for video support on pole

300.AC.01.02
 Doppio braccio porta video statico su palo / 2 static arms for video support on pole

Note:
 1 Le dimensioni sono espresse in cm - consultare il listino prezzi per le caratteristiche tecniche, i codici degli articoli e delle finiture / Dimensions are stated in cm - for technical characteristics, article code numbers and finishing see price list;
 2 Per la scelta dei contenitori e degli accessori vari, consultare il relativo listino o catalogo / To choose storage units and accessories, please check correspondent price list or catalogue;
 3 Prodotti non in pronta consegna. Per la disponibilità contattare l'ufficio commerciale / Items not in prompt delivery. Please contact the commercial department to check availability;
 4 Articoli prodotti solo su richiesta / Items produced only on demand;
 5 Fino ad esaurimento / Until exhaustion;

Treko

DV805

Praticità, attualità e flessibilità, sono i plus principali che consentono di arredare i moderni spazi di lavoro con estrema semplicità e funzionalità. Prospettive da manuale che mettono in evidenza la tradizionale scrivania pannellata rivista in chiave moderna.

Practicality, flexibility and timeliness, are the main features that allow to furnish modern working environments with extreme simplicity and functionality. Perspectives that emphasize the traditional panelled leg desk, reviewed with a modern eye.











Configurazione composta con raccordi a 90°. Il tutto esaltato dalla leggerezza e modernità della finitura rovere chiaro.

Configuration composed with 90° connections. All enhanced by the lightness and modernity of the light oak finish.





Questa collezione utilizza le composizioni più svariate permettendo di progettare open space o spazi delimitati creando ambienti piacevoli ed accoglienti.



This collection allows the design of endless compositions being it open spaces or defined areas, creating a pleasant and comfortable ambience.



Tavoli / Tables

Piani di lavoro, gambe pannellate sp. 2.5 cm con bordi in ABS sp. 0.2 cm e modesty panels sp. 1.8 cm, in melaminico con bordo ABS colore bianco / Worktops and panelled legs 2.5 cm thick with 0.2 cm thick ABS edgebanding, modesty panels 1.8 cm thick, in melamine with white ABS edge banding



Strutture metalliche / Metal structures

Gamboni - Colonne in metallo / Metal columns

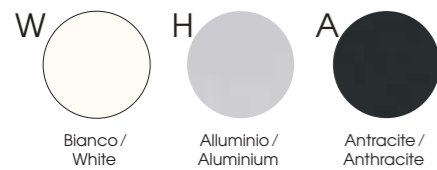

Poggiapiedi in tubo / Footrest tube



Mobili di servizio / Service units

Scocca e ripiani sp. 1.8 cm, in melaminico / Bodies and shelves 1.8 cm thick, in melamine

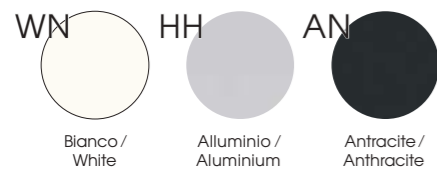

Ante scorrevoli sp. 1.8 cm, in melaminico con bordo ABS sp. 0.15 cm colore alluminio / Sliding doors 1.8 cm thick, in melamine with aluminium-coloured ABS edge-profiles 0.15 cm thick

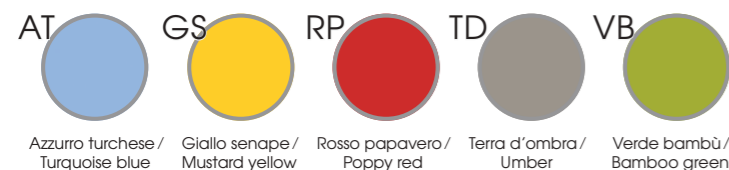

Ante scorrevoli sp. 1.8 cm, in melaminico con bordo ABS sp. 0.15 cm in tinta / Sliding doors 1.8 cm thick, in melamine with ABS edge-profiles 0.15 cm thick, in same color

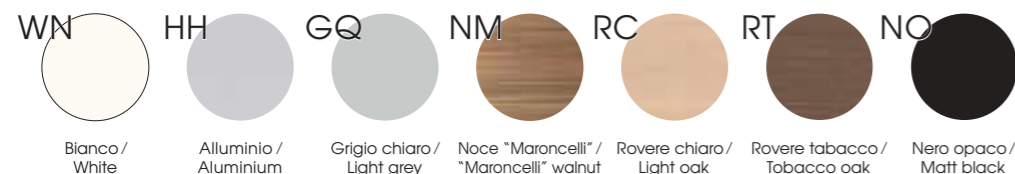

Piedini livellatori e distanziali in ABS / Adjustable feet and ABS spacers



Note: Per i colori e le finiture dei Frontal Panels, vedere il relativo capitolo in DV300 - Accessori. / For colours and finishes of Frontal Panels, see the chapter in DV300 - Accessories.
 □ Prodotti non in pronta consegna. Per la disponibilità contattare l'ufficio commerciale. / Items not in prompt delivery. Please contact the commercial department to check availability.

Piani di lavoro in melaminico sp. 25 mm con bordi perimetrali in ABS / Worktops in melamine 25 mm thick with perimetrical edges in ABS

Tavoli scrivanie / Desks

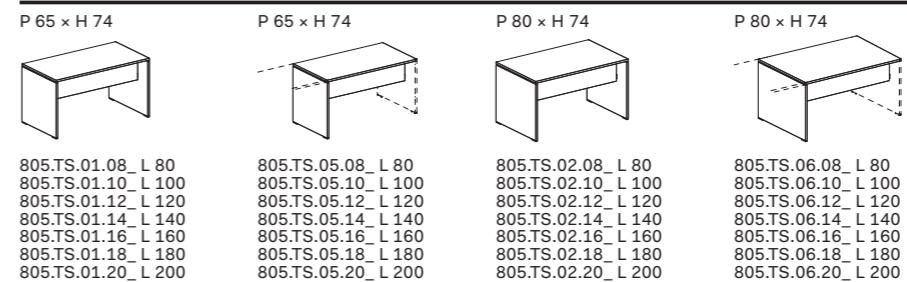

Allungo laterale / Lateral extension

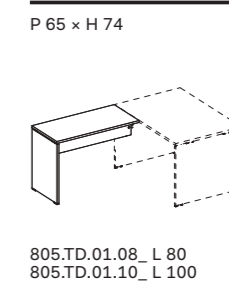

Standing tables H 107

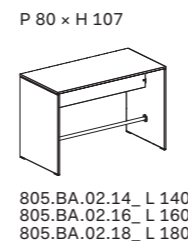

Tavoli executive / Executive tables

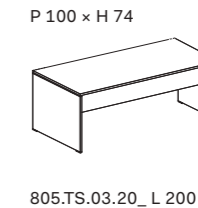

Allunghi su cassettiere portanti / Extensions on carrying pedestals

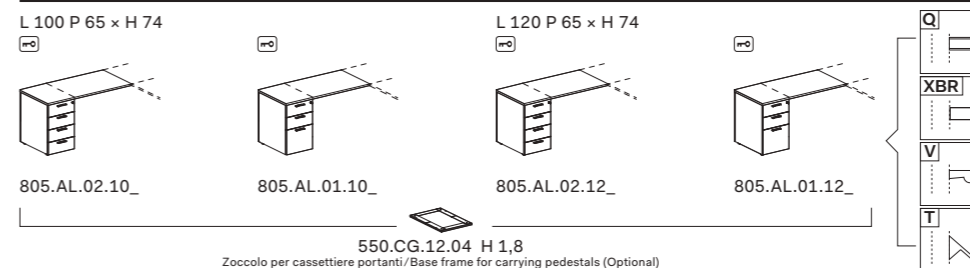

Cassettiere portanti / Carrying pedestals

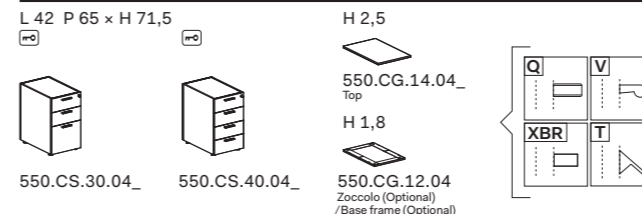

Contenitori H 74 / Storage units H 74

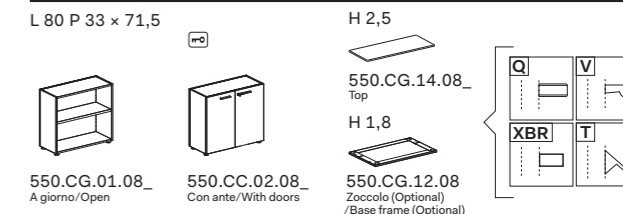

Raccordi / Connection elements

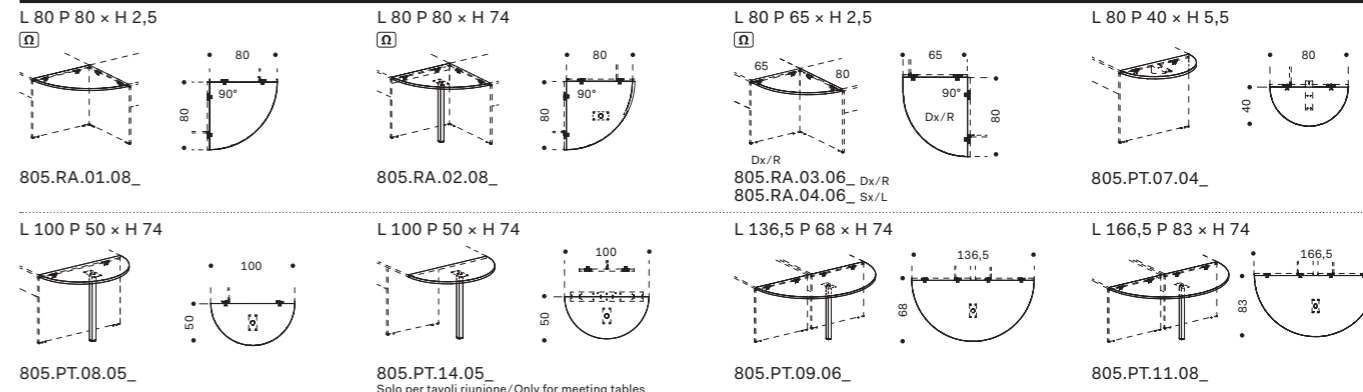

Note: □ Prodotti non in pronta consegna. Per la disponibilità contattare l'ufficio commerciale / Items not in prompt delivery. Please contact the commercial department to check availability.
 □ Da utilizzare solo con tavoli indipendenti / To be used with single desks
 □ Con serratura / With lock.

Piani di lavoro in melaminico sp. 25 mm con bordi perimetrali in ABS/Worktops in melamine 25 mm thick with perimetrical edges in ABS

Mobili di servizio/Service units

L 120 P 60 x H 61,5
550.CM.S0.12_ Su ruote/On castors
Note: Per portacassetteria cassetti, vedi capitolo DV300-Accessori / For stationary tray, see chapter DV300-Accessories.

L 160 P 48 x H 58
805.MS.02.16_ Monofacciale/Uniface

L 160 P 48 x H 58
805.MS.01.16_ Bifacciale/Bifacial

Optional 805.CA.01.03
Optional 503.CS.P1.00
Optional 503.CS.A5.04
Optional per cod. 805.MS.02.16_/805.MS.01.16_ / Optional for code 805.MS.02.16_/805.MS.01.16_

Cassettiere/Pedestals

L 42 P 57 x H 55,5
550.CS.10.04_ Melaminico/Melamine
550.CS.20.04_ Melaminico/Melamine

L 32,2 P 54,2 x H 55,6
550.CS.1M.03_ Metalliche/Metallic
550.CS.2M.03_ Metalliche/Metallic

L 42,2 P 54,2 x H 55,6
550.CS.1M.04_ Metalliche - Vaschetta porta cancelleria inclusa/Metallic - Stationery tray included
550.CS.2M.04_ Metalliche - Vaschetta porta cancelleria inclusa/Metallic - Stationery tray included

Cassettiere sospese/Hanged pedestals
L 33 - P 53 x H 35
805.CS.11.03_ Sospesa melaminico /Hanged melamine
L 32,5 P 52 x H 7
805.CA.01.04_ Sospesa metallica /Hanged metallic

Note: Per portacassetteria cassetti, vedi capitolo DV300-Accessori / For stationary tray, see chapter DV300-Accessories.

Tavoli riunione/Conference tables

H 74
L 200 P 100 x H 74
805.TR.01.10_ Ø 100
805.TR.01.12_ Ø 120

L 240 P 120 x H 74
805.TR.02.24_

L 250 P 125 x H 74
805.TR.03.24_

805.TR.32.20_

805.TR.33.20_

805.TR.02.20_

805.TR.03.20_

805.TR.32.24_

805.TR.33.24_

Morsetti e supporti in per frontal panels Sp. 0,5 - 0,8 - 1 - 3/Clamps for frontal panels T. 0,5 - 0,8 - 1 - 3

300.FP.27.00 Per piani /For worktops
300.FP.28.00 Per piani-binari /For worktops-track
300.FP.30.00 Per gamba (serie DV805) /For leg (serie DV805)
300.FP.31.00 Per piano-gamba (serie DV805)/For worktop -leg (serie DV805)
300.FP.33.00 Free standing per piani /Free standing for worktops
300.FP.10.00 Per piani /For worktops
300.FP.22.00 Per piani-binari /For worktops-track
300.FP.23.00 Per gamba (serie DV805) /For leg (serie DV805)
300.FP.24.00 Per piano-gamba (serie DV805)/For worktop -leg (serie DV805)
300.FP.33.00 Free standing per piani /Free standing for worktops

Per frontal panels/For frontal panels FP1 FP65 FPP FP08 FPC1 FPC2

Frontal panels Sp. 0,8 - 1

P 1 x H 39
FP1

P 0,8 x H 39
FP08

300.FP.06.06_ L 64
300.FP.06.07_ L 79
300.FP.06.09_ L 99
300.FP.06.11_ L 119
300.FP.06.13_ L 139
300.FP.06.15_ L 159
300.FP.06.17_ L 179
300.FP.06.19_ L 199
Melaminico/Melamine

300.FPV.06_ L 64
300.FPV.07_ L 79
300.FPV.09_ L 99
300.FPV.11_ L 119
300.FPV.13_ L 139
300.FPV.15_ L 159
300.FPV.17_ L 179
300.FPV.19_ L 199
Vetro/Glass

Frontal panel fonoassorbenti Sp. 3 /Acoustic frontals panels T. 3

P 3 x H 39
FPC1

P 3 x H 59
FPC2

300.FP.40.06_ L 64
300.FP.40.07_ L 79
300.FP.40.09_ L 99
300.FP.40.11_ L 119
300.FP.40.13_ L 139
300.FP.40.15_ L 159
300.FP.40.17_ L 179
Tessuto/Fabric

Frontal panels H 65

P 1 x H 65
FP65

P 0,5 x H 65
FPP

300.FP.09.06_ L 64
300.FP.09.07_ L 79
300.FP.09.09_ L 99
300.FP.09.11_ L 119
300.FP.09.13_ L 139
300.FP.09.15_ L 159
300.FP.09.17_ L 179
300.FP.09.19_ L 199
Melaminico/Melamine

300.FP.69.06_ L 64
300.FP.69.11_ L 119
300.FP.69.13_ L 139
300.FP.69.15_ L 159
Plexiglass

N.B.: Per i frontal con lunghezza maggiore o uguale ai 139 cm, ordinare 2 kit di supporti per frontal panel / Note: For frontal panels with a length greater than or equal to 139 cm, order 2 kits of clamps-supports for frontal panels

Accessori per frontal panels in melaminico/Accessories for melamine frontal panels

L 6,5 P 6,5 x H 8,5
300.FA.01.01

L 50 P 17 x H 3
300.FA.02.05

L 31 P 22 x H 5
300.FA.04.03

L 23 P 10 x H 29
300.FA.06.02

L 35 P 6,5 x H 30
300.FA.08.03

Note: Il posizionamento degli accessori sui frontal panel in vetro prevede l'utilizzo di una guarnizione in PVC trasparente (Optional su richiesta)/Placement of accessories on glass front panel need the use of a transparent PVC gasket (Optional on request) - Non utilizzabile su frontal panels in plexiglass e frontal panels in tessuto fonoassorbente / Not usable for plexiglass frontal panels and acoustic frontal panels

Canalizzazione - Elettrificazione - Accessori/Wire management - Electrification - Accessories

300.CL.01.40 L 115

300.AP.20.00 L 57

300.AP.F1.00

300.AP.V1.00

300.AP.T7.01 Ø 6
300.AP.T8.01 Ø 8

805.KT.01.00 Kit per 2 gambe tavoli (optional) /Kit for 2 table legs (optional)

805.KT.02.00 Kit per 1 gamba intermedia (optional) /Kit for 1 table middle leg (optional)

300.AC.26.02 L 24,5
300.AC.26.03 L 34,5
300.AC.26.04 L 44,5

300.AC.20.02_ L 24,5
300.AC.20.03_ L 34,5
300.AC.20.04_ L 44,5

300.AC.25.02 L 23,5
300.AC.25.03 L 33,5
300.AC.25.04 L 43,5
Marsupio/Basket

300.AP.S1.02 L 20,5
300.AP.S1.03 L 30
300.AP.S1.04 L 42
Per/For top access 300.AC.26_

300.AT.A6.02 L 21
300.AT.A6.03 L 25,5
300.AT.A6.04 L 39

300.AP.T8.11
300.AP.T8.14
300.AP.T8.17
300.AP.T8.20

300.AP.T4.01
300.AP.T5.01 - UK
300.AP.T6.01 - US

L 32 x P 12,3

300.AC.38.02_H 2,4

300.AC.67.03 Marsupio per top access 300.AC.38.02 /Basket for top access 300.AC.38.02

805.AC.01.00

805.AP.32.01 Per "standing tables" H 107 con top access / For H 107 "standing tables" with top access

300.AC.06.05

Bracci porta video/Arms for video support

300.AC.02.01 Braccio porta video mobile su piano/Dynamic arm for video support on deskbase

300.AC.02.02 Doppio braccio porta video mobile su piano/2 dynamic arms for video support on deskbase

300.AC.01.01 Braccio porta video statico su palo/Static arm for video support on pole

300.AC.01.02 Doppio braccio porta video statico su palo/2 static arms for videosupport on pole

Note:

- 1 Le dimensioni sono espresse in cm - consultare il listino prezzi per le caratteristiche tecniche, i codici degli articoli e delle finiture/Dimensions are stated in cm - for technical characteristics, article code numbers and finishing see price list;
- 2 Per la scelta dei contenitori e degli accessori vari, consultare il relativo listino o catalogo/To choose storage units and accessories, please check correspondent price list or catalogue;
- Prodotti non in pronta consegna. Per la disponibilità contattare l'ufficio commerciale/Items not in prompt delivery. Please contact the commercial department to check availability;
- Articoli prodotti solo su richiesta/Items produced only on demand;
- Fino ad esaurimento/Until exhaustion;
- Con serratura/With lock;
- Vetro/Glass.
- Plexiglass
- Morsetti o supporti in ABS /ABS clamps
- Morsetti o supporti in ZAMA / Zamak clamps

Enna

DV812

Design, stile e ampia flessibilità compositiva caratterizzano i tavoli di questa collezione. Le eleganti e minimali gambe free-standing, si abbinano a piani di lavoro dalle forme e dimensioni più diverse.

Design, style and wide compositional flexibility characterize the tables in this collection. The elegant and minimal free-standing legs are combined with worktops of the most diverse shapes and sizes.













L'ampia gamma di colori e finiture previste per le gambe e per i piani di lavoro, permettono di realizzare piacevoli e svariate soluzioni cromatiche.

The wide range of colours and finishes provided for the legs and the worktops, allow to create pleasant and varied chromatic solutions.



La serie operativa
è arricchita da
complementi e tanti
utili accessori.



*The operative
series is enriched
with complements
and many useful
accessories.*



Tavoli / Tables

Plani di lavoro sp. 3.8 cm, in melaminico con bordi in ABS sp. 0.2 cm / Worktops 3.8 cm thick, in melamine with ABS edge-profiles 0.2 cm thick

Piano di lavoro effetto pelle sp. 3.8 cm (per tavoli P. 90 cm, tavoli sagomati e tavoli riunione - esclusi tavoli riunione rotondi) / Leather effect worktop 3.8 cm thick (for desk D.90 cm, shaped desks and meeting tables - round meeting tables are not included)

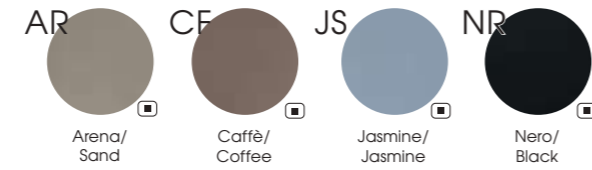
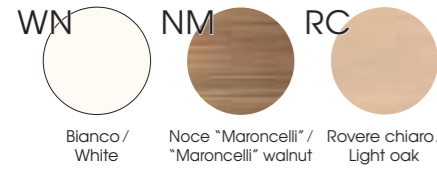

Modesty panel

Sp. 1.8 cm, in melaminico / 18 mm thick, in melamine

Sp. 1.8 cm, effetto pelle / 18 mm thick, leather effect

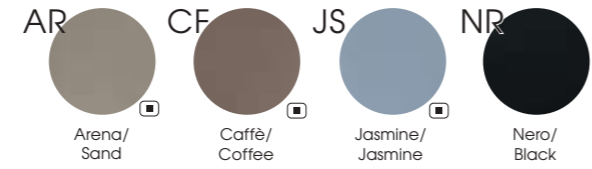
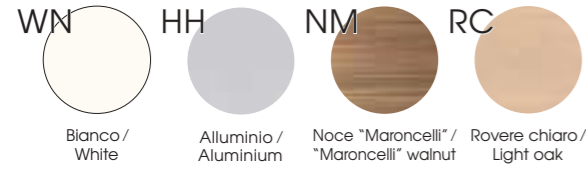

Gambe metalliche / Metal legs

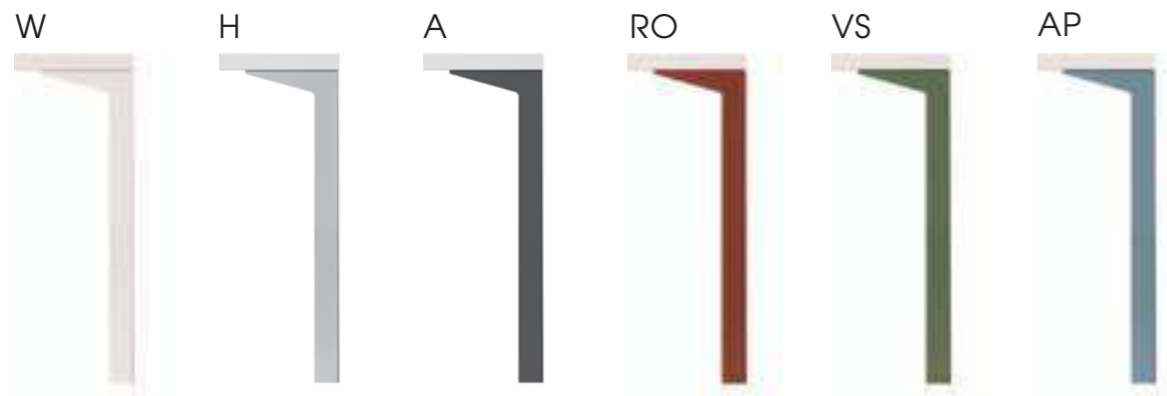

Mobili di servizio / Service units

Scocca e ripiani sp. 1.8 cm, in melaminico Bodies and shelves 1.8 cm thick, in melamine

Ante scorrevoli sp. 1.8 cm, in melaminico con bordo ABS sp. 0.15 cm colore alluminio Sliding doors 1.8 cm thick, in melamine with aluminium-coloured ABS edge-profiles 0.15 cm thick

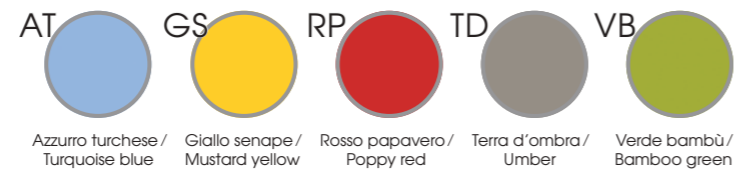
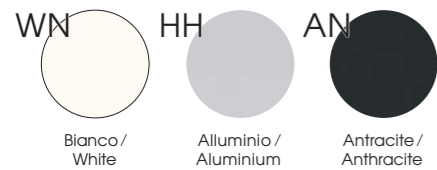

Ante scorrevoli sp. 1.8 cm, in melaminico con bordo ABS sp. 0.15 cm in tinta / Sliding doors 1.8 cm thick, in melamine with ABS edge-profiles 0.15 cm thick, in same color



Note

Per i colori e le finiture dei Frontal Panels, vedere il relativo capitolo in DV300 - Accessori. / For colours and finishes of Frontal Panels, see the chapter in DV300 - Accessories.
 □ Prodotti non in pronta consegna. Per la disponibilità contattare l'ufficio commerciale. / Items not in prompt delivery. Please contact the commercial department to check availability.

Piani di lavoro in melaminico sp. 38 mm con bordi perimetrali in ABS / Worktops in melamine 1 1/2" thick with perimetrical edges in ABS

Tavoli scrivanie/Desks

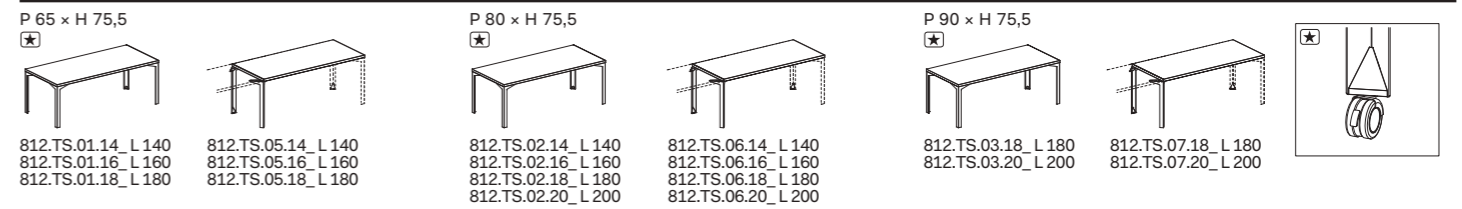

Tavoli alti H 107 / Standing tables H 107

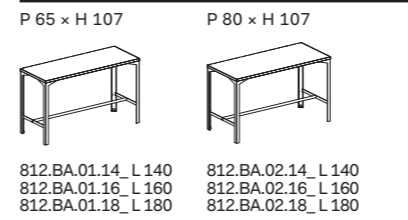

Tavoli scrivania sagomati / Shaped desks

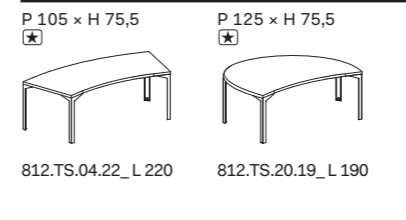

Allunghi laterali / Lateral extensions

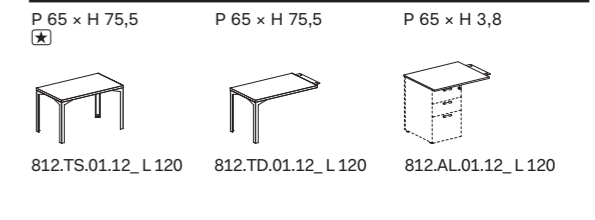

Cassettiere portanti/Carrying pedestals

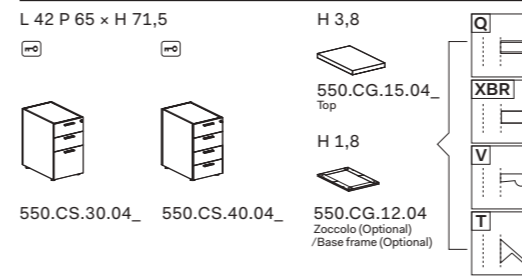

Contenitori H 75,5/Storage units H 75,5

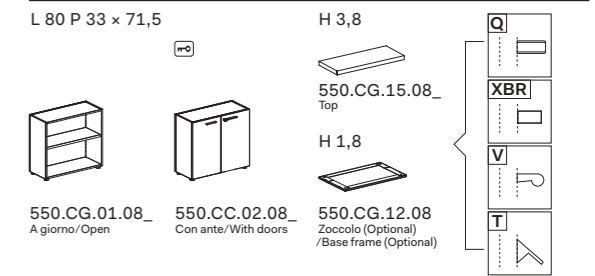

Tavoli a 2 scrivanie contrapposte/Benches

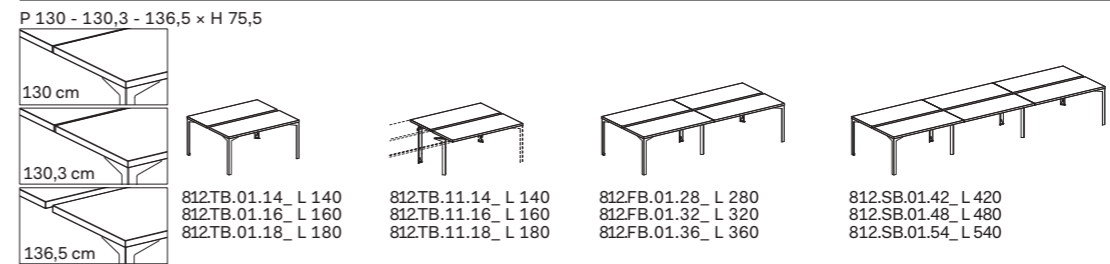

Tavoli a 2 scrivanie contrapposte + binario centrale / Benches + central rail

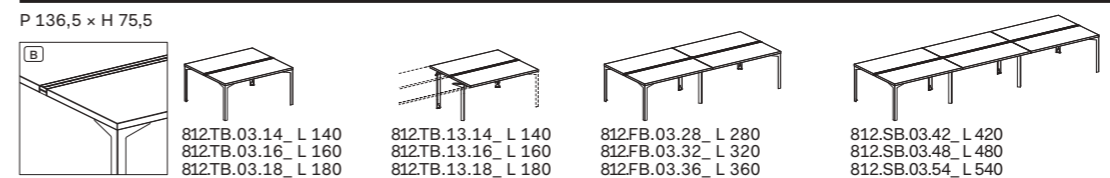

Tavoli scrivaniacon asole e 2 top access/Desks with opening and 2 top access

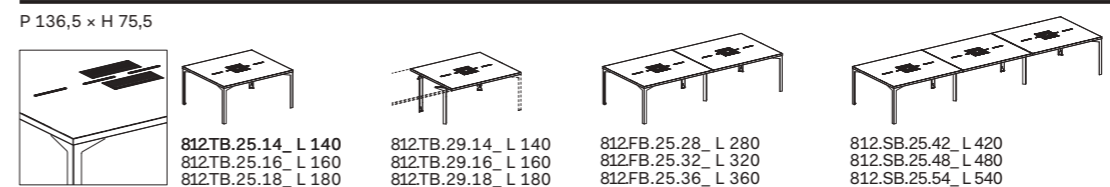

Note:

① Le dimensioni sono espresse in cm - consultare il listino prezzi per le caratteristiche tecniche, i codici degli articoli e delle finiture/Dimensions are stated in cm - for technical characteristics, article code numbers and finishing see price list;
 □ Con serratura/With lock;
 ⊠ I tavoli sono disponibili anche nella versione su ruote, consultare il listino per le varianti; / Tables are also available on wheels, see price list;

Piani di lavoro in melaminico sp. 38 mm con bordi perimetrali in ABS/Worktops in melamine 1 1/2" thick with perimetrical edges in ABS

Tavoli a 2 scrivanie contrapposte/Benches

P 160 - 160,3 - 166,5 x H 75,5

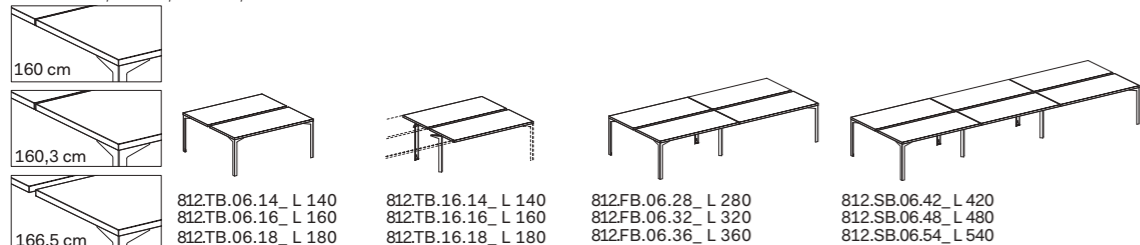

Tavoli a 2 scrivanie contrapposte + binario centrale/Benches + central rail

P 166,5 x H 75,5

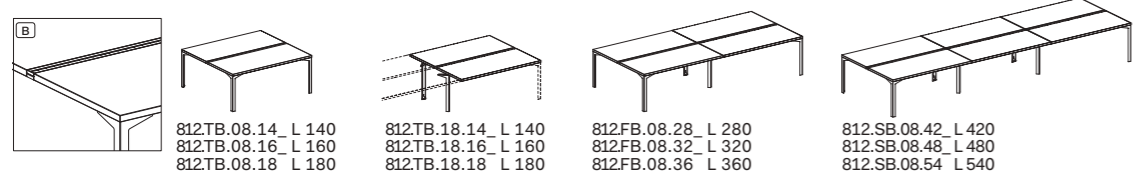

Tavoli scrivania per integrazioni /Integrable desks

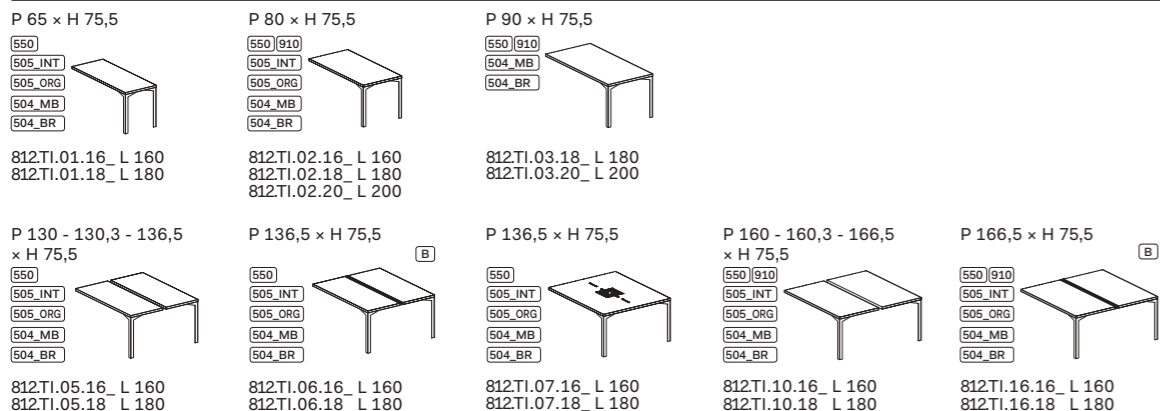

Note: Kit staffe da ordinare a parte, in base alla composizione da sviluppare / Brackets kit to be ordered separately, based on the composition to be developed

Tavoli sagomati integrabili su mobili di servizio/Integrable shaped desks for service units

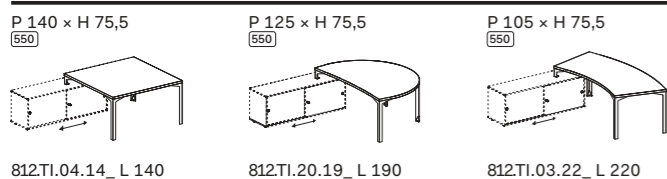

Note: Kit staffe per integrazione al mobile di servizio compreso nel codice / Brackets kit for integration to the service unit included in the code

Mobili di servizio con ante scorrevoli/Service units with sliding doors

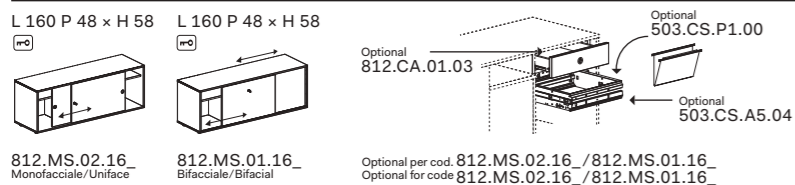

Kit supporto per fissaggio tavoli su mobile di servizio / Desk tables integration on service unit support kit

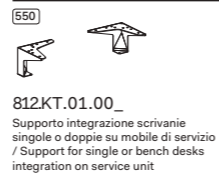

Note:

- Con serratura/With lock;
- Con binario centrale/With central rail;
- 550 Fissaggio su mobile di servizio / Service unit hooking;
- 910 Fissaggio su mobile multiuso DV910 / DV910 multipurpose unit hooking;
- 505_INT Fissaggio su contenitori DV505 / DV505 storage unit hooking;
- 505_ORG Fissaggio su orgatower DV505 / DV505 orgatower unit hooking;
- 504_MB Fissaggio su moduli base DV504 / DV504 base modules hooking;
- 504_BR Fissaggio su barra DV504 / DV504 metal bar hooking;

Piani di lavoro in melaminico sp. 38 mm con bordi perimetrali in ABS/Worktops in melamine 1 1/2" thick with perimetrical edges in ABS

Composizioni con tavoli integrabili su mobili di servizio/Compositions with integrable desks for service units 550

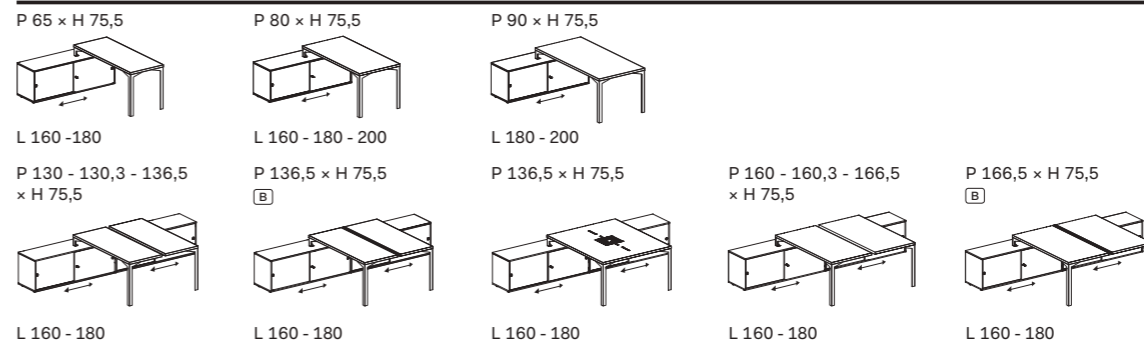

Note: Per le composizioni con tavoli scrivania su mobili di servizio ordinare sempre il kit Cod. 812.KT.01.00, il tavolo integrabile scelto e il mobile di servizio / For compositions with desk tables on service unit, always order the kit Cod. 812.KT.01.00, the chosen integrable table and the service unit

Kit supporto per fissaggio tavoli su mobile multifunzione DV910 / Desk tables integration on DV910 multi-purpose storage unit

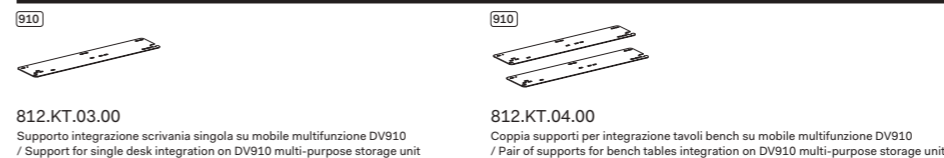

Composizioni con tavoli integrabili a mobile multifunzione DV910/Compositions with integrable desks on DV910 multi-purpose storage unit 910

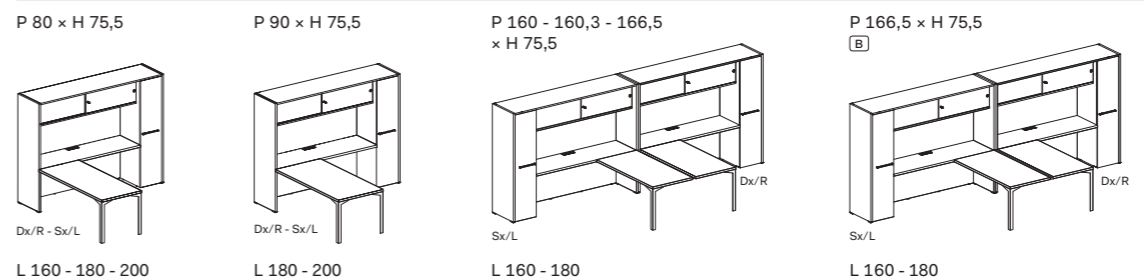

Note: Ordinare sempre il kit Cod. 812.KT.03.00 per i tavoli singoli e il kit Cod. 812.KT.04.00 per i tavoli bench / Always order the kit Cod. 812.KT.03.00 for single desk tables and the kit Cod. 812.KT.04.00 for bench tables. Ordinare a parte il mobile multifunzione e relativi accessori, consultare il listino DV910/Order the multifunctional storage unit and related accessories separately, see the DV910 price list

Kit supporto per fissaggio tavoli su contenitori integrati DV505 H= 75,5, 116,5, 166 / Desk tables on integrated storage unit DV505 H= 75,5, 116,5, 166

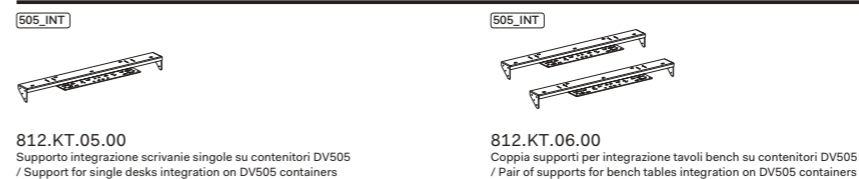

Composizioni con tavoli integrabili a contenitori DV505 H= 75,5, 116,5, 166 505_INT

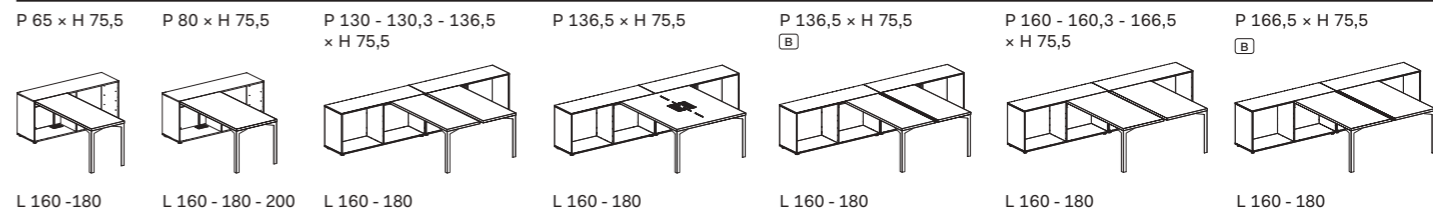



Note: Ordinare sempre il kit Cod. 812.KT.05.00 per i tavoli singoli e il kit Cod. 812.KT.06.00 per i tavoli bench / Always order the kit Cod. 812.KT.05.00 for single desk tables and the kit Cod. 812.KT.06.00 for bench tables. Ordinare a parte i moduli contenitori integrati H= 75,5, 116,5, 166 e relativi accessori, consultare il listino DV505/Order the H= 75,5 - 116,5 - 166 integrated storage unit and related accessories separately, see DV505 price list

Note:





- Le dimensioni sono espresse in cm - consultare il listino prezzi per le caratteristiche tecniche, i codici degli articoli e delle finiture/Dimensions are stated in cm - for technical characteristics, article code numbers and finishing see price list;
- Con binario centrale/With central rail;
- 550 Fissaggio su mobile di servizio / Service unit hooking;
- 910 Fissaggio su mobile multiuso DV910 / DV910 multipurpose unit hooking;
- 505_INT Fissaggio su contenitori DV505 / DV505 storage unit hooking;

Piani di lavoro in melaminico sp. 38 mm con bordi perimetrali in ABS/Worktops in melamine 1 1/2" thick with perimetrical edges in ABS

Kit supporto per fissaggio tavoli su orgatower H= 115 DV505 / Desk tables integration on orgatower H= 115 DV505 support kit

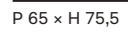
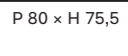
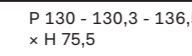
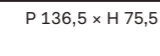
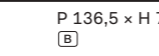
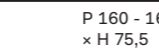

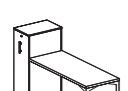
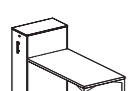
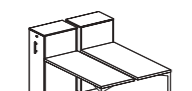
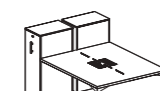
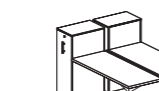
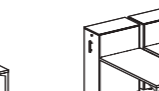
 <p>812.KT.07.00 Supporto integrazione scrivania singola su orgatower H= 115 DV505 / Support for single desk integration on orgatower H= 115 DV505</p>	 <p>812.KT.08.00 Coppia supporti per integrazione tavoli bench su orgatower H= 115 DV505 / Pair of supports for bench tables integration on orgatower H= 115 DV505</p>
---	--

Composizioni con tavoli integrabili a orgatower H= 115 DV505 / Compositions with integrable desks on orgatower H= 115 DV505

 <p>L 65 x H 75,5</p>	 <p>P 80 x H 75,5</p>	 <p>P 130 - 130,3 - 136,5 x H 75,5</p>	 <p>P 136,5 x H 75,5</p>	 <p>P 136,5 x H 75,5 (B)</p>	 <p>P 160 - 160,3 - 166,5 x H 75,5</p>	 <p>P 166,5 x H 75,5 (B)</p>
 <p>L 160 - 180</p>	 <p>L 160 - 180 - 200</p>	 <p>L 160 - 180</p>	 <p>L 160 - 180</p>	 <p>L 160 - 180</p>	 <p>L 160 - 180</p>	 <p>L 160 - 180</p>

Note: Ordinare sempre il kit Cod. 812.KT.07.00 per i tavoli singoli e il kit Cod. 812.KT.08.00 per i tavoli bench / Always order the kit Cod. 812.KT.07.00 for single desk tables and the kit Cod. 812.KT.08.00 for bench tables
Ordinare a parte gli orgatower H= 115 e relativi accessori, consultare il listino DV505/Order the H= 115 orgatower and related accessories separately, see DV505 price list

Kit supporto per fissaggio tavoli su moduli tecnici (DV504) / Desk tables integration on technical modules (DV504)

 <p>812.KT.09.00 Supporto integrazione scrivania singola su moduli tecnici (DV504) / Support for single desk integration on technical modules (DV504)</p>	 <p>812.KT.10.00 Coppia supporti per integrazione tavoli bench su moduli tecnici (DV504) / Pair of supports for bench tables integration on technical modules (DV504)</p>
--	---

Composizioni con tavoli integrabili su moduli tecnici (DV504)/Compositions with integrable desks on technical modules (DV504)

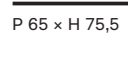
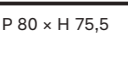
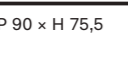
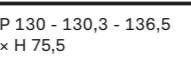
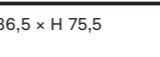
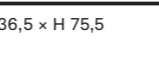
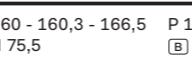
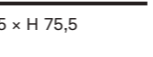
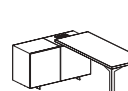
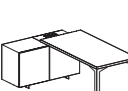
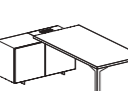
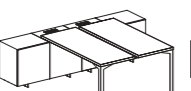
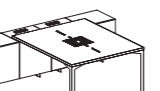
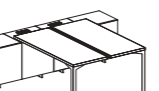
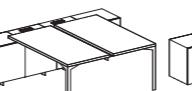
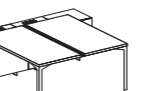



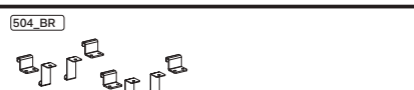

 <p>P 65 x H 75,5</p>	 <p>P 80 x H 75,5</p>	 <p>P 90 x H 75,5</p>	 <p>P 130 - 130,3 - 136,5 x H 75,5</p>	 <p>P 136,5 x H 75,5</p>	 <p>P 136,5 x H 75,5 (B)</p>	 <p>P 160 - 160,3 - 166,5 x H 75,5</p>	 <p>P 166,5 x H 75,5 (B)</p>
 <p>L 160 - 180</p>	 <p>L 160 - 180 - 200</p>	 <p>L 180 - 200</p>	 <p>L 160 - 180</p>	 <p>L 160 - 180</p>	 <p>L 160 - 180</p>	 <p>L 160 - 180</p>	 <p>L 160 - 180</p>

Note: Ordinare sempre il kit Cod. 812.KT.09.00 per i tavoli singoli e il kit Cod. 812.KT.10.00 per i tavoli bench / Always order the kit Cod. 812.KT.09.00 for single desk tables and the kit Cod. 812.KT.10.00 for bench tables
Ordinare a parte i moduli tecnici e i relativi accessori, consultare il listino DV504/Order the technical modules and related accessories separately, see DV504 price list

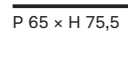
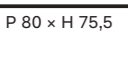
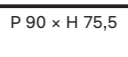
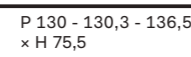
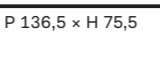
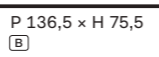
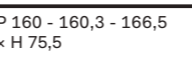
Kit supporto per fissaggio tavoli su barra (DV504)/ Desk tables integration on bar (DV504)

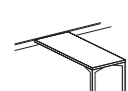
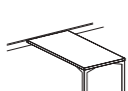
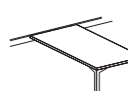
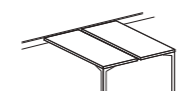
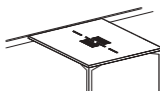
 <p>812.KT.11.00 Supporto integrazione scrivania singola su barra (DV504) / Support for single desk integration on bar (DV504)</p>	 <p>812.KT.12.00 Coppia supporti per integrazione tavoli bench su barra (DV504) / Pair of supports for bench tables integration on bar (DV504)</p>
---	--

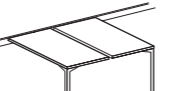
Composizioni con tavoli integrabili su barra (DV504)/Compositions with integrable desks on bar (DV504)

 <p>P 65 x H 75,5</p>	 <p>P 80 x H 75,5</p>	 <p>P 90 x H 75,5</p>	 <p>P 130 - 130,3 - 136,5 x H 75,5</p>	 <p>P 136,5 x H 75,5</p>	 <p>P 136,5 x H 75,5 (B)</p>	 <p>P 160 - 160,3 - 166,5 x H 75,5</p>	 <p>P 166,5 x H 75,5 (B)</p>
 <p>L 160 - 180</p>	 <p>L 160 - 180 - 200</p>	 <p>L 180 - 200</p>	 <p>L 160 - 180</p>	 <p>L 160 - 180</p>	 <p>L 160 - 180</p>	 <p>L 160 - 180</p>	 <p>L 160 - 180</p>

Note: Ordinare sempre il kit Cod. 812.KT.11.00 per i tavoli singoli e il kit Cod. 812.KT.12.00 per i tavoli bench / Always order the kit Cod. 812.KT.11.00 for single desk tables and the kit Cod. 812.KT.12.00 for bench tables
Ordinare a parte la barra a muro e i relativi accessori, consultare il listino DV504/Order the wall bar and related accessories separately, see DV504 price list

Note:

■ Prodotti non in pronta consegna. Per la disponibilità contattare l'ufficio commerciale/Items not in prompt delivery. Please contact the commercial department to check availability;

(B) Con binario centrale/With central rail;







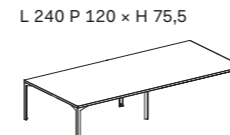
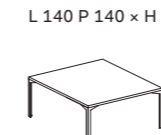
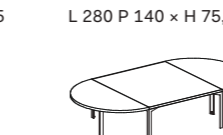
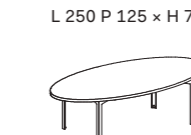

(505_ORG) Fissaggio su orgatower DV505 / DV505 orgatower unit hooking;

(504_MB) Fissaggio su moduli base DV504 / DV504 base modules hooking;

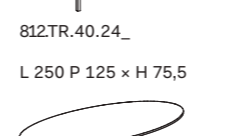
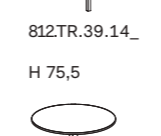
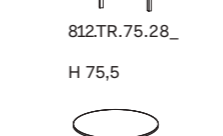
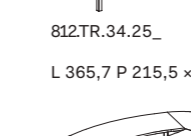
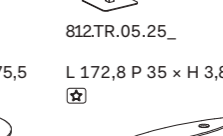
(504_BR) Fissaggio su barra DV504 / DV504 metal bar hooking;









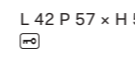
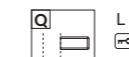

Piani di lavoro in melaminico sp. 38 mm con bordi perimetrali in ABS/Worktops in melamine 1 1/2" thick with perimetrical edges in ABS

Tavolo riunioni/Conference tables

 <p>L 240 P 120 x H 75,5</p>	 <p>L 140 P 140 x H 75,5</p>	 <p>L 280 P 140 x H 75,5</p>	 <p>L 250 P 125 x H 75,5</p>	 <p>L 250 P 125 x H 75,5</p>
 <p>L 250 P 125 x H 75,5</p>	 <p>H 75,5</p>	 <p>H 75,5</p>	 <p>L 365,7 P 215,5 x H 75,5</p>	 <p>L 172,8 P 35 x H 3,8</p>
 <p>812TR.04.25_</p>	 <p>812TR.11.10_ ø 100</p>	 <p>812TR.01.10_ ø 100</p>	 <p>812TR.75.36_</p>	 <p>812PR.75.17_</p>

⊠ Ordinare a parte due torrette elettrificate 300.AP.T._01 /Order two wired towers 300.AP.T._01 separately



Cassettiere/Pedestals

 <p>L 42 P 57 x H 55,5</p>	 <p>L 32,2 P 54,2 x H 55,5</p>	 <p>L 42,2 P 54,2 x H 55,5</p>	 <p>L 32,5 P 52 x H 14,5</p>
 <p>550.CS.10.04 Melaminico/Melamine</p>	 <p>550.CS.20.04 Melaminico/Melamine</p>	 <p>550.CS.1M.03 Metalliche/Metallic</p>	 <p>550.CS.2M.03 Metalliche/Metallic</p>
 <p>550.CS.1M.04 Metalliche - Vaschetta porta cancelleria inclusa/Metallic - Stationery tray included</p>	 <p>550.CS.2M.04 Metalliche - Vaschetta porta cancelleria inclusa/Metallic - Stationery tray included</p>	 <p>812.CA.01.05 Sospesa metallica /Hanged metallic</p>	

Note: Per portacancelleria cassette, vedi capitolo DV300-Accessori/For stationary tray, see chapter DV300-Accessories.

Note: Per portacancelleria cassette, vedi capitolo DV300-Accessori /For stationary tray, see chapter DV300-Accessories

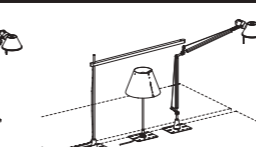
Accessori su binari/Accessories on rail

 <p>812.AB.01.00</p>	 <p>812.AB.01.01 Per bench P= 136,5 - 166,5 /For benches P= 136,5 - 166,5</p>	 <p>300.AC.15.06 Metallico/Metallic</p>
---	--	--

Modesty panels

 <p>P 1,8 x H35</p>	<p>812.MP.01.12_ L 87 812.MP.01.14_ L 107 812.MP.01.16_ L 127 812.MP.01.18_ L 147 812.MP.01.20_ L 167 Per tavoli/For desks</p>
--	--

Bracci porta video/Arms for video support

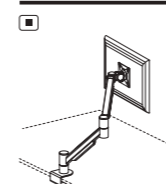
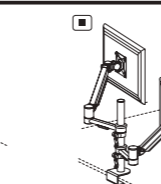
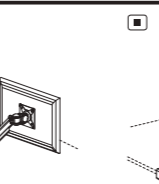
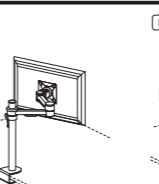
 <p>300.AC.02.01 Braccio porta video mobile su piano /Dynamic arm for video support on deskbase</p>	 <p>300.AC.02.02 Doppio braccio porta video mobile su piano/2 dynamic arms for video support on deskbase</p>	 <p>300.AC.01.01 Braccio porta video statico su palo/Static arm for video support on pole</p>	 <p>300.AC.01.02 Doppio braccio porta video statico su palo/2 static arms for video support on pole</p>
--	---	--	--

Note:

Ⓜ Le dimensioni sono espresse in cm - consultare il listino prezzi per le caratteristiche tecniche, i codici degli articoli e delle finiture/Dimensions are stated in cm - for technical characteristics, article code numbers and finishing see price list;

■ Prodotti non in pronta consegna. Per la disponibilità contattare l'ufficio commerciale/Items not in prompt delivery. Please contact the commercial department to check availability;

⊠ Con serratura/With lock;

Frontal panels Sp. 0,8 - 1

P 1 x H 39

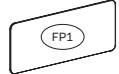

FP1

P 0,8 x H 39



FP08

300.FP.06.06 L 64
300.FP.06.07 L 79
300.FP.06.09 L 99
300.FP.06.11 L 119
300.FP.06.13 L 139
300.FP.06.15 L 159
300.FP.06.17 L 179
300.FP.06.19 L 199

Melaminico/Melamine

300.FPV1.06 L 64
300.FPV1.07 L 79
300.FPV1.09 L 99
300.FPV1.11 L 119
300.FPV1.13 L 139
300.FPV1.15 L 159
300.FPV1.17 L 179
300.FPV1.19 L 199

Vetro/Glass

Frontal panel fonoassorbenti Sp. 3/ Acoustic frontals panels T. 3

P 3 x H 39

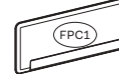

FPC1

P 3 x H 59



FPC2

300.FP.40.06 L 64
300.FP.40.07 L 79
300.FP.40.09 L 99
300.FP.40.11 L 119
300.FP.40.13 L 139
300.FP.40.15 L 159
300.FP.40.17 L 179
300.FPV1.19 L 199

Tessuto/Fabric

Frontal panels H 65

P 1 x H 65



FP65

P 0,5 x H 65



FPP

300.FP.09.06 L 64
300.FP.09.07 L 79
300.FP.09.09 L 99
300.FP.09.11 L 119
300.FP.09.13 L 139
300.FP.09.15 L 159
300.FP.09.17 L 179
300.FP.09.19 L 199

Melaminico/Melamine

300.FP.69.06 L 64
300.FP.69.11 L 119
300.FP.69.13 L 139
300.FP.69.15 L 159

Plexiglass

Staffe e supporti per frontal panels Sp. 0,5 - 0,8 - 1 - 3 / Brackets and clamps for frontal panels T. 0,5 - 0,8 - 1 - 3

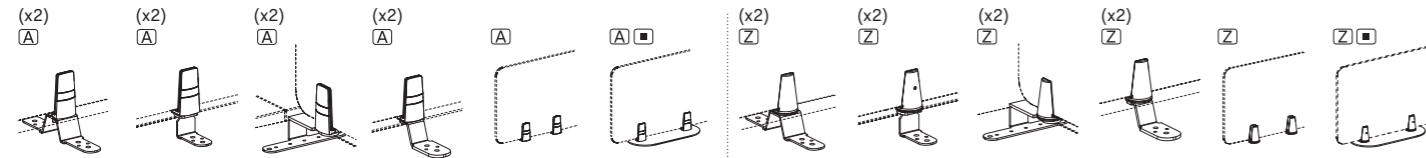

812.FP.91.01 Supporto per bench P=136,5 - 166,5 / Bracket for bench D= 136,5 - 166,5

812.FP.91.02 Supporto per bench P=130,3 - 160,3 / Bracket for bench D= 130,3 - 160,3

812.FP.91.03 Supporto per piani / Bracket for worktops

812.FP.91.04 Supporto inclinato per piani / Inclined bracket for worktops

300.FP.28.00 Per piani-binari / For worktops -tracks

300.FP.33.00 Free standing per piani / Free standing for worktops

812.FP.91.01 Supporto per bench P=136,5 - 166,5 / Bracket for bench D= 136,5 - 166,5

812.FP.91.02 Supporto per bench P=130,3 - 160,3 / Bracket for bench D= 130,3 - 160,3

812.FP.91.03 Supporto per piani / Bracket for worktops

812.FP.91.04 Supporto inclinato per piani / Inclined bracket for worktops

300.FP.22.00 Per piani-binari / For worktops -track

300.FP.33.00 Free standing per piani / Free standing for worktops

Per frontal panels/For frontal panels

Accessori per frontal panels in melaminico/Accessories for melamine frontal panels

L 6,5 P 6,5 x H 8,5

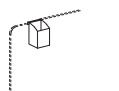

300.FA.01.01

L 50 P 17 x H 3

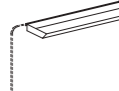

300.FA.02.05

L 31 P 22 x H 5

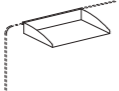

300.FA.04.03

L 23 P 10 x H 29

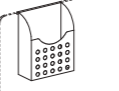

300.FA.06.02

L 35 P 6,5 x H 30

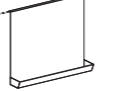

300.FA.08.03

Note: Il posizionamento degli accessori sui frontal panel in vetro prevede l'utilizzo di una guarnizione in PVC trasparente (Optional su richiesta)/Placement of accessories on glass front panel need the use of a transparent PVC gasket (Optional on request)
Non utilizzabile su frontal panels in plexiglass e frontal panels in tessuto fonoassorbente / Not usable for plexiglass frontal panels and acoustic frontal panels

Frontal panel speciale / Special frontal panel

P 3



FPS

300.FR.10.08 L 80 x H 30
300.FP.60.14 L 140 x H 42,5

Supporti per frontal panel speciali / Bracket for special frontal panels

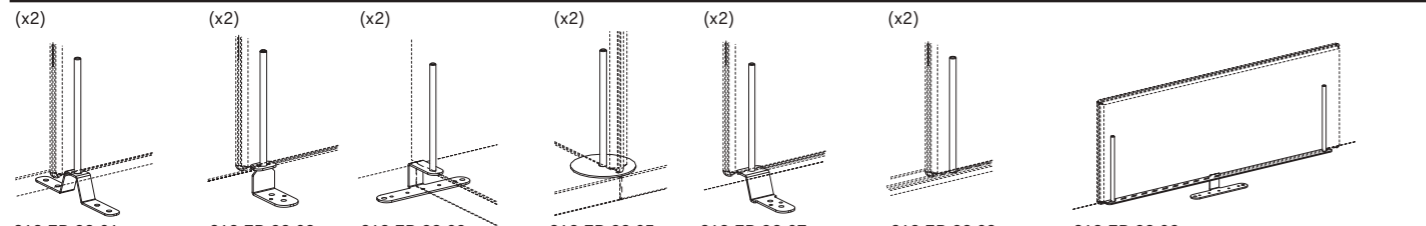

812.FP.92.01 Supporto frontal speciali per bench P=136,5 - 166,5 / Special frontal panels bracket for bench D= 136,5 - 166,5

812.FP.92.02 Supporto frontal speciali per bench P=130,3 - 160,3 / Special frontal panels bracket for bench D= 130,3 - 160,3

812.FP.92.03 Supporto per frontal panel speciali / Bracket for special frontal panels

812.FP.92.05 Supporto "flessibile" per frontal panel speciali / "Flexible" bracket for special frontal panels

812.FP.92.07 Supporto inclinato frontal panel speciali / Inclined bracket for special frontal panels

812.FP.92.08 Supporto per binario frontal panel speciali / bracket for central rail for special frontal panels

812.FP.92.06 Supporto per frontal panel speciale L=80 / Bracket for special frontal panel W=80

Per frontal panels/For frontal panels

Note:

1 Le dimensioni sono espresse in cm - consultare il listino prezzi per le caratteristiche tecniche, i codici degli articoli e delle finiture/Dimensions are stated in cm - for technical characteristics, article code numbers and finishing see price list;

2 Prodotti non in pronta consegna. Per la disponibilità contattare l'ufficio commerciale/Items not in prompt delivery. Please contact the commercial department to check availability;

V Vetro/Glass; P Plexiglass

A Morsetti o supporti in ABS /ABS clamps

Z Morsetti o supporti in ZAMA / Zamak clamps

Canalizzazione - Elettrificazione - Accessori/Wire management - Electrification - Accessories

300.AP.T2.01 Ø 8



812.AP.01.08 L 80
812.AP.01.10 L 100
812.AP.01.12 L 120
812.AP.01.14 L 140
812.AP.01.16 L 160

812.AP.02.08 L 80
812.AP.02.10 L 100
812.AP.02.12 L 120
812.AP.02.14 L 140

812.AP.04.01

812.AP.03.01

300.AP.20.00

300.AP.V1.00

300.AP.F1.00

300.AP.T8.01 Ø 8

L 32 x P 12,3

300.AC.26.02 L 24,5
300.AC.26.03 L 34,5
300.AC.26.04 L 44,5

300.AC.20.02 L 24,5
300.AC.20.03 L 34,5
300.AC.20.04 L 44,5

300.AC.25.02 L 23,5
300.AC.25.03 L 33,5
300.AC.25.04 L 43,5

Marsupio/Basket

300.APS1.02 L 20,5
300.APS1.03 L 30
300.APS1.04 L 42

Per/For top access 300.AC.26...

300.AC.38.03_H 3

300.AC.67.03
Marsupio per top access 300.AC.38.03 / Basket for top access 300.AC.38.03

300.AT.A6.02 L 21
300.AT.A6.03 L 25,5
300.AT.A6.04 L 39

300.APT.4.01
300.APT.5.01 - UK
300.APT.6.01 - US

300.AC.16.02

300.AC.06.05

812.AC.06.00
Cinghie porta Cpu /Cpu holder straps

812.AC.01.00
Staffa e cinghie porta Cpu /Bracket and cpu holder straps

L 6,6 P 1,7 x H 63

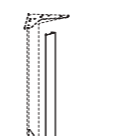

812.AP.08.00
Carter gamba /Carter leg

L 6,6 P 1,7 x H 59

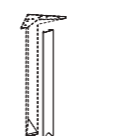

812.AP.08.03
Carter gamba con ruota /Carter for leg with wheel

L 6,6 P 1,7 x H 94

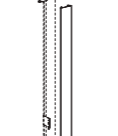

812.AP.08.05
Carter gamba tavoli alti /Carter for high tables leg

L 6,6 P 1,7 x H 5,5



812.AP.08.07
Carter per supporto per mobile di servizio /Carter for service unit support

L 13 P 6,2 x H 0,5

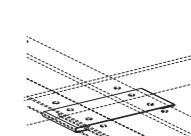

812.AC.07.01
Carter per omega bench /Carter for bench's omega

812.GC.01.05
Coppia carter per gamba intermedia P= 130 / 130,3 / 136,5 / 160 / 160,3 / 166,5 / Pair of casings for middle leg D= 130 / 130,3 / 136,5 / 160 / 160,3 / 166,5

Ø 8



300.AP.T8.11
Tappo con 1 presa elettrica + USB (solo ricarica) + passacavo / Plug with 1 electrical socket + USB (only charge) + outlet lid



300.AP.T8.14
Tappo con 1 presa elettrica + USB (solo ricarica) + HDMI / Plug with 1 electrical socket + USB (only charge) + HDMI



300.AP.T8.17
Tappo con 1 presa elettrica + USB (solo ricarica) + RJ45 / Plug with 1 electrical socket + USB (only charge) + RJ45



300.AP.T8.20
Tappo con 1 presa elettrica + USB (solo ricarica) + USB dati / Plug with 1 electrical socket + USB (only charge) + USB data

L 5 P 3 x H 5



812.AC.08.01
812.AC.08.01 - UK
812.AC.08.01 - US
Presa USB (solo ricarica) / USB Socket (only charge)

Note:

1 Le dimensioni sono espresse in cm - consultare il listino prezzi per le caratteristiche tecniche, i codici degli articoli e delle finiture/Dimensions are stated in cm - for technical characteristics, article code numbers and finishing see price list;

2 Per la scelta dei contenitori e degli accessori vari, consultare il relativo listino o catalogo/To choose storage units and accessories, please check correspondent price list or catalogue;

3 Le finiture in melaminico effetto pelle non sono in pronta consegna. Per la disponibilità contattare l'ufficio commerciale/Items not in prompt delivery. Please contact the commercial department to check availability;

Fino ad esaurimento/Until exhaustion;

4 Prodotti non in pronta consegna. Per la disponibilità contattare l'ufficio commerciale/Items not in prompt delivery. Please contact the commercial department to check availability;

5 Articoli prodotti solo su richiesta/Items produced only on demand;

Nida

DV816

Eleganti e colorati, questi scrittoi si distinguono per stile, leggerezza e contemporaneità. Dedicati e creati soprattutto per l'home office, essi sono estremamente funzionali, si montano con facilità e sono disponibili con gambe in tubolare metallico oppure coniche in legno.

Elegant and colorful, these desks stand out for their style, lightness and contemporaneity. Dedicated and created especially for the home office, they are extremely functional, are easy to assemble and are available with metal tubular or conical wooden legs.



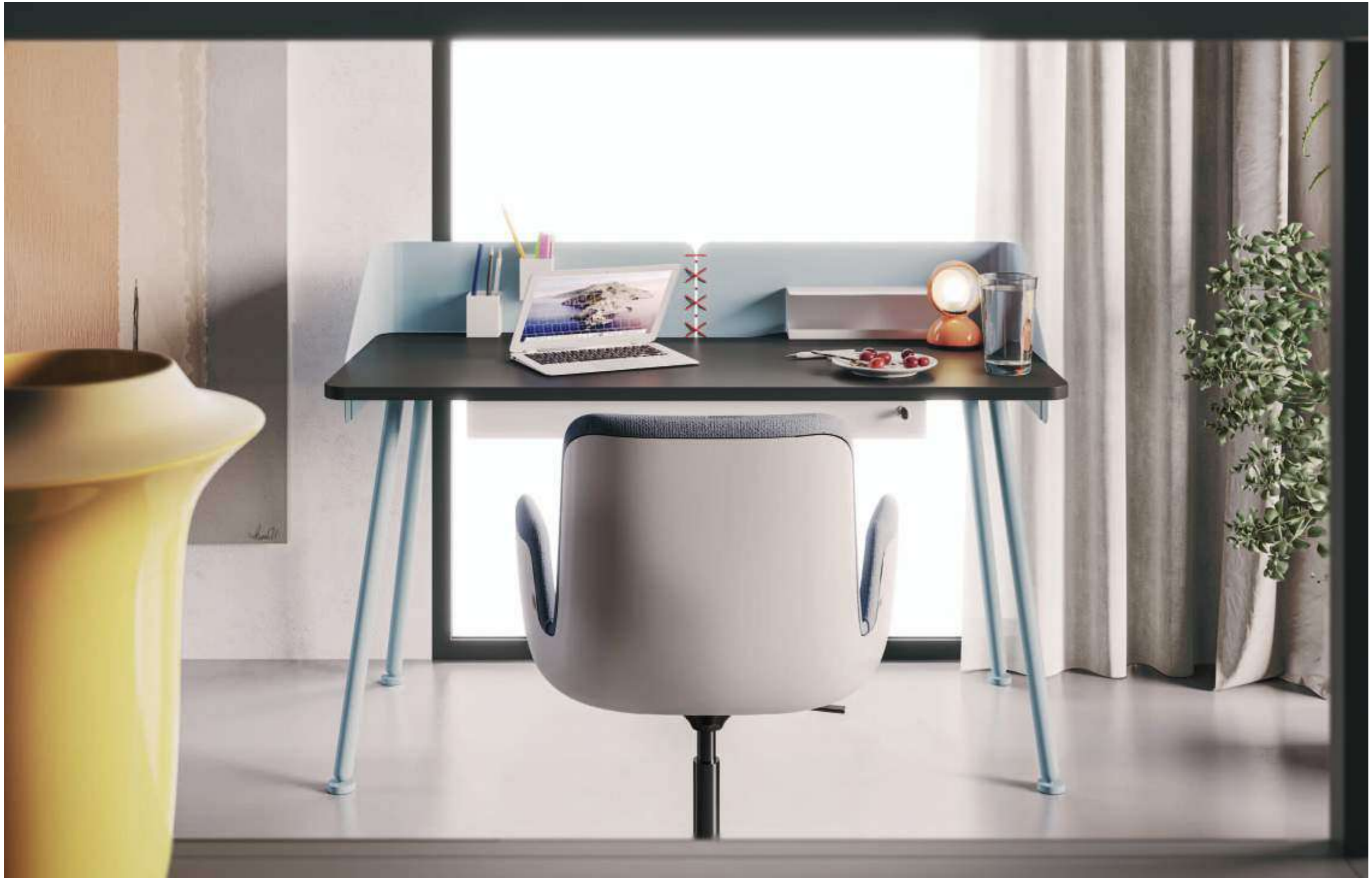

Nella versione più completa, si possono aggiungere due carter frontali in lamiera verniciata; questi, oltre a contenere i cablaggi, si legano tra di loro mediante cordoncino elastico di colore rosso che diventa un dettaglio estetico riconoscibile.



In the more complete version it is possible to add two front guards in painted sheet metal; these, in addition to containing the wiring, are linked together by means of a red elastic cord which becomes a recognizable aesthetic detail.

Tavoli / Tables

Plani di lavoro sp. 2,5 cm, in melaminico con bordi in ABS sp. 0,2 cm / Worktops 2,5 cm thick, in melamine with ABS edge-profiles 0,2 cm thick



Strutture e schermi in metallo / Metal structures and screens

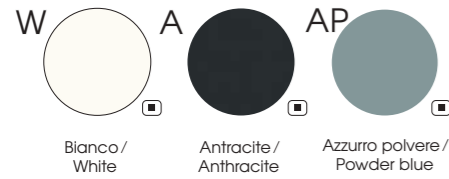

Gambe in legno/Wooden legs



Cassetti metallici e accessori/Metal drawers and accessories



Cordoncino elastico/Elastic cord



Note

Per i colori e le finiture dei Frontal Panels, vedere il relativo capitolo in DV300 - Accessori. / For colours and finishes of Frontal Panels, see the chapter in DV300 - Accessories.
 ■ Prodotti non in pronta consegna. Per la disponibilità contattare l'ufficio commerciale. / Items not in prompt delivery. Please contact the commercial department to check availability.

Plani di lavoro in melaminico sp. 25 mm con bordi perimetrali in ABS / Worktops in melamine 25 mm thick with perimetrical edges in ABS

Tavoli scrivania home office / Home office desks

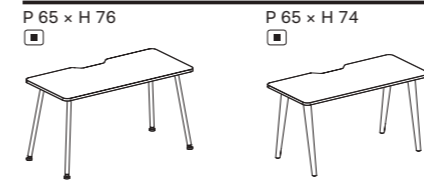

816.TS.01.14_ L 140
Con gambe metalliche / With metal legs
816.TS.01.14_ L 140
Con gambe coniche in legno / With wooden conic legs

Tavoli scrivanie home office con schermi metallici / Home office desks with metal screens

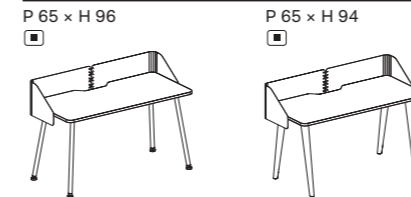

816.TS.91.14_ L 140
Con gambe metalliche / With metal legs
816.TS.91.14_ L 140
Con gambe coniche in legno / With wooden conic legs

Accessori per piano / Accessories for worktop

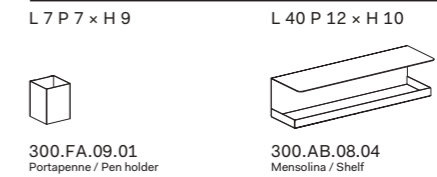

300.FA.09.01
Portapenne / Pen holder

300.AB.08.04
Mensolina / Shelf

Cassettiere/Pedestals

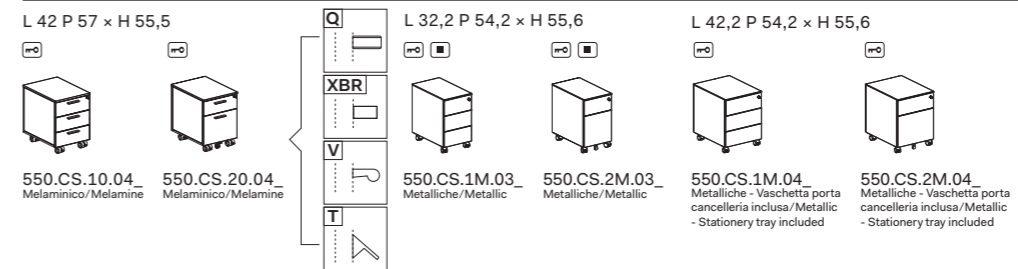

Note: Per portacancelleria cassetti, vedi capitolo DV300-Accessori / For stationary tray, see chapter DV300-Accessories.

Cassetti metallici / Metallic drawer

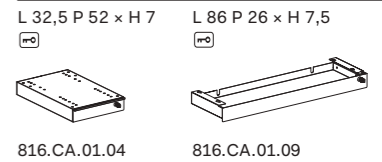

816.CA.01.04

816.CA.01.09

Morsetti e supporti per frontal panels sp. 3 - sp. 1 - sp. 0,8 / Clamps for frontal panels t. 3 - t. 1 - t. 0,8

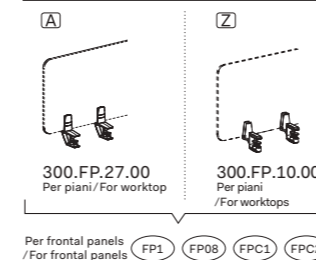

300.FP.27.00 Per piani / For worktop
300.FP.10.00 Per piani / For worktops

Frontal panels sp. 1 - sp. 0,8

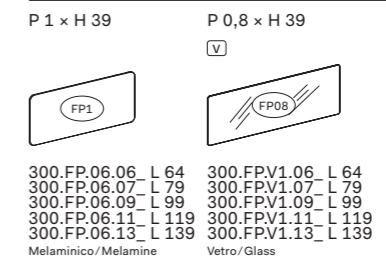

300.FP.06.06 L 64
300.FP.06.07 L 79
300.FP.06.09 L 99
300.FP.06.11 L 119
300.FP.06.13 L 139
300.FPV1.06 L 64
300.FPV1.07 L 79
300.FPV1.09 L 99
300.FPV1.11 L 119
300.FPV1.13 L 139
Melaminico / Melamine
Vetro / Glass

Frontal panel fonoassorbenti sp. 3 / Acoustic frontals panels t. 3

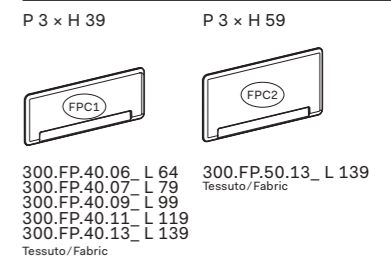

300.FP.40.06 L 64
300.FP.40.07 L 79
300.FP.40.09 L 99
300.FP.40.11 L 119
300.FP.40.13 L 139
Tessuto / Fabric
300.FP.50.13 L 139
Tessuto / Fabric

Canalizzazione - Elettrificazione - Accessori / Wire management - Electrification - Accessories

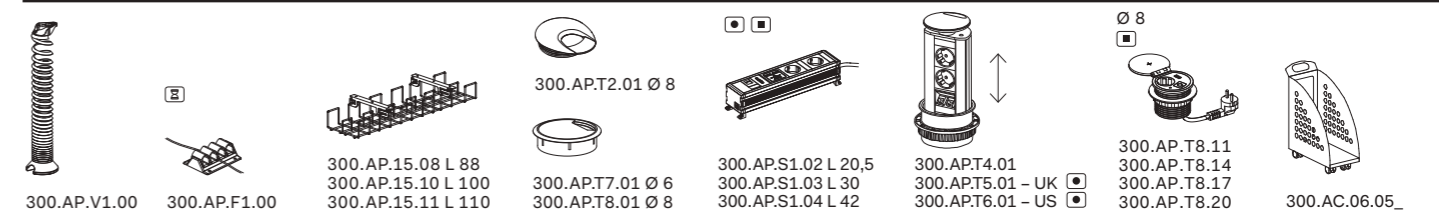

Note:

- 1 Le dimensioni sono espresse in cm - consultare il listino prezzi per le caratteristiche tecniche, i codici degli articoli e delle finiture / Dimensions are stated in cm - for technical characteristics, article code numbers and finishing see price list;
- 2 Per la scelta dei contenitori e degli accessori vari, consultare il relativo listino o catalogo / To choose storage units and accessories, please check correspondent price list or catalogue;
- Prodotti non in pronta consegna. Per la disponibilità contattare l'ufficio commerciale / Items not in prompt delivery. Please contact the commercial department to check availability;
- Con serratura / With lock.
- Articoli prodotti solo su richiesta / Items produced only on demand;
- ∇ Vetro / Glass.
- ▲ Morsetti o supporti in ABS / ABS clamps
- Ⓩ Morsetti o supporti in ZAMA / Zamak clamps
- Ⓜ Fino ad esaurimento / Until exhaustion;

Modules System

Design di tendenza,
semplicità, praticità di
integrazione con tutte
le nostre serie a
catalogo e facilità
di utilizzo.

*Trendy design,
simplicity, integration
possibility to all series
in our catalogue
and easy use.*

E-Media P. 326



E-Media DV401

Il modulo d'arredo multimediale destinato alla videocomunicazione, alle sale conferenza, alle aree meeting e al lavoro di gruppo; nasce per soddisfare l'esigenza di comunicare e di far interagire più persone contemporaneamente, anche in sedi diverse.

The multimedia furniture module intended video communication, conference rooms, meeting areas and group work; was created to meet the need to communicate and interact with several people at the same time, even in different locations.







Non più il classico arredo ufficio ma un singolo modulo d'arredo per l'area lavoro o l'home office che permette di creare una mini isola operativa molto interessante sia dal punto di vista funzionale sia estetico.

No longer the classic office furniture but a single furniture module for the work area or home office that allows you to create a very interesting mini operating island from both a functional and aesthetic point of view.



"Sitting"

"Standing"

Sistema moduli / Modules system

Piani di lavoro, schiene e basamenti sottopiano sp. 2.5 cm in melaminico / Worktops, backs and undertop pedestal 2.5 cm thick in melamine



Staffa - Carter - Vassio / Brackets - Casing - Tray



E-Media – Dispositivo multimediale / Multi-Media – Device

P 160 x H 174

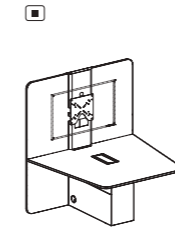

401.SM.01.14_L 142,5
401.SM.01.20_L 202,5

P 160 x H 207

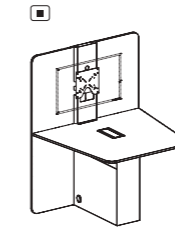

401.SM.02.14_L 142,5
401.SM.02.20_L 202,5

Canalizzazione / Wire-management

P 61,5 x H 29,3

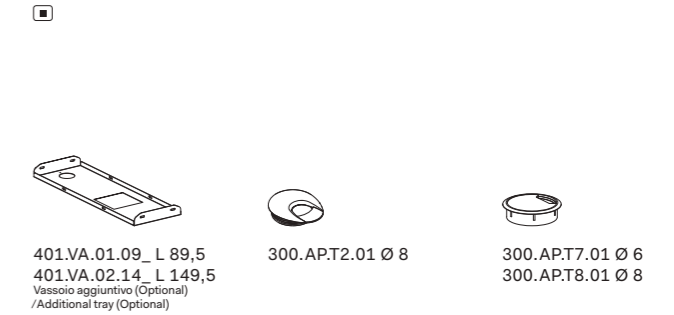

Canalizzazione – Elettrificazione – Accessori / Wire-management – Electrification – Accessories

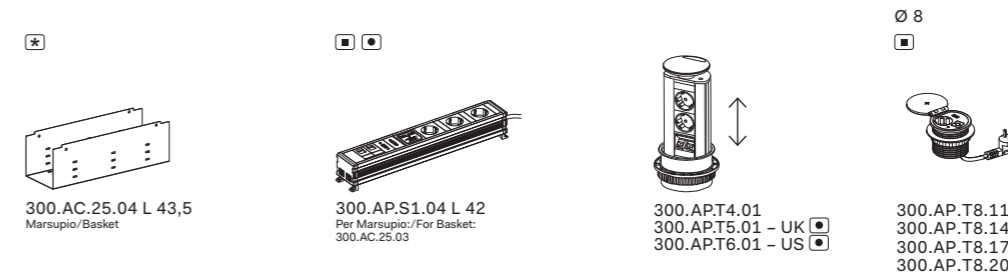

Note

Per altri accessori, consultare il relativo listino prezzi / For other accessories, see the relative price list.

Note:

- 1 Su richiesta Hardware e software. Possibilità di montare il monitor fornito dal cliente / Hardware and software on demand. Possibility to mount the monitor provided by the customer;
- 2 Per la scelta degli accessori vari, consultare il relativo listino o catalogo / To choose accessories, please check correspondent price list or catalogue;
- 3 Le dimensioni sono espresse in cm – consultare il listino prezzi per le caratteristiche tecniche, i codici degli articoli e delle finiture / Dimensions are stated in cm – for technical characteristics, article code numbers and finishing see price list.
- 4 Tutti gli articoli della serie DV401 - E-MEDIA non sono in pronta consegna. Per la disponibilità contattare l'ufficio commerciale / All the items of the DV401 - E-MEDIA series are not in prompt delivery. Please contact the commercial department to check availability
- 5 Articoli prodotti solo su richiesta / Items produced only on demand
- 6 Fino ad esaurimento / Until exhaustion;
- 7 Per Top access: / For Top access: 300.AC.20.04

Home Office Solutions

Living, smart solutions, safety, sustainability, resimercial design sono solo alcune delle parole chiave che muovono le proposte all'interno di questo catalogo dove i prodotti progettano ambienti. Il connubio tra materiali, colori e finiture crea linguaggi stilistici trasversali in grado di adattarsi ai contesti e agli stili di interior design più disparati apportando nuove funzionalità e un rinnovato appeal alle nostre case e ai nostri uffici.

Living, smart solutions, safety, sustainability, resimercial design are just some of the keywords that recap the proposals within this catalogue where products design environments. The combination of materials, colours and finishes creates transversal stylistic languages able to adapt to the most different contexts and interior design styles, bringing new features and a renewed appeal to our homes and offices.











Abbiamo progettato
arredi e sistemi
che consentano di
soddisfare le nostre
esigenze concependo
lo spazio di lavoro
in maniera smart in
qualsiasi ambiente.



*We have designed
furnishings and
systems that allow
us to meet our needs
by conceiving the
workspace in a
smart way in any
environment.*

Meet DV990

Eleganti geometrie compositive, disegnano svariati e molteplici tavoli riunioni, così da poter arredare con funzionalità e prestigio qualsiasi ambiente di lavoro che necessiti di professionalità e comfort.

Elegant compositional geometries draw a variety of meeting tables, so to furnish with functionality and prestige any meeting place that requires professionalism and comfort.

Special tables P. 350



Special tables

Una linea di tavoli riunione "speciali" che arricchisce e valorizza la gamma già esistente di tavoli, nelle nostre molteplici collezioni.

A line of "special" meeting tables which enriches the range of the existing ones, in our numerous collections.

























Tavoli / Tables **990.TR.C0.1A**

Piani di lavoro sp. 2.5 cm, in melaminico o laminato (☒) con bordi in ABS sp. 0.2 cm / Worktops and legs 2.5 cm thick, in melamine or laminate (☒) with ABS edge-profiles 0.2 cm

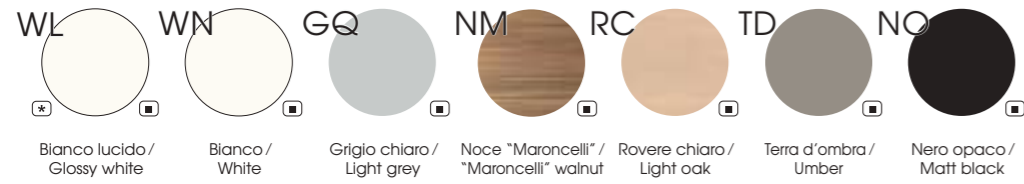

Gambe in metallo / Metal legs

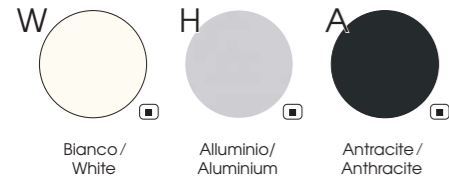

Tavoli / Tables **990.TR.C0.2A - 990.TR.C0.5A - 990.TR.C0.6C - 990.TR.C0.6D**

Piani di lavoro e gambe sp. 3.8 cm, in melaminico con bordi in ABS sp. 0.2 cm / Worktops and legs 3.8 cm thick in melamine with ABS edge-profiles 0.2 cm thick
Schiene sp.1.8 cm, in melaminico / Back panels 1.8 cm thick, in melamine



Top access in alluminio / Aluminium Top access

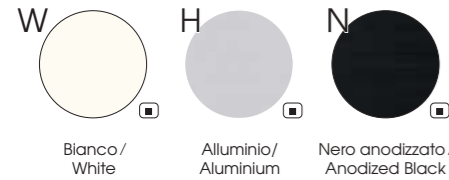

Tavoli / Tables **990.TR.C0.3A**

Piani di lavoro sp. 2.5 cm, in melaminico o laminato (☒) con bordi in ABS sp. 0.2 cm / Worktops and legs 2.5 cm thick, in melamine or laminate (☒) with ABS edge-profiles 0.2 cm
Schiene sp.1.8 cm, in melaminico o laminato (☒) / Back panels 1.8 cm thick, in melamine or laminate (☒)

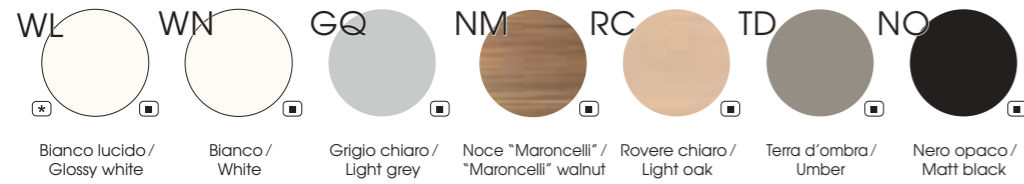

Gambe in metallo / Metal legs

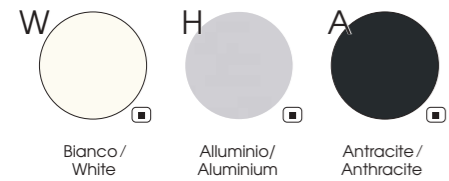

Note

☒ Prodotti non in pronta consegna. Per la disponibilità contattare l'ufficio commerciale / Items not in prompt delivery. Please contact the commercial department to check availability.

Tavoli / Tables **990.TR.C0.4A**

Piani di lavoro e gambe sp. 3.8 cm, in melaminico con bordi in ABS sp. 0.2 cm / Worktops and legs 3.8 cm thick in melamine with ABS edge-profiles 0.2 cm thick
Schiene sp. 1.8 cm, in melaminico / Back panels 1.8 cm thick, in melamine
Piano centrale con top access sp. 1.8 cm, in melaminico / Central worktops with top access 1.8 cm thick, in melamine



Top access in alluminio / Aluminium Top access

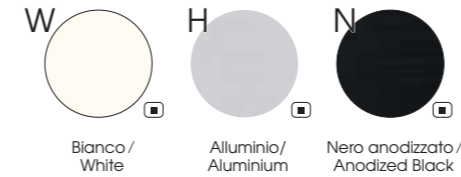

Tavoli / Tables **990.TR.C0.7A**

Piani di lavoro sp. 2.5 cm, in melaminico o laminato (☒) con bordi in ABS sp. 0.2 cm / Worktops and legs 2.5 cm thick, in melamine or laminate (☒) with ABS edge-profiles 0.2 cm
Piano centrale con top access sp. 1.8 cm, in melaminico o laminato (☒) / Central worktops with top access 1.8 cm thick, in melamine or laminate (☒)

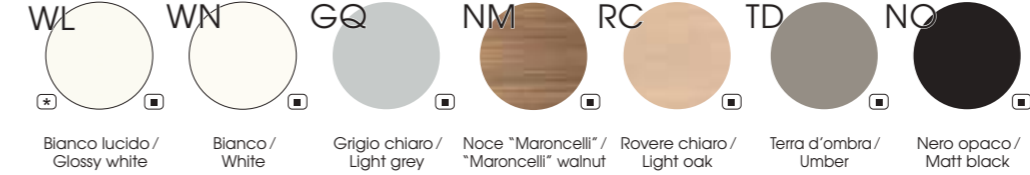

Gambe in metallo / Metal legs

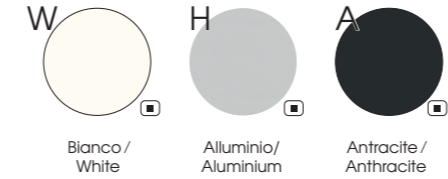

Top access in alluminio / Aluminium Top access

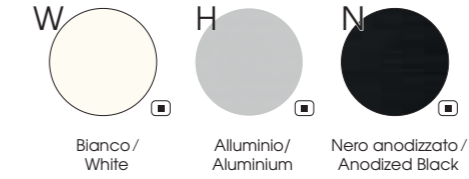

Tavoli / Tables **990.TR.C0.8A - 990.TR.C0.8B**

Piani di lavoro sp. 2.5 cm, in melaminico con bordi in ABS sp. 0.2 cm / Worktops and legs 2.5 cm thick, in melamine with ABS edge-profiles 0.2 cm



Gambe in metallo / Metal legs

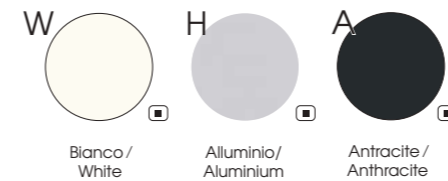

Modesty panel in tessuto tecnico / Technical fabric modesty panel

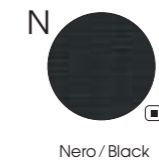

Note

☒ Prodotti non in pronta consegna. Per la disponibilità contattare l'ufficio commerciale / Items not in prompt delivery. Please contact the commercial department to check availability.

Tavoli / Tables **990.TR.C0.9A**

Piani di lavoro sp. 2.5 cm, in melaminico o laminato (☒) con bordi in ABS sp. 0.2 cm / Worktops and legs 2.5 cm thick, in melamine or laminate (☒) with ABS edge-profiles 0.2 cm
 Schiene sp.1.8 cm, in melaminico o laminato (☒) / Back panels 1.8 cm thick, in melamine or laminate (☒)



Gambe in metallo / Metal legs

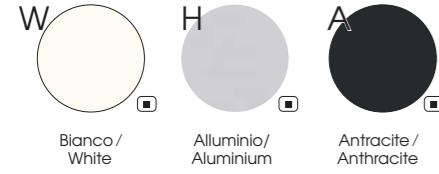

Top access in alluminio / Aluminium Top access

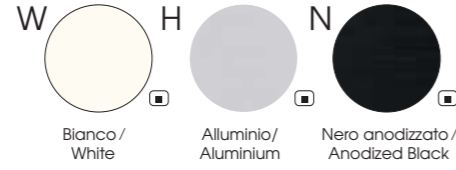

Tavoli / Tables **990.TR.C1.0A - 990.TR.C1.0B - 990.TR.C1.0C - 990.TR.C1.1A - 990.TR.C1.1B**

Piani di lavoro sp. 3.8 cm, in melaminico con bordi in ABS sp. 0.2 cm / Worktops and legs 3.8 cm thick, in melamine with ABS edge-profiles 0.2 cm thick
 Colonne sp. 2.5 cm, in melaminico / Columns 2.5 cm thick, in melamine



Top access in alluminio / Aluminium Top access

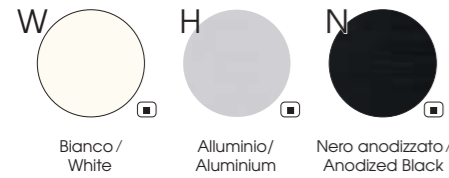

Note

☒ Prodotti non in pronta consegna. Per la disponibilità contattare l'ufficio commerciale / Items not in prompt delivery. Please contact the commercial department to check availability.

Tavoli riunione speciali / Special meeting tables

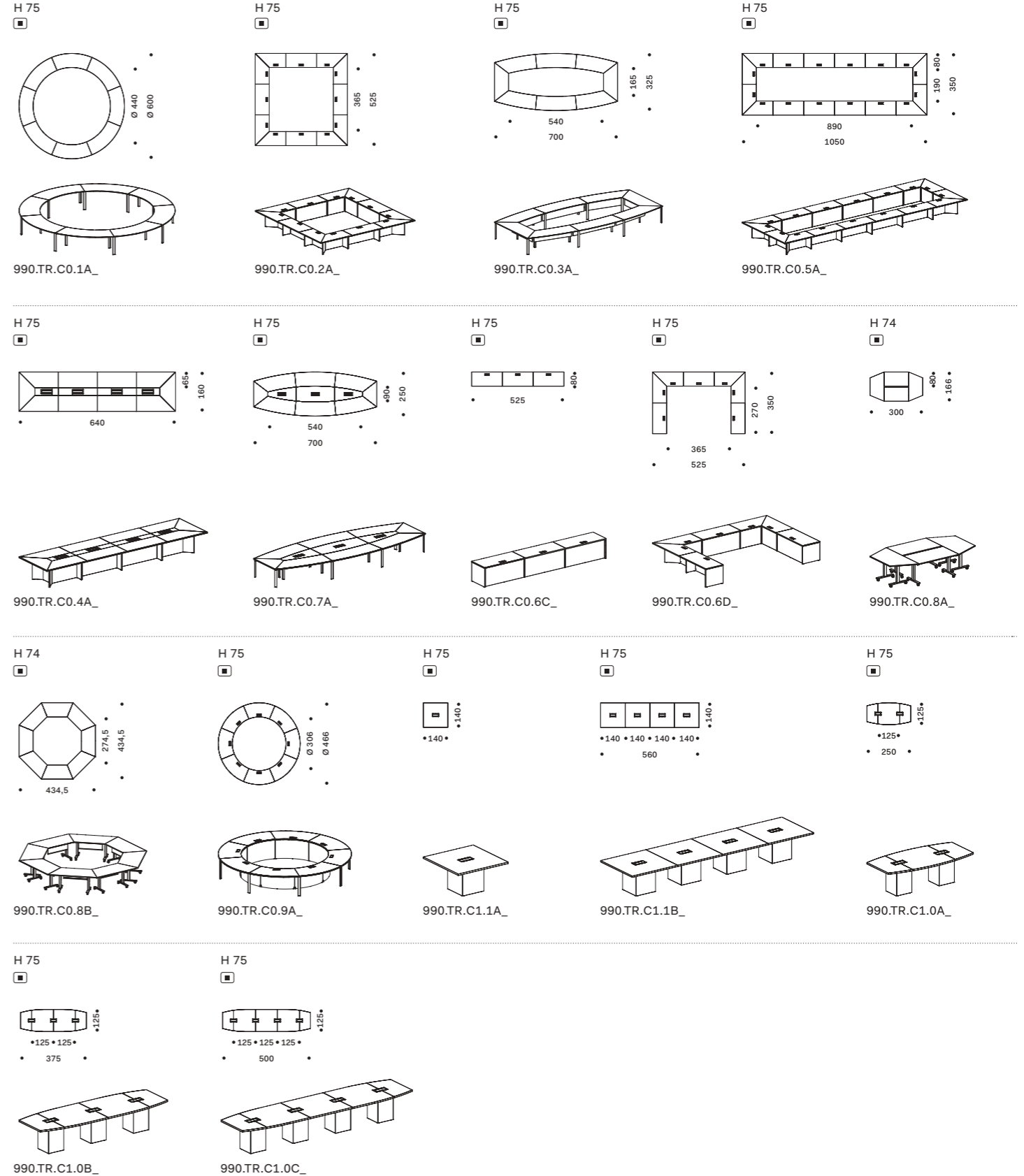

Note:

☒ Le versioni dei tavoli riunione "speciali", fotografati con microfoni e monitor integrati, non sono disponibili a listino. Per eventuali richieste contattare l'ufficio commerciale / The "special" meeting tables, photographed with incorporated microphones and monitors, are not available in our price list. Please contact our commercial department in case of an enquiry;

☒ Le dimensioni sono espresse in cm - consultare il listino prezzi per le caratteristiche tecniche, i codici degli articoli e delle finiture / Dimensions are stated in cm - for technical characteristics, article code numbers and finishing see price list;

☒ Prodotti non in pronta consegna. Per la disponibilità contattare l'ufficio commerciale / Items not in prompt delivery. Please contact the commercial department to check availability.

Partitions

Le collezioni dedicate agli spazi. Una vasta gamma di soluzioni di pareti e pannelli divisori per ufficio al servizio della funzionalità e della creatività allo scopo di ridisegnare lo spazio che ci circonda.

The collections for your spaces. A wide range of solutions for office walls and dividing panels at the service of functionality and creativity in order to redesign the space that surrounds us.

Single Glass P. 380



Double Glass P. 392



Partition/Storage Wall P. 404



Single Glass

DV602

La serie DV602, parete divisoria monovetro da 3,2 cm, evidenzia essenzialità e tecnicità. Gli elementi caratterizzanti sono: profili perimetrali in alluminio, lastre di vetro stratificato, pannelli in melaminico, porte scorrevoli o battenti e moduli vari.

The DV602 series, a 3,2 cm thick single-glass partition wall, emphasizes simplicity and technicality. The main features are: outer aluminium profiles, laminated glass sheets, melamine panels, sliding or hinged doors and various modules.







Alcuni particolari degli angoli a disposizione per questa parete.

Some details of the angles available for this wall.







Vetro / Glass

Sp. 0.5 + 0.5 cm - 0.6 + 0.6 cm stratificato / 0.5 + 0.5 - 0.6 + 0.6 cm thick, stratified

Sp. 1 + 1.2 cm, temperato / 1 + 1.2 cm thick, tempered

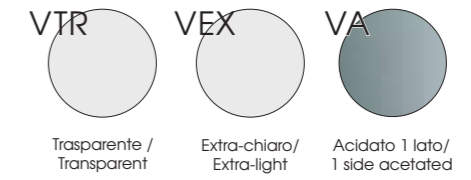
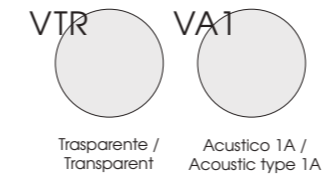

Telaio / Frame

Profilo 3.2 x 4.5 cm, in alluminio / 3.2 x 4.5 cm profile, aluminium

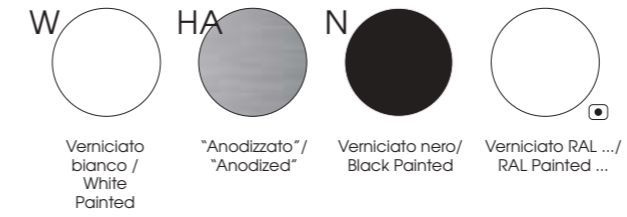

Pannelli (☒) / Panels (☒)

Sp. 2.5 cm, in melaminico / 2.5 cm thick, in melamine

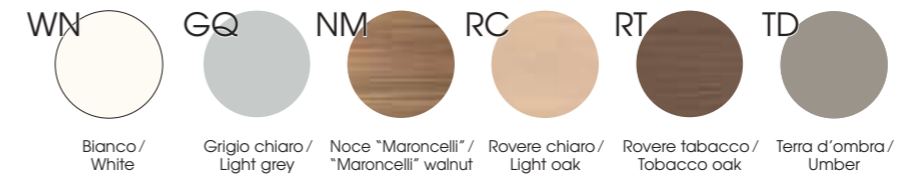

Porte (☒) / Doors (☒)

Sp. 4.4 cm, in melaminico / 4.4 cm thick, in melamine

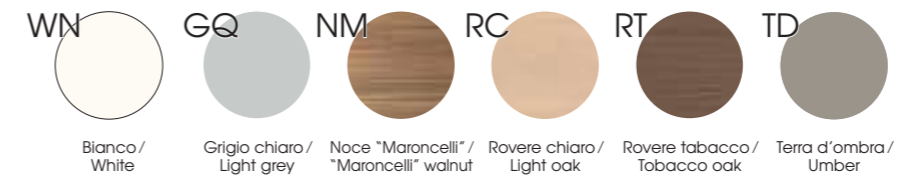

Sp. 4.4 cm, in laccato / 4.4 cm thick, lacquered



Sp. 1 + 1.2 cm, in vetro temperato / 1 + 1.2 cm thick, tempered glass

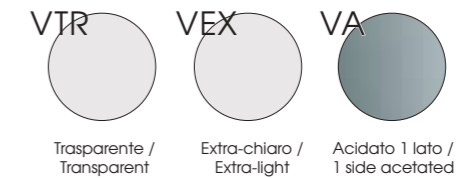

Note

- ☒ A richiesta altre finiture. Per quantitativi minimi contattare l'ufficio commerciale / On request other finishes. For minimum quantities contact the sales office
 ☑ Articoli prodotti solo su richiesta / Articles produced only on request

Pareti monovetro/Mono-glass partitions

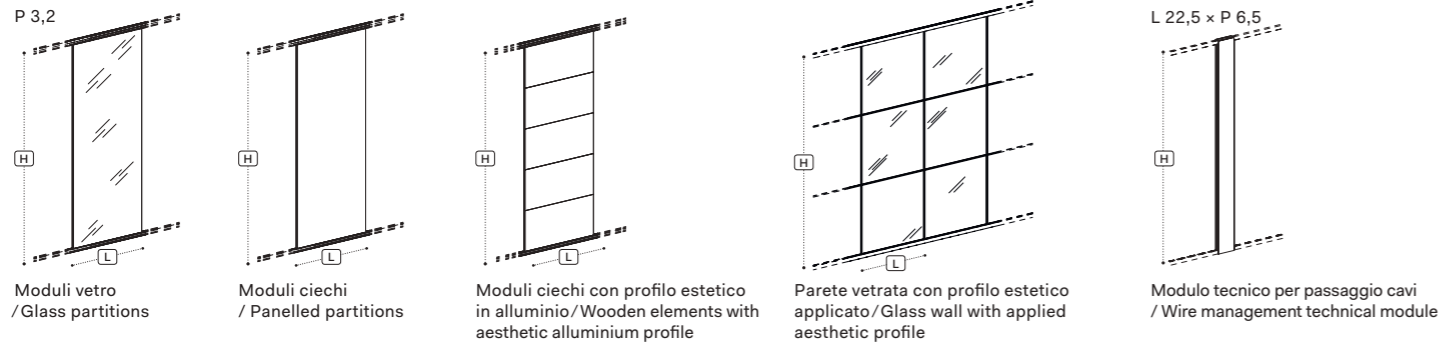

Profili per moduli vetro ad angolo/Glass module corner profile

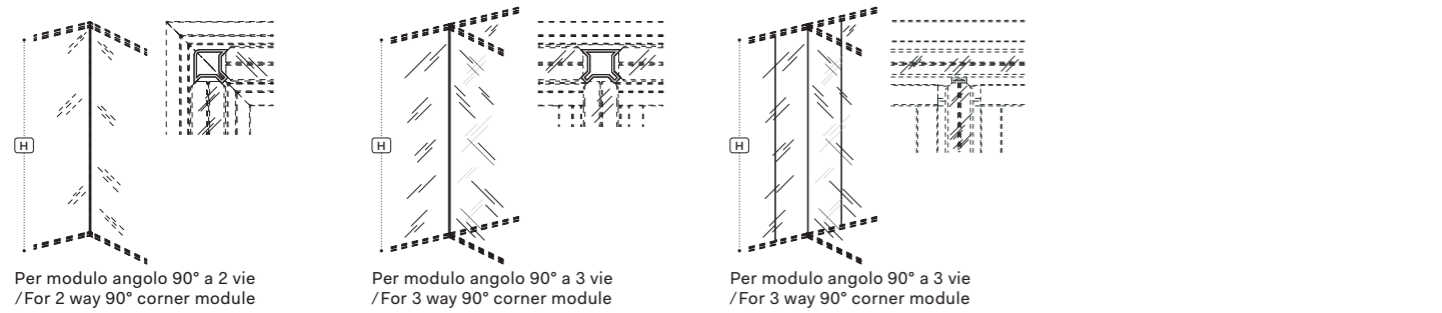

Profili/Profiles

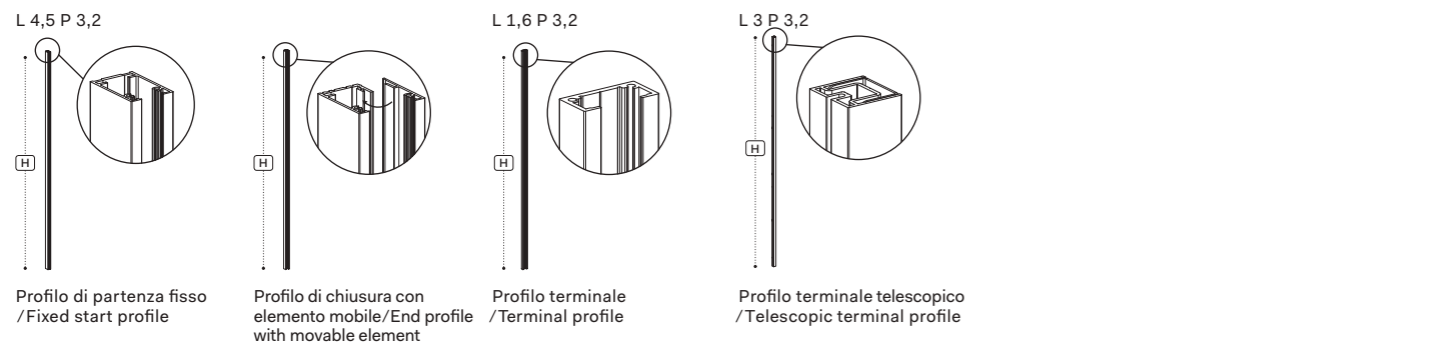

Porte/Doors

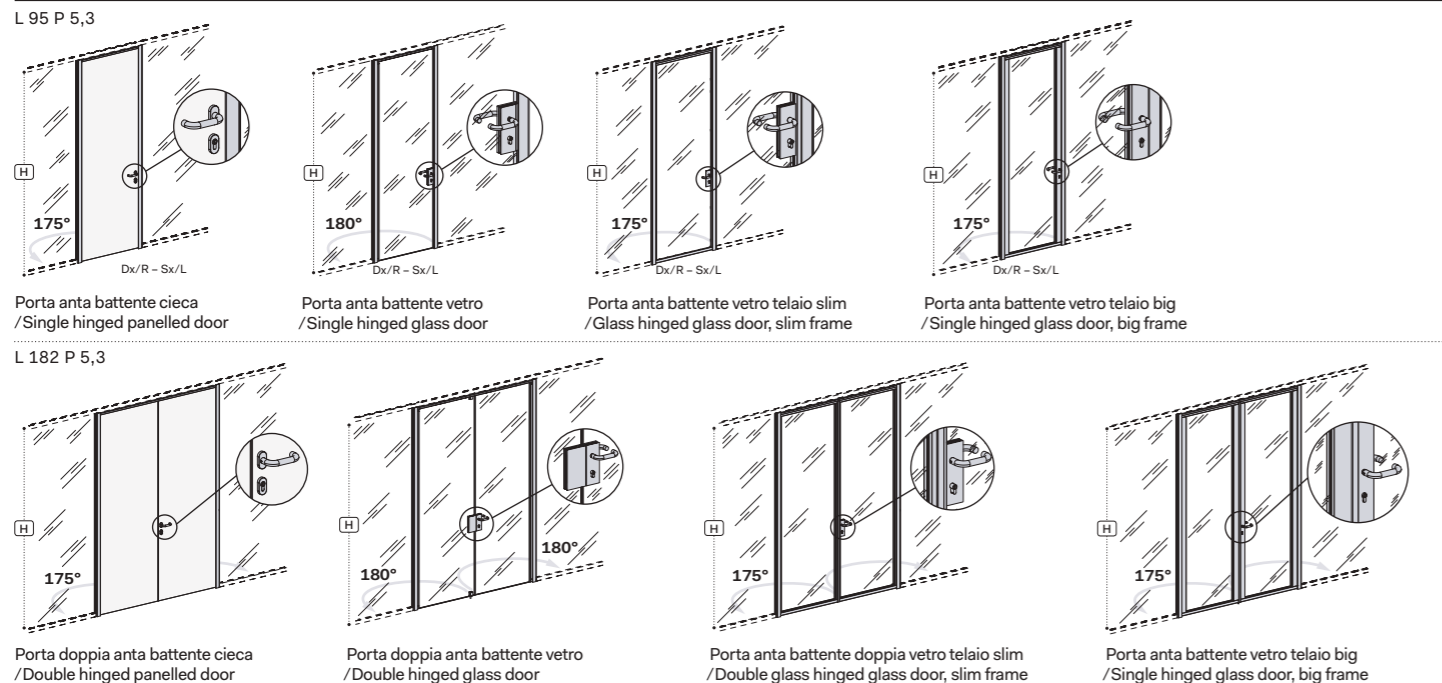

Porte scorrevoli/Sliding doors

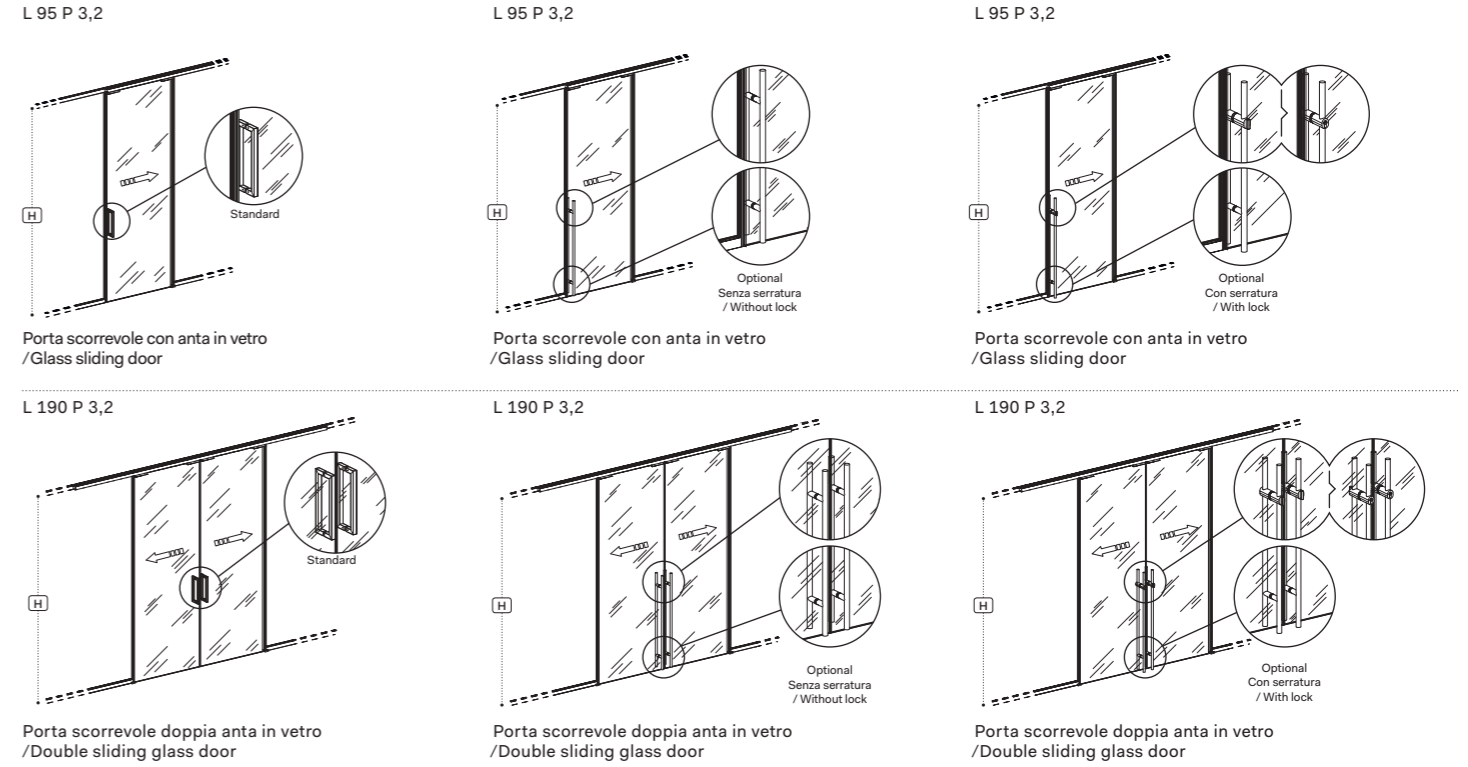

Note:

1 Le dimensioni sono espresse in cm - consultare il listino prezzi per le caratteristiche tecniche, i codici degli articoli e delle finiture / Dimensions are stated in cm - for technical characteristics, article code numbers and finishing see price list;

2 La quotazione delle pareti monovetro verrà effettuata in base ai m² richiesti (HxL) / The quotation of the mono-glass partitions will be calculated according the required square meters (HxL).

Double Glass

DV603

La serie DV603, parete divisoria doppiovetro da 6,4 cm, evidenzia leggerezza e pulizia. Gli elementi caratterizzanti sono: profili perimetrali in alluminio, lastre di vetro stratificato, pannelli in melaminico, porte scorrevoli e battenti, nonché accessori e moduli vari.

The DV603 series, a 6,4 cm thick double-glass partition wall, highlights lightness and clean lines. The main features are: outer profiles in aluminium, laminated glass sheets, melamine panels, sliding and hinged doors as well as accessories and various modules.









Alcuni particolari che caratterizzano questa parete.

Some details that characterize this wall.



Vetro / Glass

Sp. 0.5 + 0.5 cm - 0.6 + 0.6 cm stratificato / 0.5 + 0.5 - 0.6 + 0.6 cm thick, stratified

Sp. 1 + 1.2 cm, temperato / 1 + 1.2 cm thick, tempered

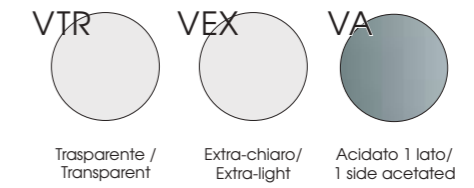
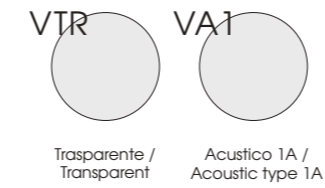

Telaio / Frame

Profilo 3.2 x 4.5 cm, in alluminio / 3.2 x 4.5 cm profile, aluminium

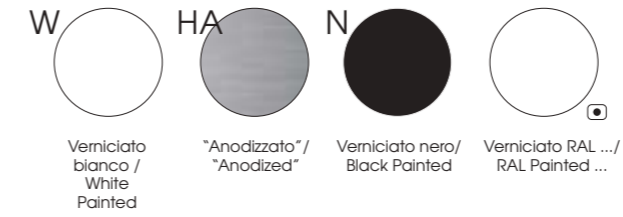

Pannelli ☒ / Panels ☒

Sp. 2.5 cm, in melaminico / 2.5 cm thick, in melamine

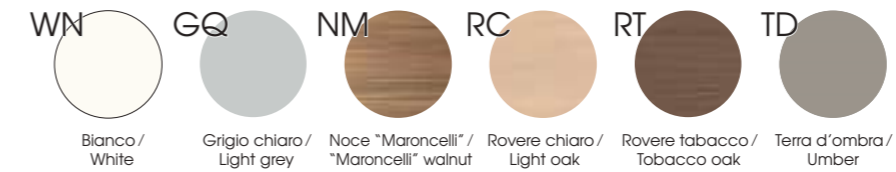

Porte ☒ / Doors ☒

Sp. 4.4 cm, in melaminico / 4.4 cm thick, in melamine

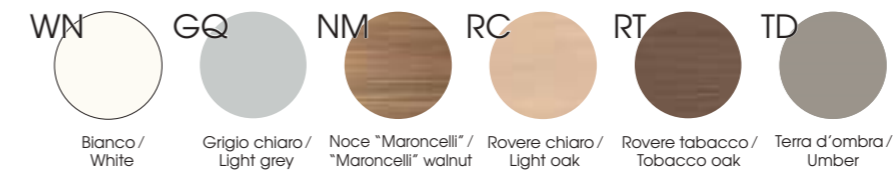

Sp. 4.4 cm, in laccato / 4.4 cm thick, lacquered



Sp. 1 + 1.2 cm, in vetro temperato / 1 + 1.2 cm thick, tempered glass

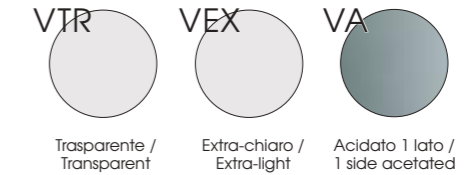

Note

☒ A richiesta altre finiture. Per quantitativi minimi contattare l'ufficio commerciale / On request other finishes. For minimum quantities contact the sales office

☐ Articoli prodotti solo su richiesta / Articles produced only on request

Pareti doppiovetro/Double-glass partitions

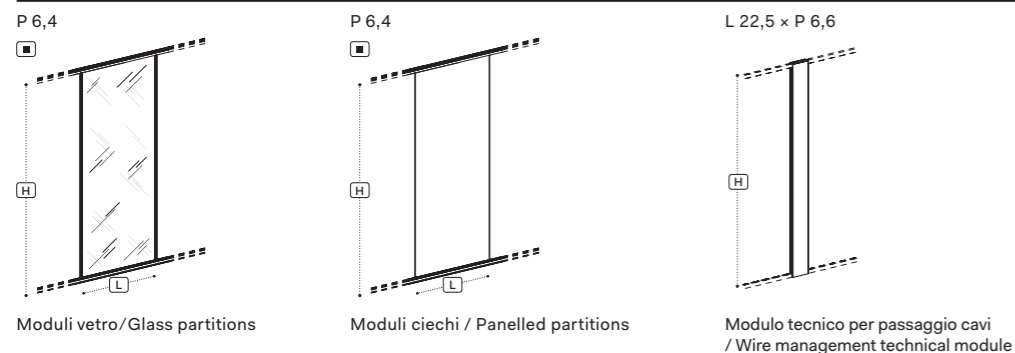

Profili per moduli vetro ad angolo/Glass module corner profiles

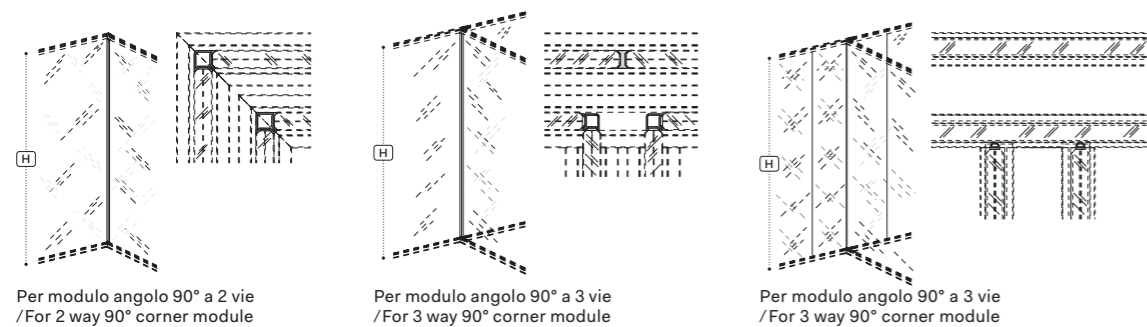

Profili/Profiles

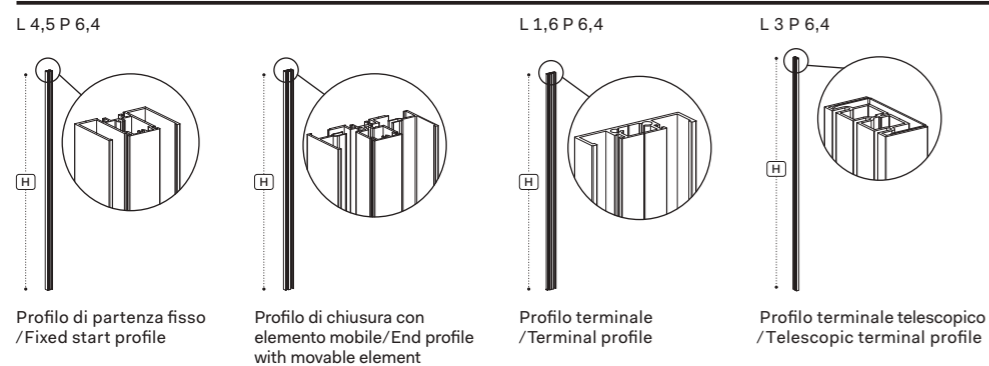

Porte/Doors

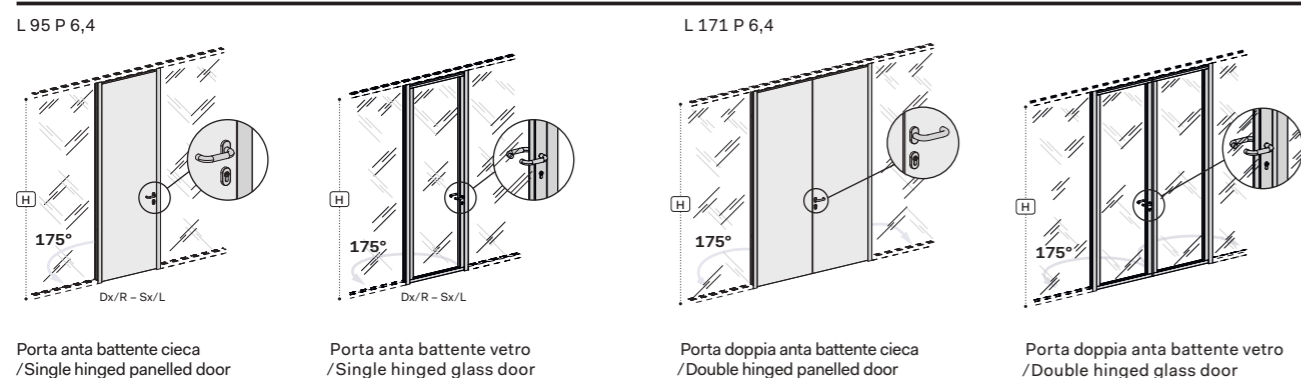

Porte scorrevoli/Sliding doors

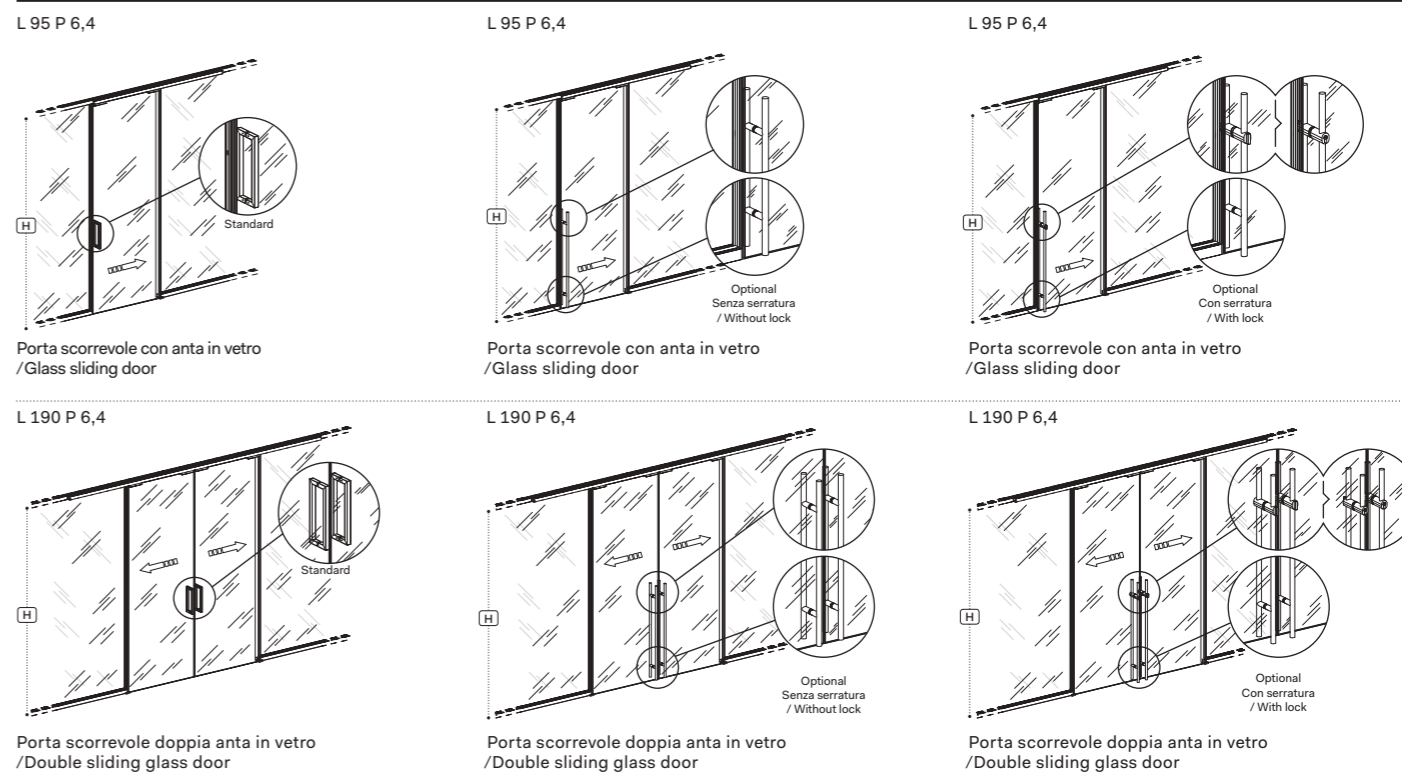

Note:

1 Le dimensioni sono espresse in cm - consultare il listino prezzi per le caratteristiche tecniche, i codici degli articoli e delle finiture/Dimensions are stated in cm - for technical characteristics, article code numbers and finishing see price list;

2 La quotazione delle pareti monovetro verrà effettuata in base ai m² richiesti (HxL)/The quotation of the mono-glass partitions will be calculated according the required square meters (HxL).

Partition Wall

DV604

Storage Wall

DV605

La parete divisoria da 10 cm con struttura in acciaio, è predisposta per essere rivestita con coppie di pannelli contrapposti in melaminico o vetro. Possibile integrazione con la parete attrezzata.

The partition wall with a steel frame 10 cm thick, is designed to be plated with pairs of opposed panels in melamine or glass. Possibility of integration with storage wall system.

La parete attrezzata da 46,5 cm, mette in evidenza funzionalità e completezza per ogni esigenza ufficio. Sono previste diverse tipologie di moduli contenitori. Possibile integrazione con le pareti in vetro singole e con quelle divisorie.

The 46.5 cm storage wall system, highlights functionality and completeness for every office need. There are different types of container modules. Integration with single glass walls possible and with the dividing ones.









Vetro / Glass

Sp. 0,5 + 0,5 cm, temperato / 0,5 + 0,5 cm, tempered



Telaio vetrato / Glass frame

Sp. 1,8 cm, in alluminio / 1,8 cm thick, aluminium



Zoccolo in metallo / Metal Base



Completamenti in metallo / Metal Completions



Pannelli ☒ / Panels ☒

Sp. 1,8 cm, in melaminico / 1,8 cm thick, in melamine



Porte ☒ / Doors ☒

Sp. 4,4 cm, in melaminico / 4,4 cm thick, in melamine



Sp. 1 cm, in vetro temperato / 1 cm thick, tempered glass

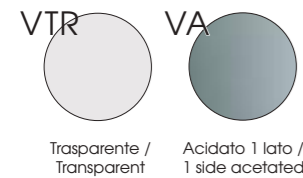

Schema dimensionale parete divisoria / Scheme of partition dimensions

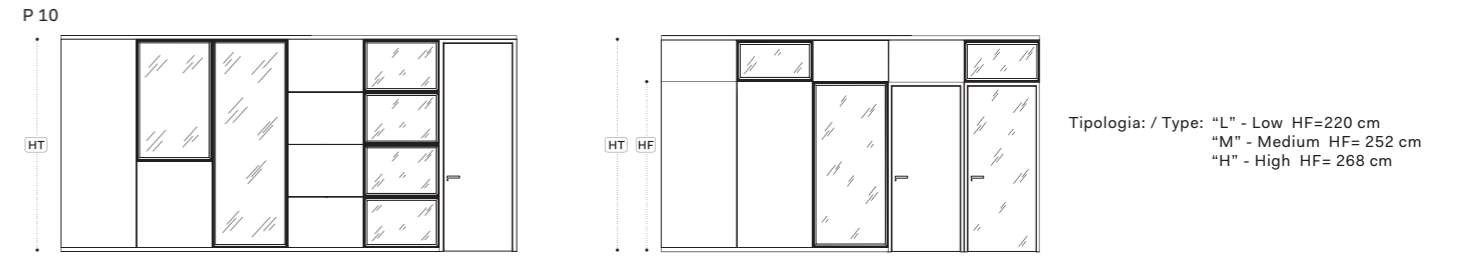

Moduli tutta altezza / Module full height

HT = Altezza totale / Total height HF = Altezza filo parete / Upper line

Schema dimensionale parete divisoria / Scheme of partition dimensions

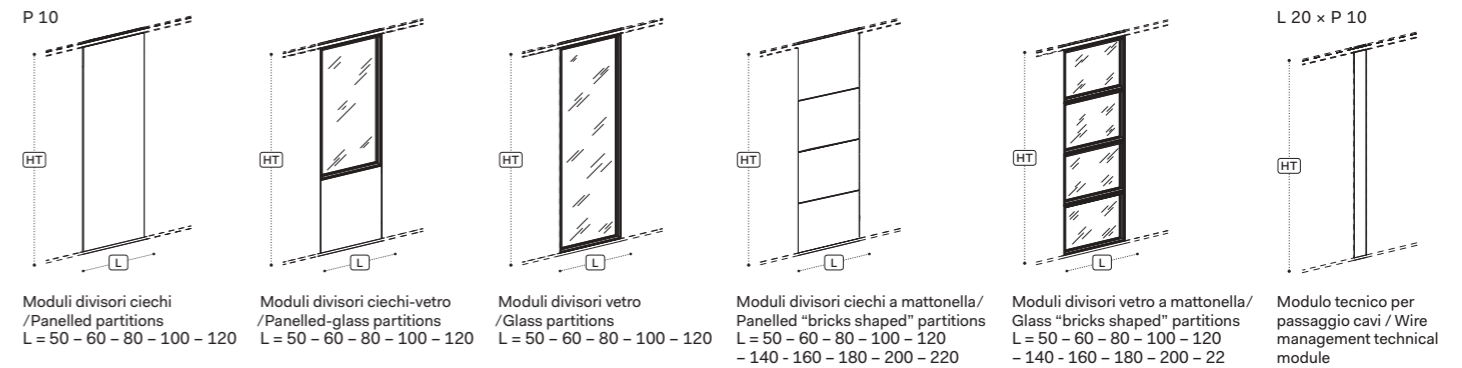

Porte / Doors

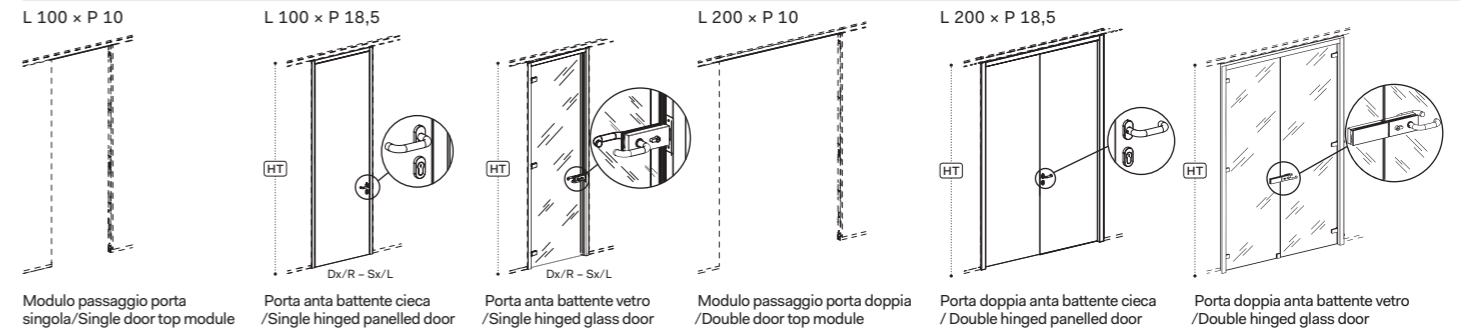

Fasce di tamponamento / Fillers

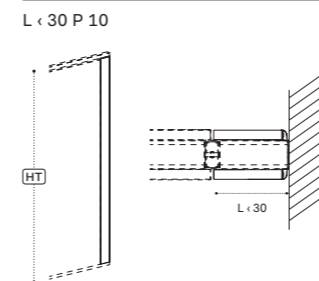

Angoli e testate / Corner and terminal profiles

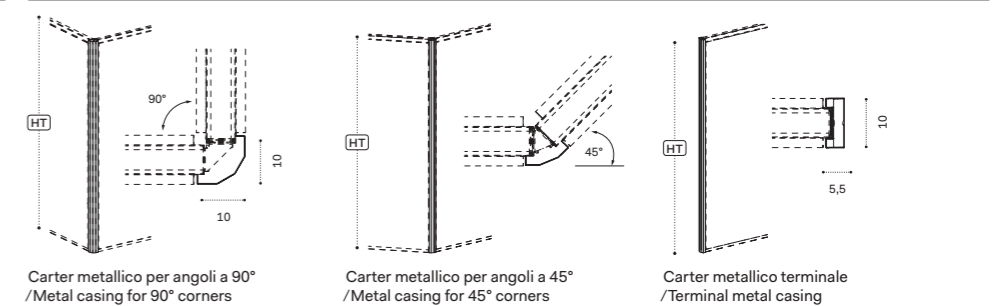

Accessori / Accessories

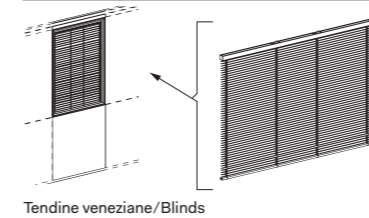

Note

☒ A richiesta altre finiture. Per quantitativi minimi contattare l'ufficio commerciale / On request other finishes. For minimum quantities contact the sales office

Note:

1 Le dimensioni sono espresse in cm - consultare il listino prezzi per le caratteristiche tecniche, i codici degli articoli e delle finiture / Dimensions are stated in cm - for technical characteristics, article code numbers and finishing see price list;

2 Le pareti divisorie DV604 possono essere abbinare alle pareti attrezzate DV605 / The DV604 partition wall systems can be combined with the DV605 ones.

Scocca / Body

Sp. 1.8 cm, in melaminico / 1.8 cm thick, in melamine

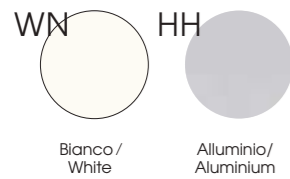

Ripiani / Shelves

Sp. 2.5 cm, in melaminico / 2.5 cm thick, in melamine



Sp. 2.8 cm, in metallo / 2.8 cm thick, in metal

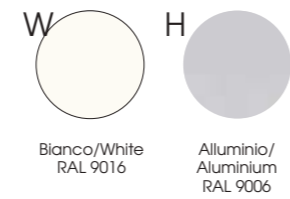

Ante battenti (H) / Hinged doors (H)

Sp. 1.8 cm, in melaminico / 1.8 cm thick, in melamine



Sp. 0.4 cm, in vetro temperato con telaio in alluminio anodizzato sp. 2 cm / 0.4 cm thick, tempered glass with anodized aluminium frame 2 cm thick



Zoccolo in metallo / Metal Base

Maniglie / Handles

Q - V - T

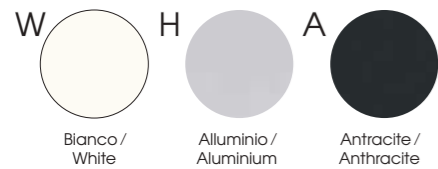

XBR



Interasse/Centers 96 mm, 256 mm, 256 mm



Interasse/Centers 96 mm

Porte (H) / Doors (H)

Sp. 4.4 cm, in melaminico / 4.4 cm thick, in melamine



Sp. 1 cm, in vetro temperato / 1 cm thick, tempered glass

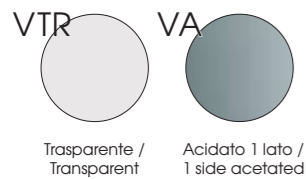

Moduli contenitori monofacciali / Single sided storage modules

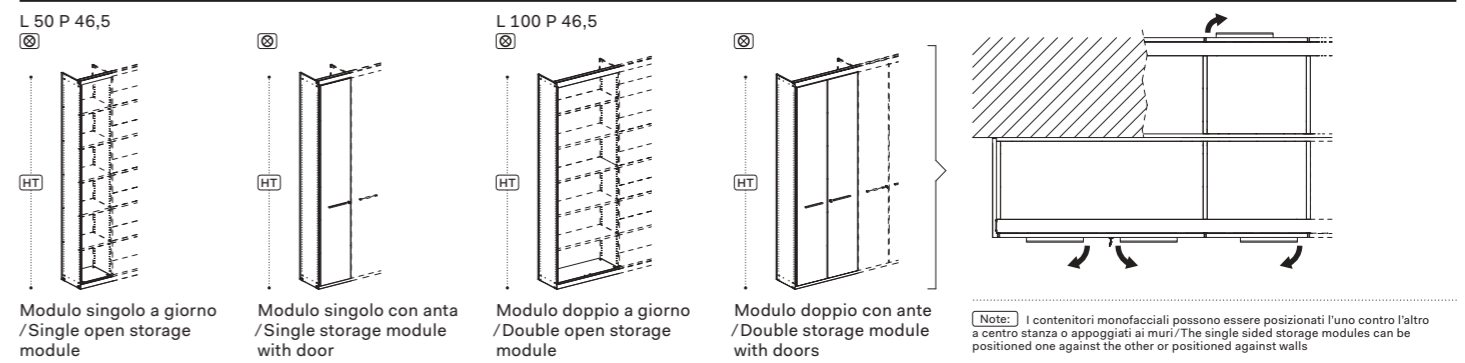

Moduli contenitori monofacciali / Single sided storage modules

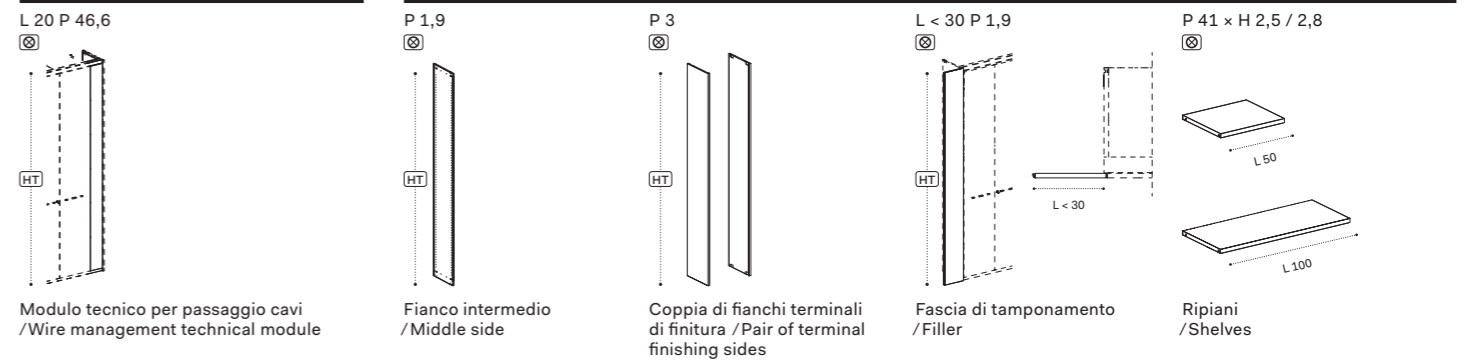

Configurare la composizione e aggiungere di conseguenza all'ordine: una coppia di fianchi terminali o le fasce di tamponamento, un fianco intermedio e i ripiani metallici / Configure your composition and consequently add: a pair of side terminal panels or side fillers, a middle side panel and metal shelves

Moduli contenitori bifacciali / Double sided storage modules

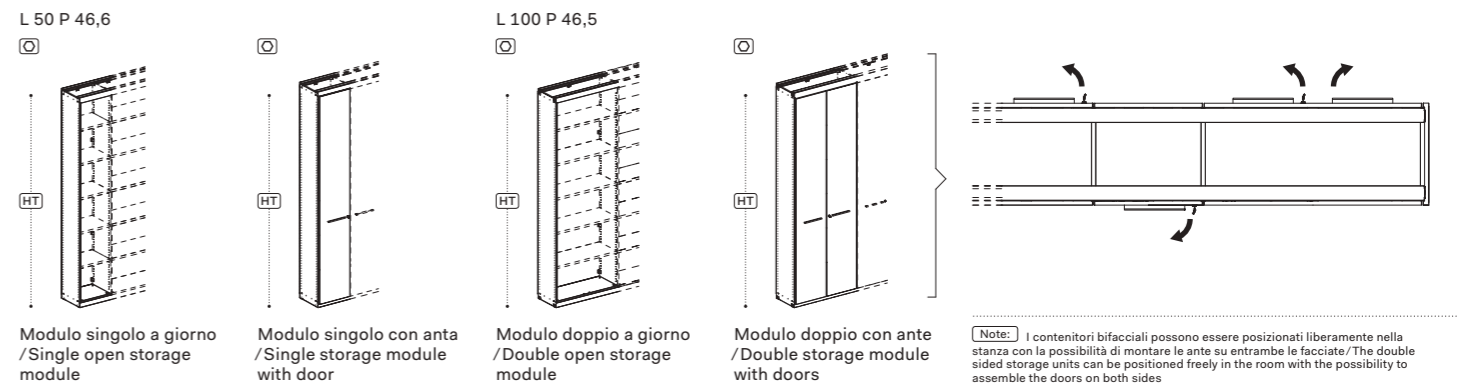

Moduli contenitori bifacciali / Double sided storage modules

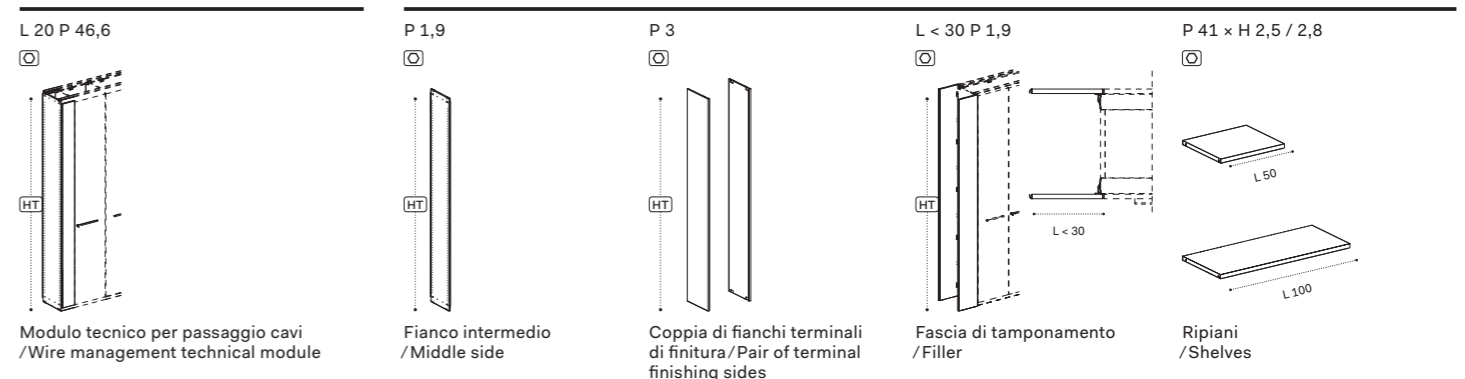

Note:

- 1 Le dimensioni sono espresse in cm - consultare il listino prezzi per le caratteristiche tecniche, i codici degli articoli e delle finiture / Dimensions are stated in cm - for technical characteristics, article code numbers and finishing see price list;
- 2 Le paretine divisorie DV605 possono essere abbinare alle pareti attrezzate DV604 / The DV605 partition wall systems can be combined with the DV604 ones.

Porte per contenitori bifacciali/Doors for double sided storage modules

L 100 P 46,5

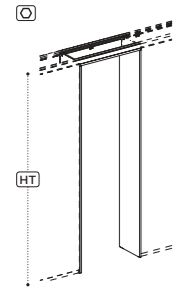

Modulo passaggio porta/Door top module

L 100 P 18,5

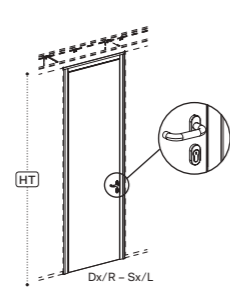

Porta cieca/Panelled door

L 100 P 18,5

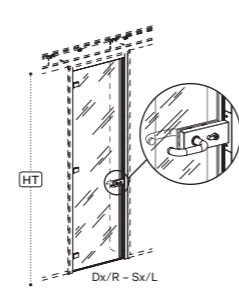

Porta vetro/Glass door

Configurare la composizione e aggiungere di conseguenza all'ordine: una coppia di fianchi terminali o le fasce di tamponamento, un fianco intermedio e i ripiani metallici/Configure your composition and consequently add: a pair of side terminal panels or side fillers, a middle side panel and metal shelves

Moduli contenitori monofacciali sottofinestra/Low single sided storage units

L 50 P 48,5 x H 108

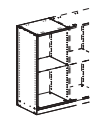

Modulo singolo a giorno/Single open storage module

L 50 P 48,5 x H 108

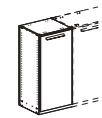

Modulo singolo con ante/Single storage module with door

L 100 P 48,5 x H 108

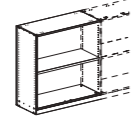

Modulo doppio a giorno/Double open storage module

L 100 P 48,5 x H 108

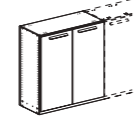

Modulo doppio con ante/Double storage module with doors

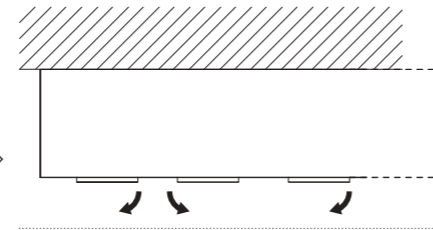

Note: I contenitori sottofinestra vanno sempre appoggiati alle pareti/Storage units below windows always need to be positioned against the wall

Componenti per contenitori monofacciali sottofinestra/Components for low single sided storage units

P 1,9 H 108



Fianco intermedio/Middle side

P 1,9 H 108

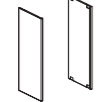

Coppia di fianchi terminali di finitura/Pair of terminal finishing sides

L < 30 P 1,9 x H 108

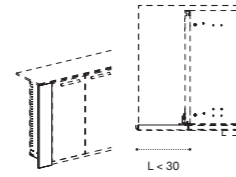

Fascia di tamponamento/Filler

P 49,2 - H 1,9



Top

Configurare la composizione e aggiungere di conseguenza all'ordine: una coppia di fianchi terminali o le fasce di tamponamento, un fianco intermedio, i ripiani metallici e il top/Configure your composition and consequently add: a pair of side terminal panels or side fillers, a middle side panel, metal shelves and top.

Accessori/Accessories

L 50

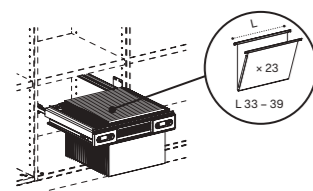

Portacartelle estraibile L 50/Filling pull-out frames L 50

L 100

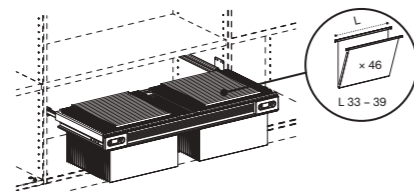

Portacartelle estraibile L 100/Filling pull-out frames L 100

L 100+150 P 49,2 x H 110

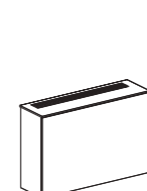

Mobile copri fan coil/Furniture unit to hide fan coil units

Note:

Le dimensioni sono espresse in cm - consultare il listino prezzi per le caratteristiche tecniche, i codici degli articoli e delle finiture/Dimensions are stated in cm - for technical characteristics, article code numbers and finishing see price list;

Le pareti divisorie DV605 possono essere abbinare alle pareti attrezzate DV604/The DV605 partition wall systems can be combined with the DV604 ones.

Fonoisolamento/Sound insulation Cc

DV602

Performance

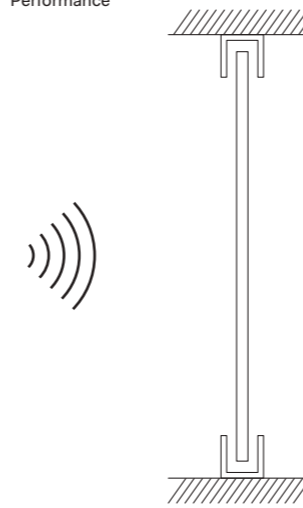

Glass 5.5.1 ≥ 34 dB
Glass 5.5.1A ≥ 36 dB
Glass 6.6.1A ≥ 38 dB

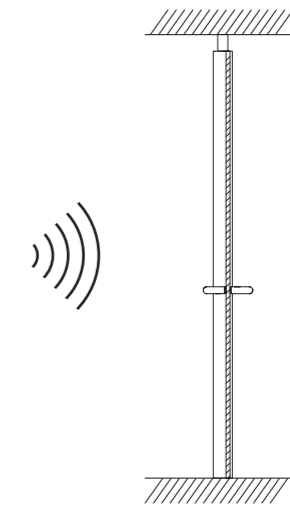

Hinged door with continuous hinge ≥ 26 dB

DV603

Performance

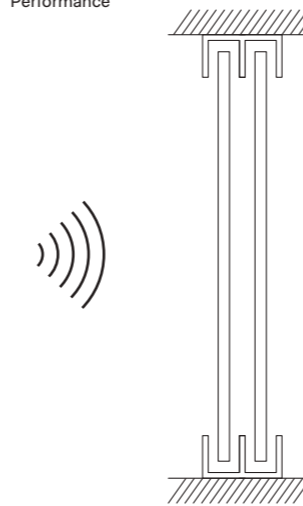

Glass 5.5.1 ≥ 42 dB
Glass 5.5.1A ≥ 45 dB
Glass 6.6.1A ≥ 46 dB

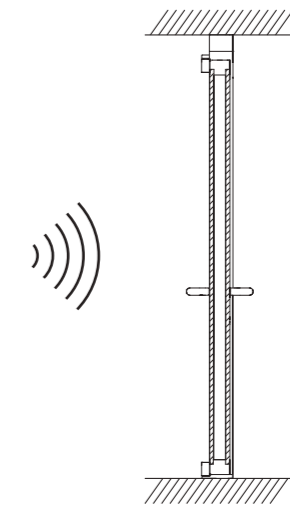

Hinged double glass door ≥ 40 dB

DV604

Performance

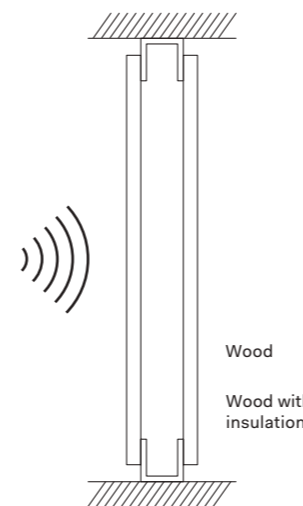

Wood ≥ 39 dB
Wood with insulation ≥ 44 dB



Glass ≥ 42 dB

DV605

Performance

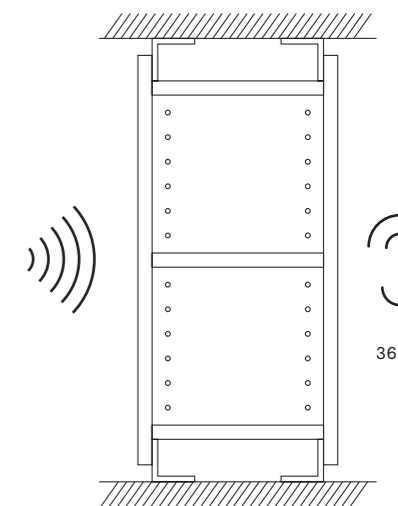

36 dB

Storages

Le collezioni dedicate alla funzionalità. Una vasta gamma di librerie componibili e armadi per ufficio con soluzioni che si adattano perfettamente ad ogni esigenza: capacità contenitiva, organizzazione, molteplicità delle combinazioni e funzionalità.

The collections dedicated to the functionality. A wide range of modular bookcases and office cabinets with solutions that adapt perfectly to every need: storage capacity, organization, multiplicity of combinations and functionality.

Universal Storage P. 420



Milo P. 434



Rio P. 448



Roma P. 460



Riga P. 468



Taba P. 476



Boiserie P. 486



Seul P. 494



Lockers P. 502



Pedestals P. 510



Universal Storage DV503

I "Contenitori universali" rispondono concretamente alle diverse esigenze dello spazio di lavoro mediante una vasta gamma di moduli attrezzabili destinati all'archiviazione e al contenimento.

The "Universal storage" units concretely respond to the different needs of a working environment through a wide range of modules that can be equipped and devoted to storage and filing.

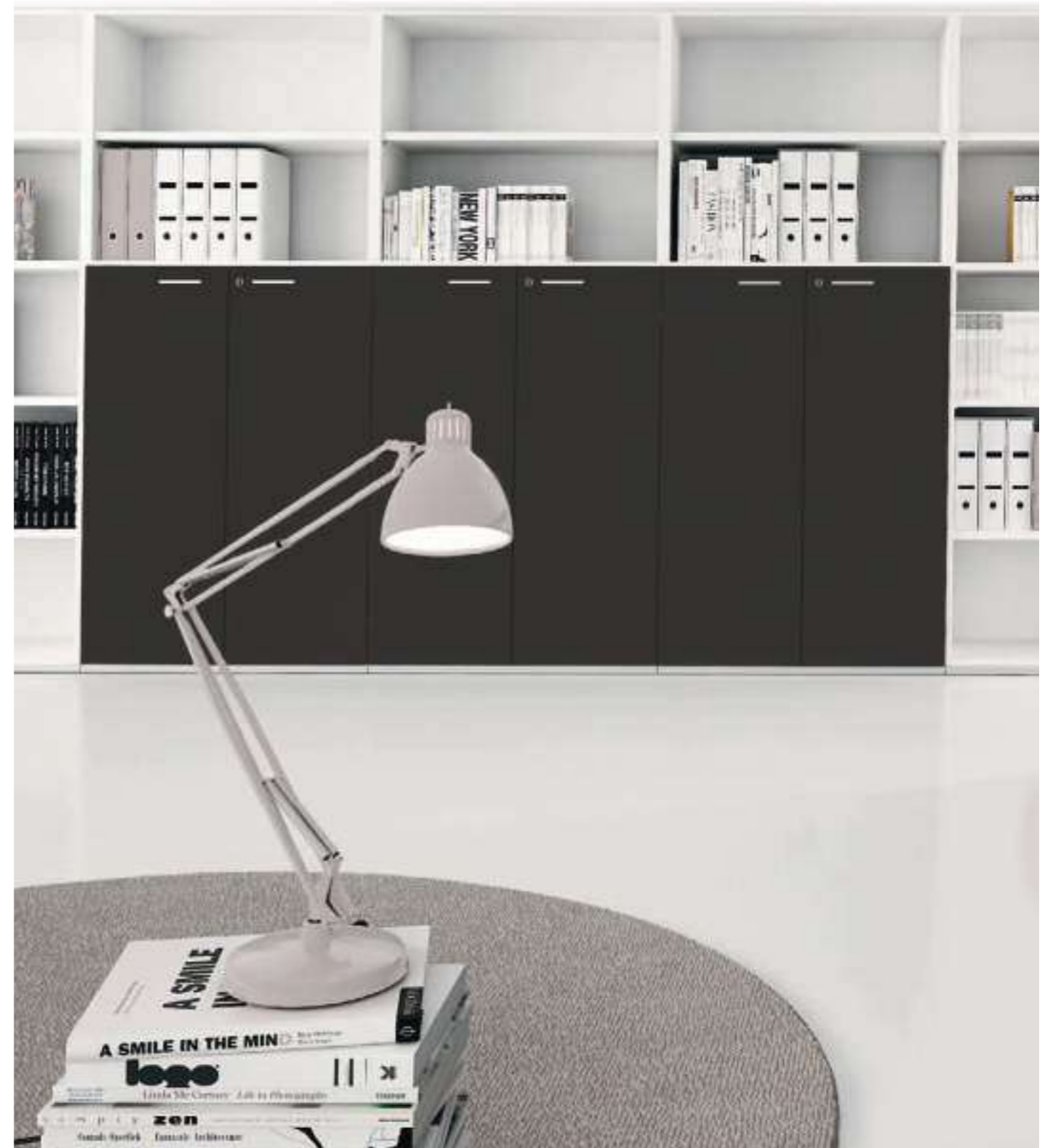



La qualità funzionale,
formale ed estetica
garantisce un
prodotto esclusivo
nella molteplicità
delle dimensioni
e delle tipologie.

*The functional,
formal and
aesthetical quality
guarantees an
exclusive product
in a variety of
sizes and types.*



N.B.: Le dimensioni indicate in **blu**, comprendono lo spessore del top 1.8 cm. Le dimensioni indicate in **verde** comprendono lo spessore delle ante 1.8 cm / The above **blue** dimensions, include the 3/4" thickness of the top. The above **green** dimensions, include the 3/4" thickness of the doors

* I contenitori H. 242.5 cm sono disponibili solo con profondità 45 cm / The storages units H. 95 4/6" are available only in 17 3/4" depth

🔒 Con serratura / With lock



Nuove fioriere integrabili ai Contenitori universali /
New planters that can be integrated with Universal Storage



L. 90 cm - P. 43 cm - H. 25 cm
W. 35 7/13" - D. 16 15/16" - H. 9 13/16"

L. 90 cm - P. 45 cm - H. 25 cm
W. 35 7/13" - D. 17 3/4" - H. 9 13/16"

Contenitori / Storage units

Scocca e fioriera sp. 1.8 cm; ripiani sp. 2.5 cm, in melaminico /
Body and planter 1.8 cm thick; shelves 2.5 cm thick, in melamine

Ripiani sp. 2.5 cm, in metallo / Shelves 2.5 cm thick, in metal

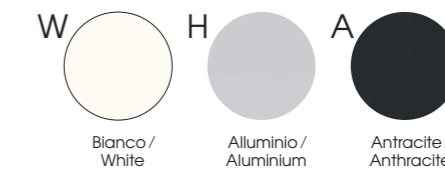
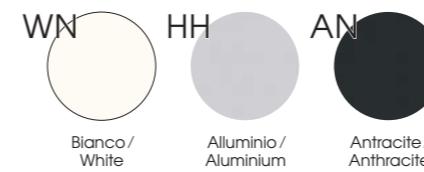

Ante, frontali cassetto e frontali fioriera sp. 1.8 cm, in melaminico (*) o laminato (**)/ Doors, drawer fronts and planter fronts 1.8 cm thick, in melamine (*) or laminate (**)

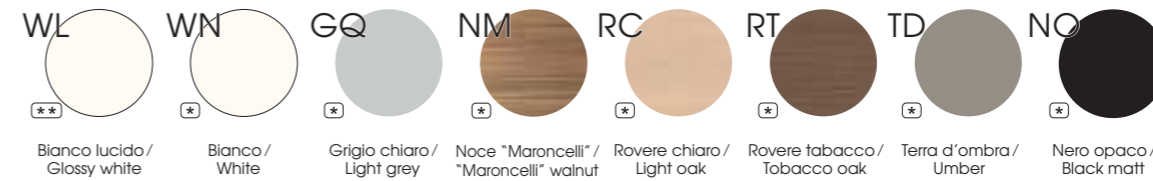

Ante sp. 0.4 cm, in vetro temprato con telaio in alluminio anodizzato sp. 2 cm
(H 124.4/159.6/204.4 cm) / Doors 0.4 cm thick, tempered glass with anodized
aluminium frame 2 cm thick (H 124.4/159.6/204.4 cm)

Ante sp. 0.4 cm, in vetro temprato con telaio in alluminio anodizzato sp. 2 cm
(H 79.6/124.4/159.6/204.4 cm) / Doors 0.4 cm thick, tempered glass with anodized
aluminium frame 2 cm thick (H 79.6/124.4/159.6/204.4 cm)



Fianchi di finitura sp. 1.8 cm, in melaminico (*) o laminato (**)/ Decorative side 1.8 cm thick, in melamine (*) or laminate (**)

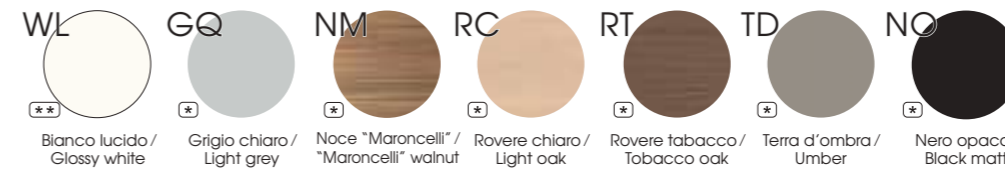

Top e schiene sp. 1.8 cm, in melaminico (*) o laminato (**)/ Top and backs 1.8 cm thick, in melamine (*) or laminate (**)



Maniglie / Handles

Q - V - T

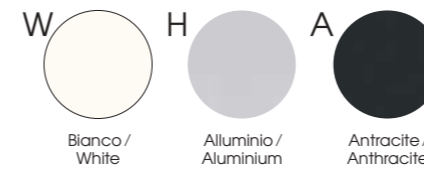

XBR

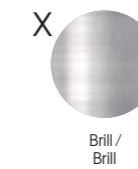

Contenitori universali/Universal storage units

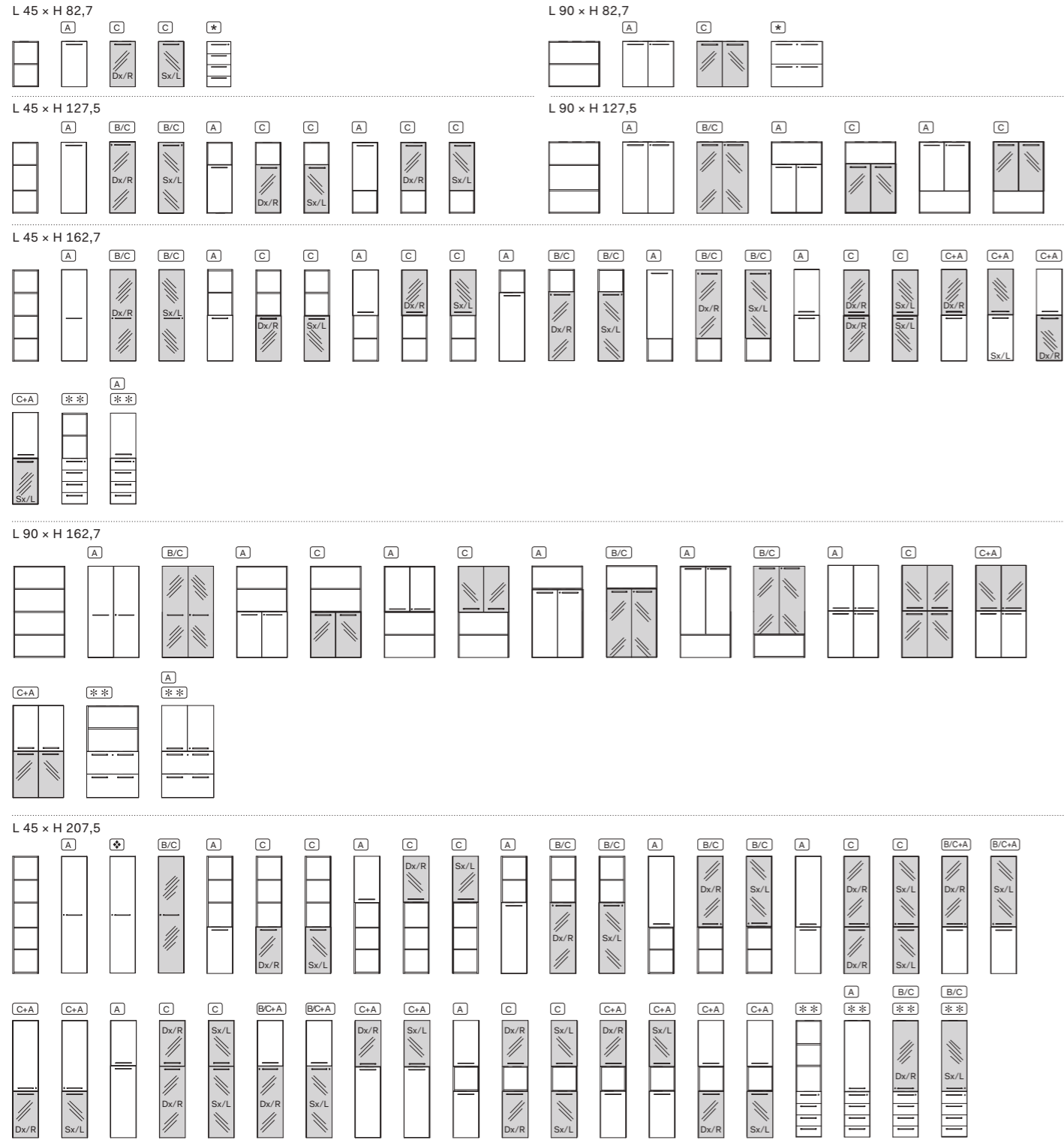

Note:

Tipologie ante vetro disponibili / Available glass doors

A Anta in melaminico / Wooden door;

B Anta vetro acidato con telaio in alluminio dotata di serratura / Acetated glass door with aluminium frame and lock;

C Anta vetro retrolaccato con telaio in alluminio / Rear-lacquered glass door with aluminium frame;

I contenitori P 35 cm sono disponibili solo con ripiani in melaminico / 35 cm deep storage units are available only with melamine shelves;

☒ Contenitori appendiabiti disponibili solo P 45 cm / Wardrobe storage units only available in 45 cm depth;

☒ Contenitori disponibili solo P 45 cm / Storage units available only in 45 cm depth;

☒☒ Contenitori sovrapposti disponibili solo P 45 cm / Stackable storage units only available in 45 cm depth;

1 Le dimensioni sono espresse in cm - consultare il listino prezzi per le caratteristiche tecniche, i codici degli articoli e delle finiture / Dimensions are stated in cm - for technical characteristics, article code numbers and finishing see price list.

Contenitori universali/Universal storage units

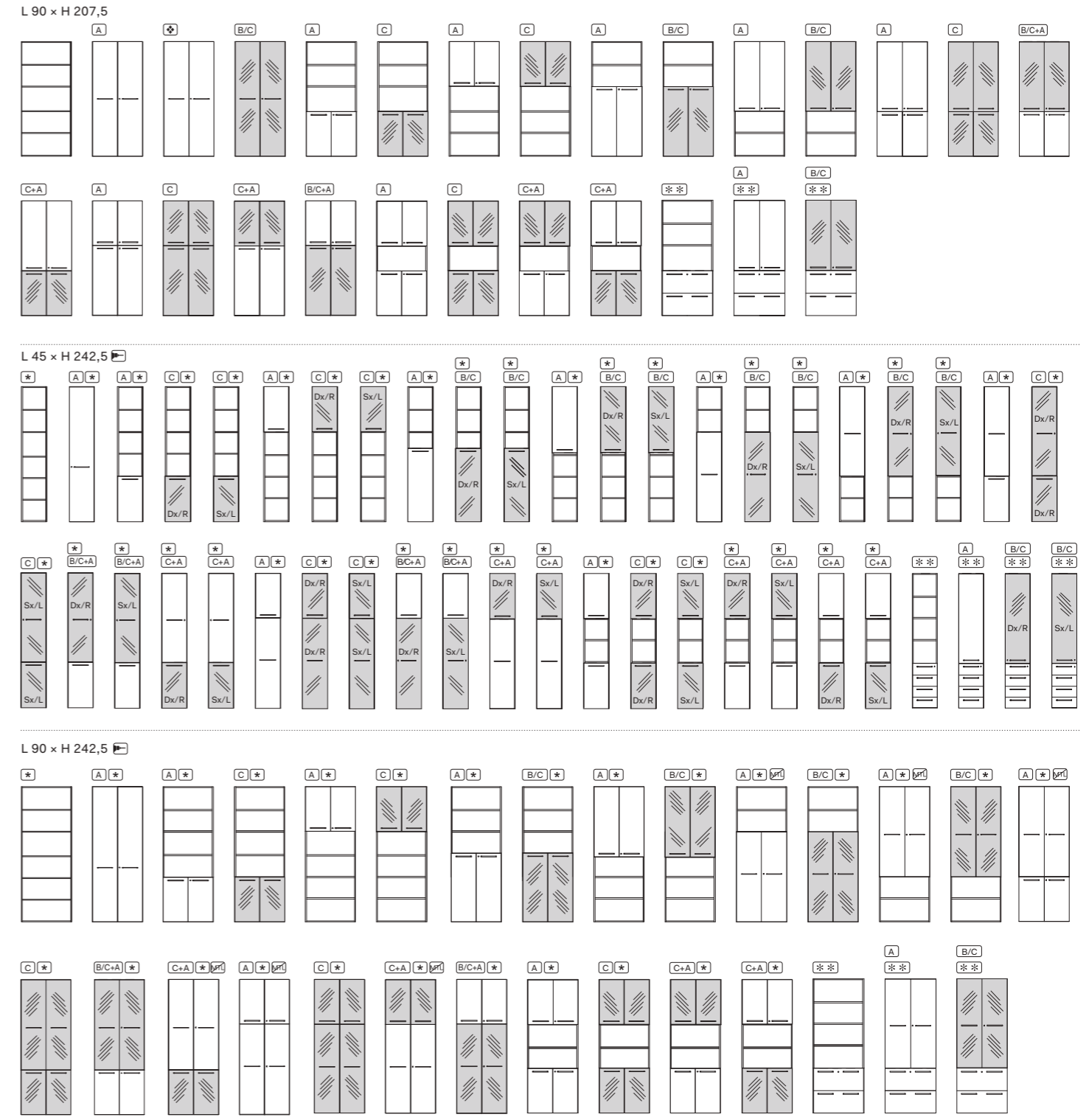

Note: ATTENZIONE: Ripiano in metallo non utilizzabile nelle composizioni contrassegnate con il simbolo ☒ / ATTENTION: Metal shelf not usable in compositions marked with the symbol ☒

Note:

Tipologie ante vetro disponibili / Available glass doors

A Anta in melaminico / Wooden door;

B Anta vetro acidato con telaio in alluminio dotata di serratura / Acetated glass door with aluminium frame and lock;

C Anta vetro retrolaccato con telaio in alluminio / Rear-lacquered glass door with aluminium frame;

I contenitori P 35 cm sono disponibili solo con ripiani in melaminico / 35 cm deep storage units are available only with melamine shelves;

☒ Contenitori attrezzati disponibili solo P 45 cm / Storage units with accessories only available in 45 cm depth;

☒ Contenitori disponibili solo P 45 cm / Storage units available only in 45 cm depth;

☒☒ Contenitori sovrapposti disponibili solo P 45 cm / Stackable storage units only available in 45 cm depth;

1 Le dimensioni sono espresse in cm - consultare il listino prezzi per le caratteristiche tecniche, i codici degli articoli e delle finiture / Dimensions are stated in cm - for technical characteristics, article code numbers and finishing see price list.

☒ I contenitori H 242,5 cm vanno sempre fissati a muro e completati di zoccoli metallici. / The storage units H 242,5 must be fixed to the wall and completed with metal plinth.

Contenitori a giorno/Open storage units

L 45 x H 82,7 		L 90 x H 82,7 		Note: 503..._A..._P 33,2 / 503..._B..._P 43: Ripiano in melaminico/Melamine shelf 503..._M..._P 43: Ripiano in metallo/Metal shelf Tipologie maniglie disponibili/ Available handle typologies Maniglia "Q" e "XBR" utilizzabile solo con ante piene o ante in vetro acidate / Handle "Q" e "XBR" to be used only with wooden doors or acetated glass door									
503.CU.GA.08.11 _ P 33,2 503.CU.GB.08.11 _ P 43 503.CU.GM.08.11 _ P 43		503.CU.GA.08.21 _ P 33,2 503.CU.GB.08.21 _ P 43 503.CU.GM.08.21 _ P 43											
L 45 x H 127,5 		L 45 x H 127,5 		L 90 x H 127,5 		L 90 x H 127,5 							
503.CU.GA.12.11 _ P 33,2 503.CU.GB.12.11 _ P 43 503.CU.GM.12.11 _ P 43		503.CU.SA.12.11 _ P 33,2 503.CU.SB.12.11 _ P 43 503.CU.SM.12.11 _ P 43		503.CU.GA.12.21 _ P 33,2 503.CU.GB.12.21 _ P 43 503.CU.GM.12.21 _ P 43		503.CU.SA.12.21 _ P 33,2 503.CU.SB.12.21 _ P 43 503.CU.SM.12.21 _ P 43							
L 45 x H 162,7 		L 45 x H 162,7 		L 90 x H 162,7 		L 90 x H 162,7 		L 90 x H 162,7 					
503.CU.GA.16.11 _ P 33,2 503.CU.GB.16.11 _ P 43 503.CU.GM.16.11 _ P 43		503.CU.SA.16.11 _ P 33,2 503.CU.SB.16.11 _ P 43 503.CU.SM.16.11 _ P 43		503.CU.GA.16.21 _ P 33,2 503.CU.GB.16.21 _ P 43 503.CU.GM.16.21 _ P 43		503.CU.SA.16.21 _ P 33,2 503.CU.SB.16.21 _ P 43 503.CU.SM.16.21 _ P 43		503.CU.EA.16.21 _ P 33,2 503.CU.EB.16.21 _ P 43 503.CU.EM.16.21 _ P 43					
		Per ante sovrapposte o parziali /For overlapped or partial doors		Per ante parziali o vano a giorno /For partial doors and open space		Per ante sovrapposte o parziali /For overlapped or partial doors		Per ante in vetro con telaio in all. anod. /For glass doors with anod. alumim. frame					
L 45 x H 207,5 		L 45 x H 207,5 		L 45 x H 207,5 		L 90 x H 207,5 		L 90 x H 207,5 		L 90 x H 207,5 		L 90 x H 207,5 	
503.CU.GA.20.11 _ P 33,2 503.CU.GB.20.11 _ P 43 503.CU.GM.20.11 _ P 43		503.CU.SA.20.11 _ P 33,2 503.CU.SB.20.11 _ P 43 503.CU.SM.20.11 _ P 43		503.CU.NA.20.11 _ P 33,2 503.CU.NB.20.11 _ P 43 503.CU.NM.20.11 _ P 43		503.CU.GA.20.21 _ P 33,2 503.CU.GB.20.21 _ P 43 503.CU.GM.20.21 _ P 43		503.CU.SA.20.21 _ P 33,2 503.CU.SB.20.21 _ P 43 503.CU.SM.20.21 _ P 43		503.CU.NA.20.21 _ P 33,2 503.CU.NB.20.21 _ P 43 503.CU.NM.20.21 _ P 43		503.CU.EA.20.21 _ P 33,2 503.CU.EB.20.21 _ P 43 503.CU.EM.20.21 _ P 43	
		Per ante sovrapposte o parziali /For overlapped or partial doors		Per ante parziali o vano a giorno /For partial doors and open space		Per ante sovrapposte o parziali /For overlapped or partial doors		Per ante parziali o vano a giorno /For partial doors and open space		Per ante in vetro acidato/For acetated tempered glass doors			
L 45 x H 242,5 		L 45 x H 242,5 		L 45 x H 242,5 		L 90 x H 242,5 		L 90 x H 242,5 		L 90 x H 242,5 		L 90 x H 242,5 	
503.CU.GB.24.11 _ P 43 503.CU.GM.24.11 _ P 43		503.CU.SB.24.11 _ P 43 503.CU.SM.24.11 _ P 43		503.CU.NB.24.11 _ P 43 503.CU.NM.24.11 _ P 43		503.CU.GB.24.21 _ P 43 503.CU.GM.24.21 _ P 43		503.CU.SB.24.21 _ P 43		503.CU.NB.24.21 _ P 43 503.CU.NM.24.21 _ P 43		503.CU.EB.24.21 _ P 43 503.CU.EM.24.21 _ P 43	
		Per ante sovrapposte o parziali /For overlapped or partial doors		Per ante parziali o vano a giorno /For partial doors and open space		Per ante sovrapposte o parziali /For overlapped or partial doors		Per ante parziali o vano a giorno /For partial doors and open space		Per ante parziali H 159,6 in vetro acidato/For partial doors H 159,6 in acetated tempered glass			

Contenitori attrezzati/Storage units with accessories

L 45 P 45 x H82,7 	L 90 P 45 x H82,7 	L 90 P 45 x H82,7 	L 90 P 45 x H82,7 	L 90 P 45 x H82,7 	L 89,9 P 42,8 x H 2,8 	L 45 P 45 x H 207,5 	L 90 P 45 x H 207,5
503.CU.C0.08_	503.CU.L0.08_	503.CU.F0.08_	503.CU.F0.09_	503.CU.F0.10_	503.CU.ZF.09_	503.CU.P0.20.11_	503.CU.P0.20.21_
					Zoccolo metallico per contenitore basso con frigo bar./Base metal frame for unit with wooden doors and mini-bar		

Note:

- Le dimensioni sono espresse in cm - consultare il listino prezzi per le caratteristiche tecniche, i codici degli articoli e delle finiture/Dimensions are stated in cm - for technical characteristics, article code numbers and finishing see price list;
- I contenitori H 242,5 cm vanno sempre fissati a muro e completati di zoccoli metallici;/The storage units H 242,5 must be fixed to the wall and completed with metal plinth;
- Frigo-bar/Mini-bar.
- Con serratura/With lock;
- I contenitori H 242,5 non possono essere integrati con le ante H 204,4;/The storage units H 242,5 cannot be integrated with H 204,4 doors;

Ante piene A/Wooden doors A

L 44,7 P 1,8 x H 79,6 	L 89,6 P 1,8 x H 79,6 	L 89,6 P 1,8 x H 79,6 	L 44,7 P 1,8 x H 124,4 	L 89,6 P 1,8 x H 124,4 	L 89,6 P 1,8 x H 124,4
503.CA.10.08_	503.CA.20.08_	503.CA.30.08_	503.CA.10.12_	503.CA.20.12_	503.CA.30.12_
L 44,7 - P 1,8 - H 159,6 	L 89,6 - P 1,8 - H 159,6 	L 44,7 - P 1,8 - H 204,4 	L 89,6 - P 1,8 - H 204,4 	L 44,7 - P 1,8 - H 239,6 	L 89,6 - P 1,8 - H 239,6
503.CA.10.15_	503.CA.20.15_	503.CA.10.20_	503.CA.20.20_	503.CA.10.24_	503.CA.20.24_

Composizioni contenitori con ante in melaminico / Composition with storage units with wooden doors A

L 45 P 35 x H 82,7 		L 45 P 45 x H 82,7 		L 90 P 35 x H 82,7 		L 90 P 45 x H 82,7 		Note: 503..._A..._P 33,2 / 503..._B..._P 43: Ripiano in melaminico/Melamine shelf 503..._M..._P 43: Ripiano in metallo/Metal shelf Tipologie maniglie disponibili/ Available handle typologies Maniglia "Q" e "XBR" utilizzabile solo con ante piene o ante in vetro acidate / Handle "Q" e "XBR" to be used only with wooden doors or acetated glass door			
503.CC.A0.01_		503.CC.B0.01_		503.CC.A0.02_		503.CC.B0.02_					
		503.CC.M0.01_		503.CC.M0.02_							
L 45 P 35 x H 127,5 		L 45 P 45 x H 127,5 		L 90 P 35 x H 127,5 		L 90 P 45 x H 127,5 		L 45 P 35 x H 162,7 		L 45 P 45 x H 162,7 	
503.CC.A0.03_		503.CC.B0.03_		503.CC.A0.04_		503.CC.B0.04_		503.CC.A0.05_		503.CC.B0.05_	
		503.CC.M0.03_		503.CC.M0.04_		503.CC.M0.05_					
L 90 P 35 x H 162,7 		L 90 P 45 x H 162,7 		L 45 P 35 x H 207,5 		L 45 P 45 x H 207,5 		L 90 P 35 x H 207,5 		L 90 P 45 x H 207,5 	
503.CC.A0.06_		503.CC.B0.06_		503.CC.A0.07_		503.CC.B0.07_		503.CC.A0.08_		503.CC.B0.08_	
		503.CC.M0.06_		503.CC.M0.07_		503.CC.M0.08_					
L 45 P 35 x H 207,5 		L 45 P 45 x H 207,5 		L 90 P 35 x H 207,5 		L 90 P 45 x H 207,5 		L 45 P 45 x H 242,5 		L 90 P 45 x H 242,5 	
503.CC.A0.09_		503.CC.B0.09_		503.CC.A0.10_		503.CC.B0.10_		503.CC.B0.21_		503.CC.B0.22_	
		503.CC.M0.09_		503.CC.M0.10_		503.CC.M0.10_		503.CC.M0.21_		503.CC.M0.22_	
L 45 P 45 x H 242,5 		L 90 P 45 x H 242,5 									
503.CC.B0.23_		503.CC.M0.23_									
		503.CC.B0.24_									

Note:

- Le dimensioni sono espresse in cm - consultare il listino prezzi per le caratteristiche tecniche, i codici degli articoli e delle finiture/Dimensions are stated in cm - for technical characteristics, article code numbers and finishing see price list;
- I contenitori H 242,5 cm vanno sempre fissati a muro e completati di zoccoli metallici./The storage units H 242,5 must be fixed to the wall and completed with metal plinth.
- Con serratura/With lock;

Ante in vetro acidato con telaio in alluminio anodizzato / Acetated glass doors with anodised aluminium frame

L 44,7 P 2 x H 124,4 L 89,6 P 2 x H 124,4 L 44,7 P 2 x H 159,6 L 89,6 P 2 x H 159,6 L 44,7 P 2 x H 204,4 L 89,6 P 2 x H 204,4

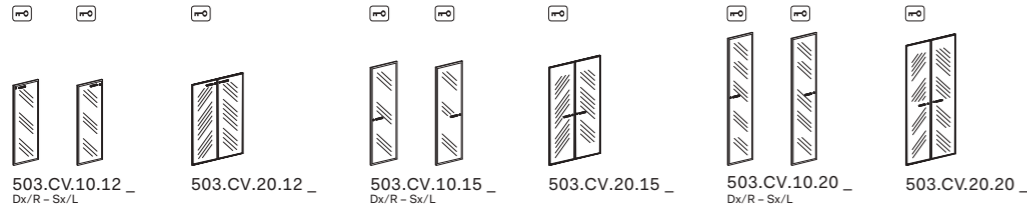

Ante in vetro retrolaccato con telaio in alluminio anodizzato / Rear lacquered glass doors with anodised aluminium frame

L 44,7 P 2 x H 79,6 L 89,6 P 2 x H 79,6 L 44,7 P 2 x H 124,4 L 89,6 P 2 x H 124,4 L 44,7 P 2 x H 159,6 L 89,6 P 2 x H 159,6 L 44,7 P 2 x H 204,4 L 89,6 P 2 x H 204,4

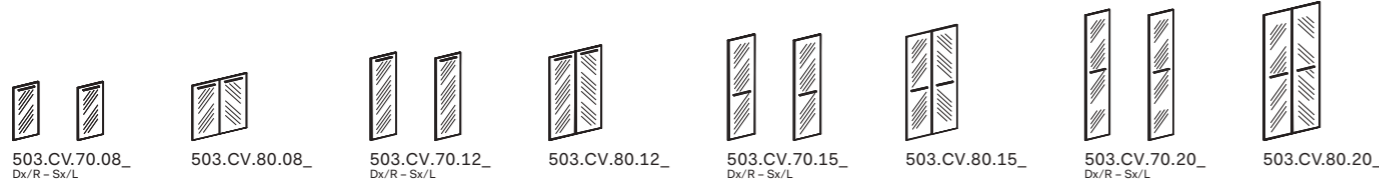

Composizioni contenitori con ante in vetro acidato con telaio in alluminio dotate di serratura / Storage units compositions with acetated glass door with aluminium frame and lock

L 45 P 35 x H 127,5 L 45 P 45 x H 127,5 L 90 P 35 x H 127,5 L 90 P 45 x H 127,5

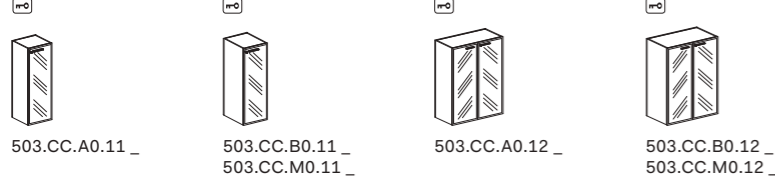

Note:
503...A...P 33,2 / 503...B...P 43: Ripiano in melaminico/Melamine shelf
503...M...P 43: Ripiano in metallo/Metal shelf

Tipologie maniglie disponibili/Available handle typologies

Maniglia "Q" e "XBR" utilizzabile solo con ante piene o ante in vetro acidate
/ Handle "Q" e "XBR" to be used only with wooden doors or acetated glass door

L 45 P 35 x H 162,7 L 45 P 45 x H 162,7 L 90 P 35 x H 162,7 L 90 P 45 x H 162,7 L 45 P 35 x H 207,5 L 45 P 45 x H 207,5 L 90 P 35 x H 207,5

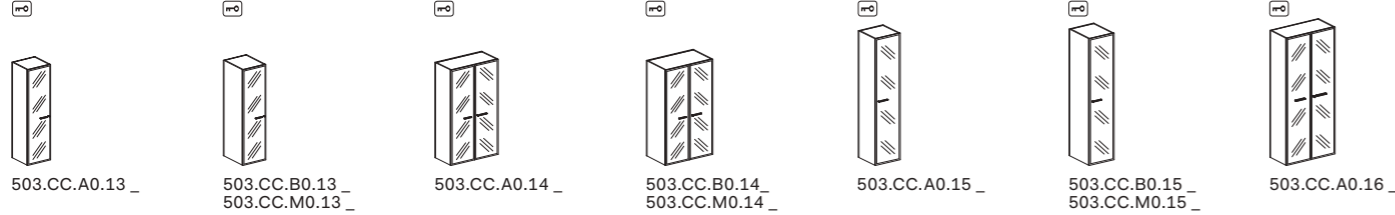

L 90 P 45 x H 207,5 L 45 P 35 x H 207,5 L 45 P 45 x H 207,5 L 90 P 35 x H 207,5 L 90 P 45 x H 207,5 L 45 P 45 x H 242,5 L 90 P 45 x H 242,5

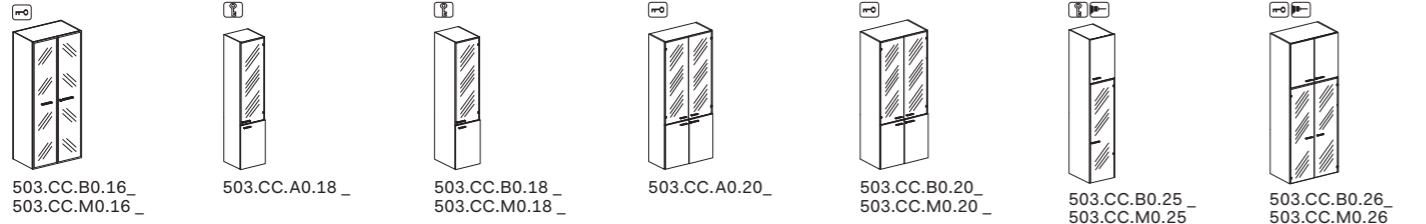

Contenitori H 74/Storage units H 74

L 80 P 33 x 71,5 L 80 P 33 x 71,5

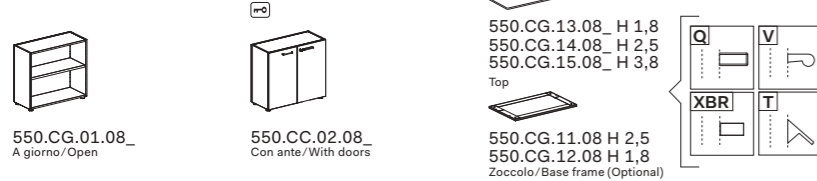

Note: Aggiungere sempre il Top sp. 1,8 o 2,5 (altezza totale è di 74 cm); 3,8 cm (altezza totale è di 75,5 cm) / Always add the 1,8 or 2,5 cm thick tops (height is 74 cm); 3,8 cm (height is 75,5 cm)

Note:
 Le dimensioni sono espresse in cm - consultare il listino prezzi per le caratteristiche tecniche, i codici degli articoli e delle finiture/Dimensions are stated in cm - for technical characteristics, article code numbers and finishing see price list;
 I contenitori H 242,5 cm vanno sempre fissati a muro e completati di zoccoli metallici.
/The storage units H 242,5 must be fixed to the wall and completed with metal plinth.

Con serratura/With lock;
 Con serratura (solo ante superiore-inferiore in vetro)/With lock (only upper-lower glass door);

Componenti e accessori per contenitori/Components and accessories for storage units

H 2,8

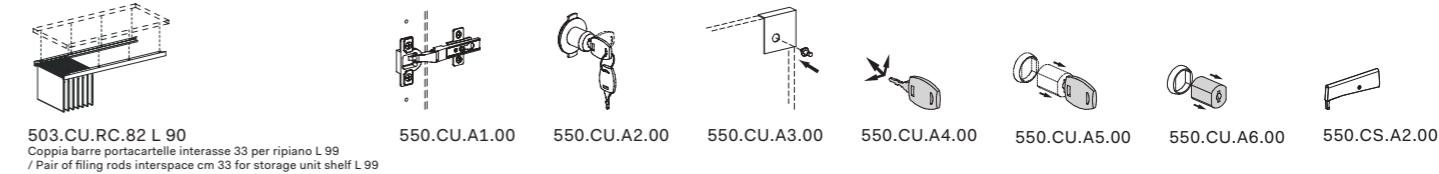
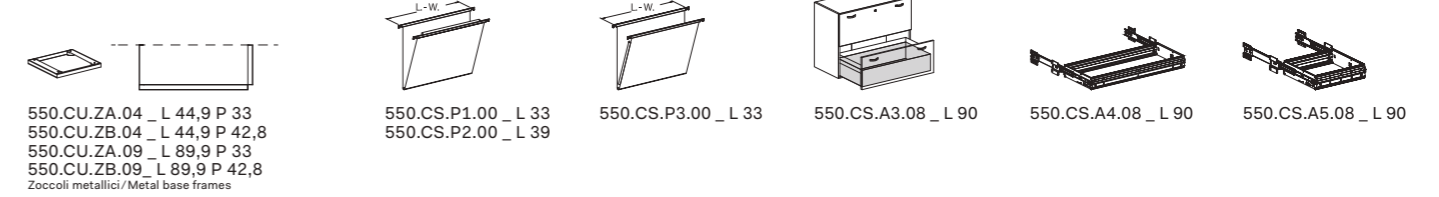

Componenti e accessori per contenitori/Components and accessories for storage units

P 35/45 x H 1,8

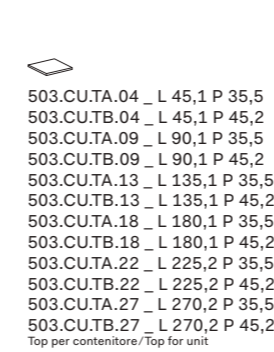

P 47,2 x H 1,8

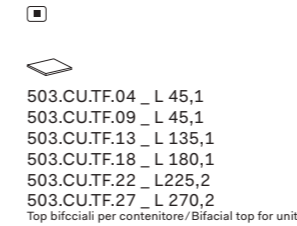

L 1,8

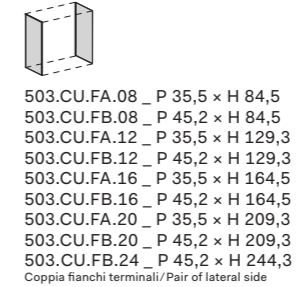

P 1,8

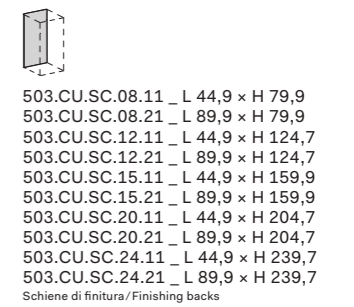

L 41,4 x H 2,5

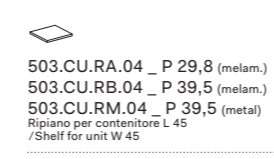

L 41,4 x H 2,5

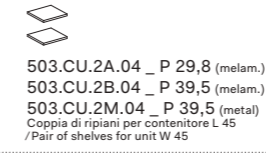

L 86 x H 2,5

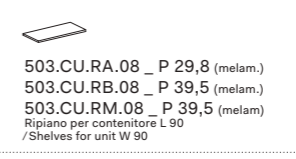

L 86 x H 2,5

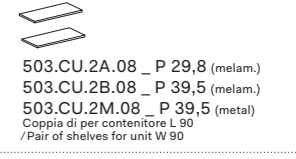

L 41,4 x H 2,5

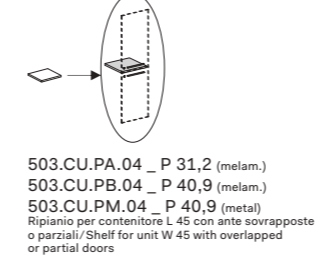

L 86,4 x H 2,5

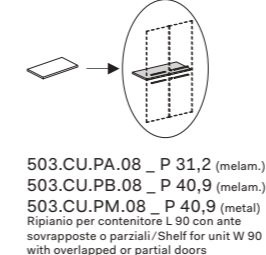

L 86,4 x H 2,5

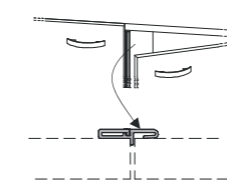
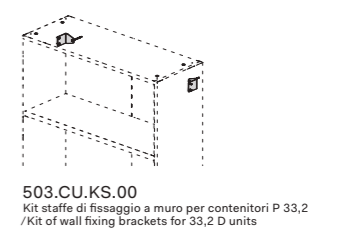
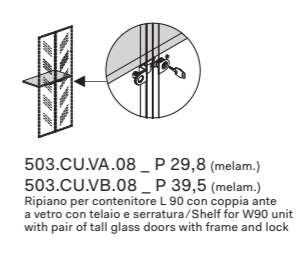

L 90 P 43 x H 25

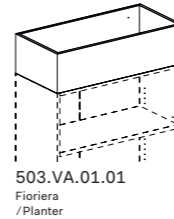

L 90 P 1,8 x H 25

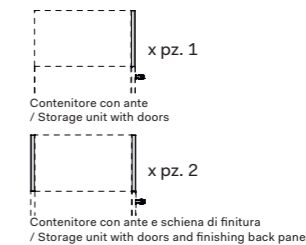
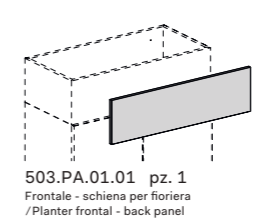

Note:
 Le dimensioni sono espresse in cm - consultare il listino prezzi per le caratteristiche tecniche, i codici degli articoli e delle finiture/Dimensions are stated in cm - for technical characteristics, article code numbers and finishing see price list;
 I contenitori sono componibili, sovrapponibili e vanno completati con i top/storage units are modular, stackable and they must be completed with tops;

Prodotti non in pronta consegna. Per la disponibilità contattare l'ufficio commerciale/Items not in prompt delivery. Please contact the commercial department to check availability;

Con serratura/With lock;
 Fino ad esaurimento/Until exhaustion.

Milo

DV504

Sistema di madie su basamenti e contenitori pensili, agganciati ad una barra retroilluminata che ricorda la linea dell'orizzonte e contribuisce a conferire un senso di benessere all'ambiente ufficio. La libertà compositiva è massima.

System of sideboards with stands and wall units, hooked to a backlight bar that recalls the horizon and helps give a sense of wellbeing to the office. Maximum freedom of composition is allowed.









Grazie ad un semplice gesto, Milo si trasforma in una scrivania orientabile comoda e funzionale.

Thanks to a simple gesture, the Milo is transformed into a comfortable and functional swivel desk.







Moduli base / Modules

Scocche in melaminico sp. 1.8 cm, in folding / Folding melamine bodies 1.8 cm thick

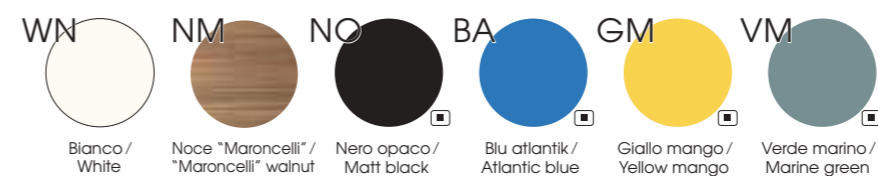

Ante, frontali cassetti e schiene di finitura in melaminico sp. 1.8 cm / Melamine doors, drawers front and finishing back panel 1.8 cm thick



Ante, frontali cassetti e schiene di finitura in effetto pelle sp. 1.8 cm / Leather effect doors, drawers front and finishing back panel 1.8 cm thick

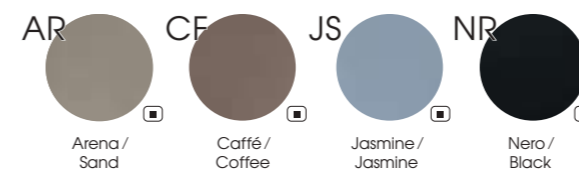

Moduli superiori sp. 1 cm / Wall modules 1 cm thick

Cassetto interno / Internal drawer (Optional)

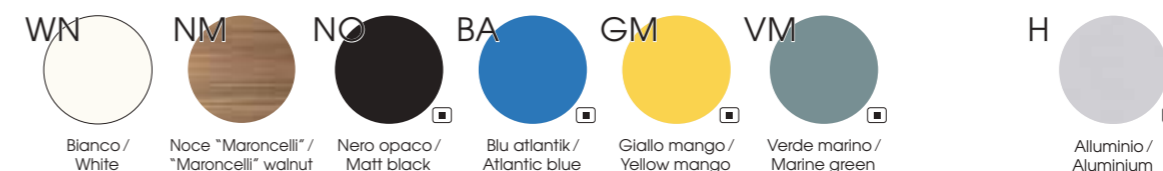

Top Access / Top Access

Barra / Bar

Accessori / Accessories

Vaso / Vase

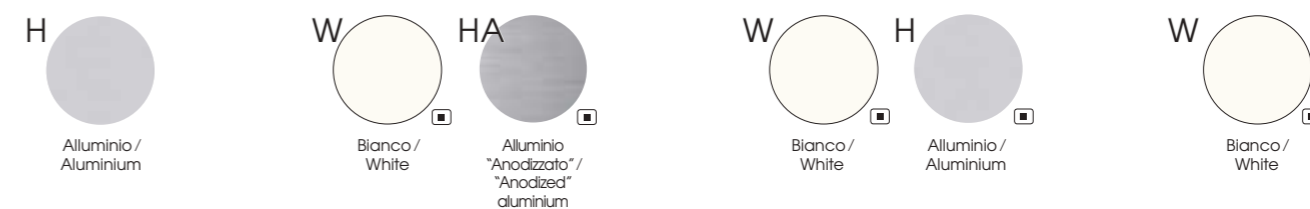

Zoccoli metallici / Metal base frames

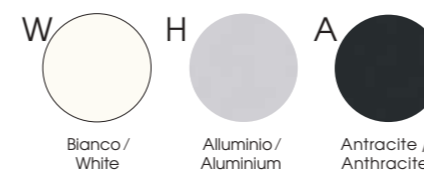

Tavolo scrivania orientabile / Swivel table



Note

Prodotti non in pronta consegna. Per la disponibilità contattare l'ufficio commerciale / Items not in prompt delivery. Please contact the commercial department to check availability

Moduli base a giorno/Open modules

L 60 P 48 x H 40	L 120 P 48 x H 40	L 60 P 48 x H 60	L 120 P 48 x H 60	L 60 P 48 x H 120
504.MG.02.06_	504.MG.02.12_	504.MG.03.06_	504.MG.03.12_	504.MG.06.06_

Moduli base con ante/Modules with doors

L 60 P 50 x H 40	L 120 P 50 x H 40	L 60 P 50 x H 60	L 120 P 50 x H 60	L 60 P 50 x H 120
504.MA.02.06_	504.MA.02.12_	504.MA.03.06_	504.MA.03.12_	504.MA.06.06_

Moduli base con cassetti/Modules with drawers

L 60 P 50 x H 40	L 120 P 50 x H 40	L 60 P 50 x H 60	L 60 P 50 x H 60	L 120 P 50 x H 60
504.MC.02.06_	504.MC.02.12_	504.MC.01.06_	504.MC.03.06_	504.MC.03.12_

Accessori moduli base con cassetti/Accessories for modules with drawers

L 56 P 42 x H 14,5	L 55 P 40 x H 13	L 55 P 40 x H 10
504.CS.01.05 Cassetto Optional interno /Optional internal drawer	504.CS.A6.08 Reggicartella per cassetto H. 40 /Frame for folders for drawers h.40	504.CS.A6.11 Reggicartella per cassetto H. 60 /Frame for folders for drawers h.60

Accessori cassetti/Accessories for drawers

L 33
503.CS.P1.00 L 33
503.CS.P2.00 L 39

Note: Per l'integrazione degli accessori con i moduli con cassetti consultare il manuale tecnico/It is obligatory to integrate at least 1 back panel (internal or internal + external finishing panel) each two columns

Moduli con vano tecnico per integrazione tavoli/Modules with technical compartment for desk integration

L 60 P 50 x H 40	L 60 P 50 x H 40	L 60 P 50 x H 60	L 60 P 50 x H 60	L 60 P 50 x H 60	L 60 P 50 x H 60
504.MV.02.06_	504.MV.02.06_	504.MV.03.06_	504.MV.03.06_	504.MV.01.06_	504.MV.01.06_

Con ante / With door

Moduli superiori/Superior module

L 60 P 48 x H 20	L 120 P 48 x H 20
504.MS.00.06_	504.MS.00.12_

Schiene di finitura/Finishing back panel

P 1.8 x H 40	P 1.8 x H 60	P 1.8 x H 120
504.SC.02.06_ L 60	504.SC.03.06_ L 60	504.SC.06.06_ L 60
504.SC.02.12_ L 120	504.SC.03.12_ L 120	
504.SC.02.18_ L 180	504.SC.03.18_ L 180	

Note:

1 Per la scelta degli accessori vari, consultare il relativo listino o catalogo/To choose accessories, please check correspondent price list or catalogue;

2 Le dimensioni sono espresse in cm - consultare il listino prezzi per le caratteristiche tecniche, i codici degli articoli e delle finiture/Dimensions are stated in cm - for technical characteristics, article code numbers and finishing see price list.

3 Prodotti non in pronta consegna. Per la disponibilità contattare l'ufficio commerciale/items not in prompt delivery. Please contact the commercial department to check availability;

Con serratura/With lock.

Zoccoli/Base frames

P 48 - H 6,1	P 48 - H 26,1
504.ZB.01.12_ L 80	504.ZB.02.12_ L 80
504.ZB.01.18_ L 140	504.ZB.02.18_ L 140
504.ZB.01.24_ L 200	504.ZB.02.24_ L 200
	Compresa coppia carter di copertura /Including pair of covering carter

Canalina per zoccoli / Wire management for base frames

L 115 P 12 - H 2
300.CL.01.40

Modulo pensile/Overhead module

L 60 P 34 x H 30	L 120 P 34 x H 30	L 30 P 34 x H 60	L 60 P 34 x H 60	L 30 P 34 x H 120
504.PG.01.06_	504.PG.01.12_	504.PG.03.03_	504.PG.03.06_	504.PG.06.03_

Note: Pensili integrabili alla barra o a parete/Overhead for integration to bar or wall

Modulo pensile con ante/Overhead module with doors

L 30 P 36 x H 60	L 60 P 36 x H 60	L 30 P 36 x H 120
504.PA.03.03_	504.PA.03.06_	504.PA.06.03_

Note: Pensili integrabili alla barra o a parete/Overhead for integration to bar or wall

Tavolo scrivania orientabile / Swivel desk

L 160 P 50 x H 74
504.TH.00.16_

Note: I tavoli orientabili possono essere integrati solo ai moduli base con ante o cassetti DV504 / N.B.: The swivel desks can only be integrated with the base modules with doors or drawers DV504

Barra/Bar

P 3 x H 11
504.BR.01.18_ L 180
504.BR.01.24_ L 240

Note: Disponibile in versione con o senza LED (EU - UK - US), chiedere all'ufficio commerciale/ Available with or without LED (EU - UK - US), contact the commercial department. Alla barra è possibile integrare gli accessori, i pensili e i tavoli scrivania della serie DV812-DV911/ It is possible to integrate to the bar the accessories, the overhead unit ante the desk tables of DV812-DV911 series

Accessori barra/Accessories for bar

L 20 P 22 x H 20	L 20 P 22 x H 40	Ø 18	L 3 P 4 x H 10	L 3 P 4 x H 20	L 30 P 21 x H 20
504.AC.01.01_	504.AC.01.02_	504.AC.04.01	504.AC.02.01_	504.AC.02.02_	504.AC.03.01_
Porta vasi / Vase Holder	Porta vasi / Vase Holder	Vaso / Vase	Gancio / Hook	Gancio / Hook	Porta Fogli / Paper holder

Note:

1 Per la scelta degli accessori vari, consultare il relativo listino o catalogo/To choose accessories, please check correspondent price list or catalogue;

3 Solo le finiture bianco e noce "Maroncelli" sono in pronta consegna. /Only white and "Maroncelli" walnut finishes are in prompt delivery.

4 Prodotti non in pronta consegna. Per la disponibilità contattare l'ufficio commerciale/items not in prompt delivery. Please contact the commercial department to check availability;

Fino ad esaurimento/Until exhaustion.

2 Le dimensioni sono espresse in cm - consultare il listino prezzi per le caratteristiche tecniche, i codici degli articoli e delle finiture/Dimensions are stated in cm - for technical characteristics, article code numbers and finishing see price list.

Rio

DV505

I "contenitori integrati" permettono di completare e di attrezzare il posto di lavoro, garantendo diverse funzioni tra le quali: ampio spazio per il contenimento e l'archiviazione, utile predisposizione ed efficiente canalizzazione dei cablaggi, possibilità di creare molteplici soluzioni in grado di configurare lo spazio di lavoro con privacy e personalizzazione.

The "integrated storage units" make it possible to complete and equip the workplace, ensuring various functions including: wide space for organization and storage, useful predisposition and efficient wiring of the cables, possibility of creating multiple solutions able to configure the workplace with privacy and customization.









Design pulito e lineare, grande funzionalità sono gli elementi alla base di questo concept, pensato per un'ottimale organizzazione dell'ufficio.

Clean design and linear, great functionality are the elements to the basis of this concept, thought for an optimal organization of the office.





Contenitori / Storage units

Scocche e mensole sp. 1.8 cm, in melaminico / Bodies and shelves 1.8 cm thick, in melamine



Ante e frontali cassetti sp. 1.8 cm, in melaminico con bordo ABS sp. 0.15 cm colore alluminio / Doors and drawers fronts 1.8 cm thick, in melamine with aluminium-coloured ABS edge-profiles 0.15 cm thick

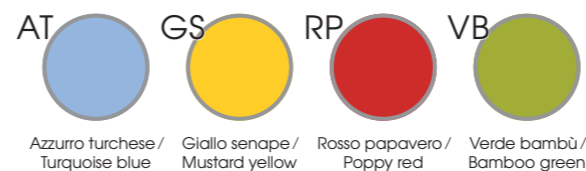

Ante e frontali cassetti sp. 1.8 cm, in melaminico con bordo ABS sp. 0.15 cm in tinta / Doors and drawers fronts 1.8 cm thick, in melamine with ABS edge-profiles 0.15 cm thick, in same color



Top Orgatower / Orgatower Top

Sp. 1.8 cm, in melaminico / 1.8 cm thick, in melamine



Maniglie / Handles

Q - V - T

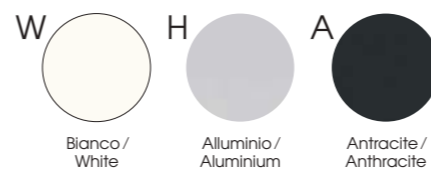

XBR

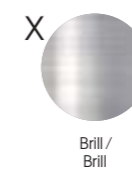









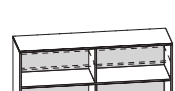

Interasse 96 mm / Interasse 128 mm / Interasse 256 mm / Interasse 256 mm / Interasse 96 mm /
96 mm Centers 128 mm Centers 256 mm Centers 256 mm Centers 96 mm Centers



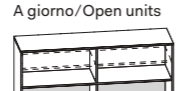

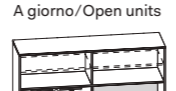

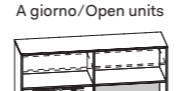



Moduli contenitori integrati L 166,5 P 48 x H 74/Integrated storage unit W 166,5 D 48 x H 74

  505.CI.01.16.11_ 2 vani attrezzabili /2 equipppable compartments	  505.CI.02.16.11_ 1 vano attrezzabile e supporto scrivania/1 equipppable compartment and bracket for desk	  Sx/L - Dx/R 505.CI.03.16.11_ 1 vano attrezzabile, canalizzazione e supporto scrivania/1 equipppable compartment, wire management and bracket for desk
--	---	---

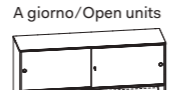

Moduli contenitori integrati L 166,5 P 48 x H 115 / Integrated storage unit W 166,5 D 48 x H 115

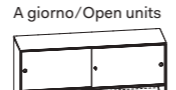
  505.CI.01.16.31_ 2 vani attrezzabili /2 equipppable compartments	  505.CI.02.16.31_ 1 vano attrezzabile e supporto scrivania/1 equipppable compartment and bracket for desk	  Sx/L - Dx/R 505.CI.03.16.31_ 1 vano attrezzabile, canalizzazione e supporto scrivania/1 equipppable compartment, wire management and bracket for desk	  A giorno/Open units 505.CI.04.16.31_ 2 vani attrezzabili /2 equipppable compartments	  A giorno/Open units 505.CI.05.16.31_ 1 vano attrezzabile e supporto scrivania/1 equipppable compartment and bracket for desk	  Sx/L - Dx/R 505.CI.06.16.31_ 1 vano attrezzabile, canalizzazione e supporto scrivania/1 equipppable compartment, wire management and bracket for desk
--	---	---	---	--	---

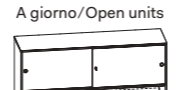
Moduli contenitori integrati L 166,5 P 48 x H. 164,5/Integrated storage unit W 166,5 D 48 x H 164,5

  505.CI.01.16.41_ 2 vani attrezzabili /2 equipppable compartments	  505.CI.02.16.41_ 1 vano attrezzabile e supporto scrivania/1 equipppable compartment and bracket for desk	  Sx/L - Dx/R 505.CI.03.16.41_ 1 vano attrezzabile, canalizzazione e supporto scrivania/1 equipppable compartment, wire management and bracket for desk	  A giorno/Open units 505.CI.04.16.41_ 2 vani attrezzabili /2 equipppable compartments	  A giorno/Open units 505.CI.05.16.41_ 1 vano attrezzabile e supporto scrivania/1 equipppable compartment and bracket for desk	  Sx/L - Dx/R 505.CI.06.16.41_ 1 vano attrezzabile, canalizzazione e supporto scrivania/1 equipppable compartment, wire management and bracket for desk
--	---	---	---	--	---

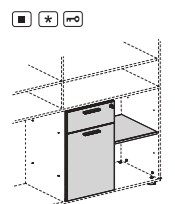

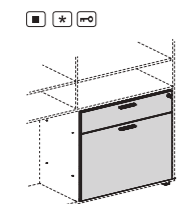
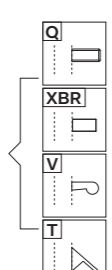

Cassettiere per contenitori/Drawers for storage units

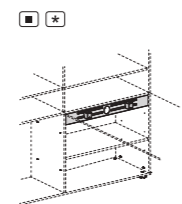
  L 80 P 45 x H 67,5 505.EC.01.04_ N.B.: il ripiano è compreso / N.B.: The shelf is included	  L 80 P 45 x H 67,5 505.EC.01.08_ 
--	--

Supporto tavoli scrivania integrabili/Bracket for desk integration

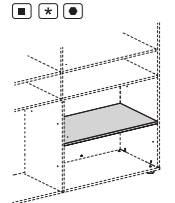
  L 80 505.ES.01.08 Note: È possibile integrare ai contenitori con supporto scrivania le serie DV801-DV802. Per l'integrazione con i tavoli DV812 vedi relativo catalogo/DV801-DV802 series can be integrated to the storage unit with desk support bracket. For the integration with DV812 tables see relative catalog.
--

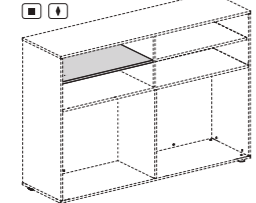

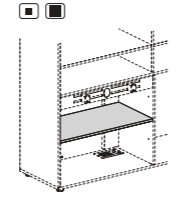

Mensole/Shelf

  L 80 P 45 x H 1,8 505.EM.01.08_	  L 80 P 45 x H 1,8 505.EM.02.08_	  L 80 P 43 x H 1,8 505.EM.03.08_
--	--	--

Note:

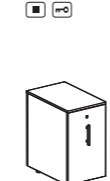
- 1 Per la scelta degli accessori vari, consultare il relativo listino o catalogo/To choose accessories, please check correspondent price list or catalogue;
- 2 Le dimensioni sono espresse in cm - consultare il listino prezzi per le caratteristiche tecniche, i codici degli articoli e delle finiture/Dimensions are stated in cm - for technical characteristics, article code numbers and finishing see price list;
- 3 Per l'integrazione con i tavoli DV812 vedi relativo catalogo / For the integration with DV812 tables see relative catalog
- * Vano attrezzabile 1° livello/Equipppable compartment first level;
- Vano attrezzabile 1° livello con supporto per integrazione scrivanie/Equipppable compartment first level with bracket for desk integration;
- Vano attrezzabile 1° livello con supporto per integrazione scrivanie e canalizzazione/Equipppable compartment first level with bracket for desk integration and cable management;
- Vano attrezzabile 2° livello/Equipppable compartment second level;
- Tutti gli articoli della serie DV505 - RIO non sono in pronta consegna. Per la disponibilità contattare l'ufficio commerciale/All the items of the DV505 - RIO series are not in prompt delivery. Please contact the commercial department to check availability.
- ☞ Con serratura/With lock.

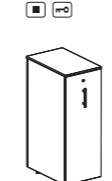

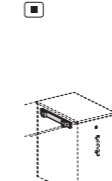

Orgatower P 65/Orgatower P 65

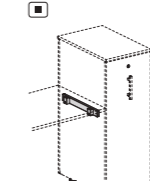
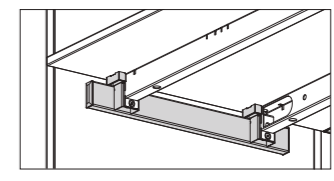
  L 42 P 65 x H 74 505.TW.01.02_ Sx/L - Dx/R	  L 42 P 65 x H 115 505.TW.03.02_ Sx/L - Dx/R	  505.CG.07.07_ ☞
--	---	--

Supporti per tavoli su Orgatower P 65/Brackets for desks on Orgatower P 65

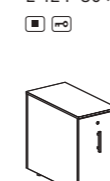
  505.CG.07.07_ ☞	 Note: È possibile integrare agli orgatowers con supporto scrivania le serie DV801-DV802. Per l'integrazione della serie DV812, consultare il relativo listino o catalogo./DV801-DV802 series can be integrated to the orgatowers with desk support bracket. For the integration of DV812 serie, please check correspondent price list or catalogue;
--	--

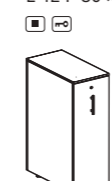
Orgatower P 80/Orgatower P 80

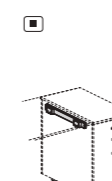
  L 42 P 80 x H 74 505.TW.01.03_ Sx/L - Dx/R	  L 42 P 80 x H 115 505.TW.03.03_ Sx/L - Dx/R	  505.CG.07.08_ ☞
--	---	--

Supporti per tavoli su Orgatower P 80/Brackets for desks on Orgatower P 80

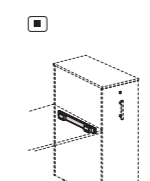
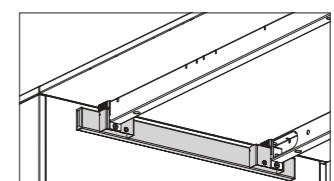
  505.CG.07.08_ ☞	 Note: È possibile integrare agli orgatowers con supporto scrivania le serie DV801-DV802. Per l'integrazione della serie DV812, consultare il relativo listino o catalogo./DV801-DV802 series can be integrated to the orgatowers with desk support bracket. For the integration of DV812 serie, please check correspondent price list or catalogue;
--	--

Note:

- 1 Per la scelta degli accessori vari, consultare il relativo listino o catalogo/To choose accessories, please check correspondent price list or catalogue;
- 2 Le dimensioni sono espresse in cm - consultare il listino prezzi per le caratteristiche tecniche, i codici degli articoli e delle finiture/Dimensions are stated in cm - for technical characteristics, article code numbers and finishing see price list;
- 3 Per l'integrazione con i tavoli DV812 vedi relativo catalogo / For the integration with DV812 tables see relative catalog
- ☞ Con serratura/With lock.
- Tutti gli articoli della serie DV505 - RIO non sono in pronta consegna. Per la disponibilità contattare l'ufficio commerciale/All the items of the DV505 - RIO series are not in prompt delivery. Please contact the commercial department to check availability.

Roma

DV522

Le librerie ad "ante scorrevoli" sono caratterizzate dalle molteplici combinazioni cromatiche e formali che si possono configurare grazie alla varietà di ante in melaminico o in vetro.

Several colour and shape combinations are possible with these bookshelves, through a variety of melamine and glass finished "sliding doors".







Variazioni
geometriche, spazi
pieni e vuoti e
inediti accostamenti
cromatici.

*Geometric
variations, full
and empty spaces
and unprecedented
color combinations.*



Contenitori / Storage units

Scocca e ripiani sp. 3 cm, in melaminico / Body and shelves 3 cm thick, in melamine



Ante scorrevoli sp. 1 cm e Top (Optional) sp. 1.8 cm, in melaminico / Sliding doors 1 cm thick and Top (Optional) 1.8 cm thick, in melamine



Ante scorrevoli sp. 0.5 cm, in vetro temprato / Sliding doors 0.5 cm thick, tempered glass



Ante scorrevoli sp. 1.2 cm, in cuoio con cuciture / Sliding doors 1.2 cm thick, in leather with stitches

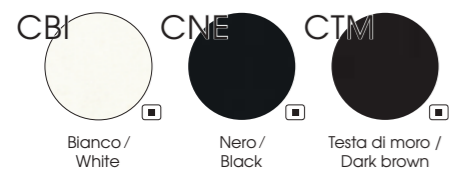

Note

■ Prodotti non in pronta consegna. Per la disponibilità contattare l'ufficio commerciale / Items not in prompt delivery. Please contact the commercial department to check availability.

Librerie ante scorrevoli / Bookshelves with sliding doors

L 180 P 34,5 x H 170

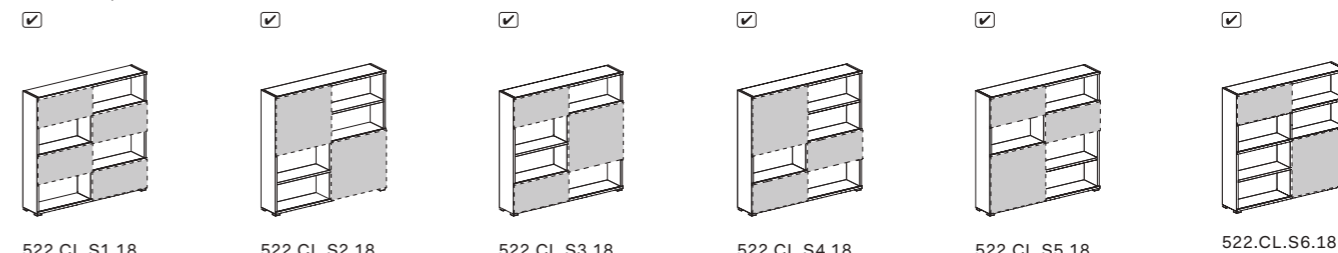

L 180 P 34,5 x H 170

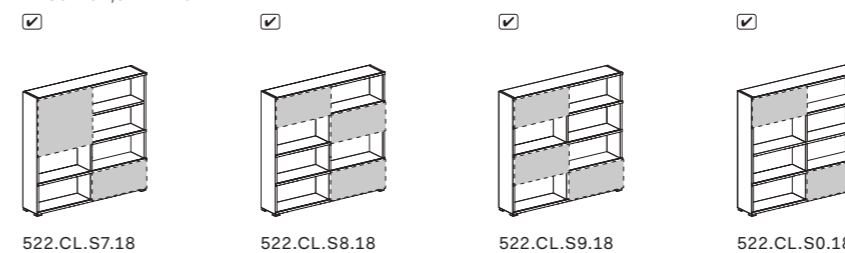

L 180 P 34,5 x H 88,2

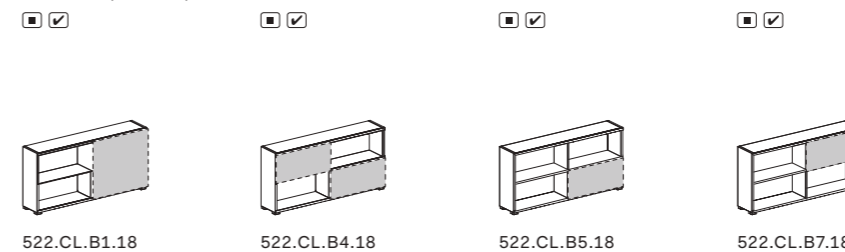

Ante scorrevoli in melaminico / Melamine sliding doors

L 90 P 1 x H 40,5



522.CL.A4.09_

L 90 P 1 x H 81,5

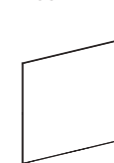

522.CL.A8.09_

Ante scorrevoli in vetro / Glass sliding doors

L 90 P 0,5 x H 40,5



522.CL.V4.09

L 90 P 0,5 x H 81,5



522.CL.V8.09

Ante scorrevoli in cuoio / Leather sliding doors

L 90 P 1,2 x H 40,5

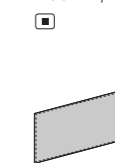

522.CL.P4.09_

L 90 P 1,2 x H 81,5

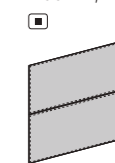

522.CL.P8.09_

Top (Optional)

L 180 P 36,3 x H 1,8



522.CU.TA.18_

Note:

① Le dimensioni sono espresse in cm - consultare il listino prezzi per le caratteristiche tecniche, i codici degli articoli e delle finiture / Dimensions are stated in cm - for technical characteristics, article code numbers and finishing see price list;

② Le finiture cuoio non sono in pronta consegna. Per la disponibilità contattare l'ufficio commerciale / Leather finishes are not in prompt delivery. Please contact the commercial department to check availability;

✓ Le ante rappresentate nelle librerie non sono comprese nei codici di vendita e quindi sono da ordinare a parte, scegliendole tra quelle in melaminico, vetro o cuoio (H 40,5 o H 81,5) come indicato nella composizione da realizzare / The doors shown on the bookshelves are not included in our sales code numbers, therefore they need to be ordered separately, choosing from the melamine, glass or leather finishes (H 40,5 or H 81,5) as indicated in the composition to be created;

■ Prodotti non in pronta consegna. Per la disponibilità contattare l'ufficio commerciale / Items not in prompt delivery. Please contact the commercial department to check availability.

Riga

DV525

La libreria componibile realizzata in melaminico, grosso spessore, può essere posizionata a parete o in centro stanza. Possibilità di molteplici abbinamenti cromatici fra scocche, ante e schiene nelle diverse finiture disponibili.

The modular library made in melamine, important thickness, which can be placed against the wall or in the middle of the room. Possibility of multiple color combinations between body, doors and back panels in the different finishes available.







Contenitori / Storage units

Struttura portante sp. 3.8 cm, in melaminico con bordi perimetrali in ABS nei lati in vista sp. 0.15 cm / Carrying structure 3.8 cm thick, in melamine with 0.15 cm ABS profiles on visible edges



Schiene e ante sp.1.8 cm, in laminato con bordi perimetrali in ABS sp. 0.15 cm in tinta / Back panels and doors 1.8 cm thick, in laminate with 0.15 cm ABS edge-profiles, in same color



Schiene e ante sp.1.8 cm, in melaminico con bordi perimetrali in ABS sp. 0.15 cm colore bianco / Back panels and doors 1.8 cm thick, in melamine with white-coloured 0.15 cm ABS edge-profiles

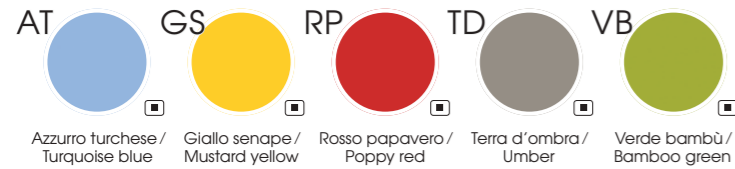

Schiene e ante sp.1.8 cm, in melaminico con bordi perimetrali in ABS sp. 0.15 cm in tinta / Back panels and doors 1.8 cm thick, in melamine with 0.15 cm ABS edge-profiles, in same color

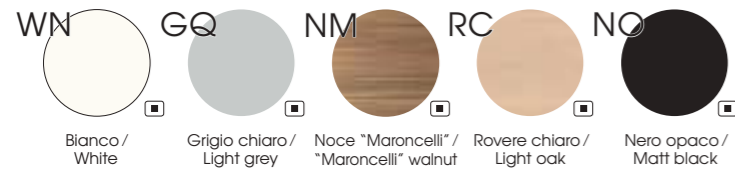

Note:
 □ Prodotti non in pronta consegna. Per la disponibilità contattare l'ufficio commerciale / Items not in prompt delivery. Please contact the commercial department to check availability.

Scocca / Body

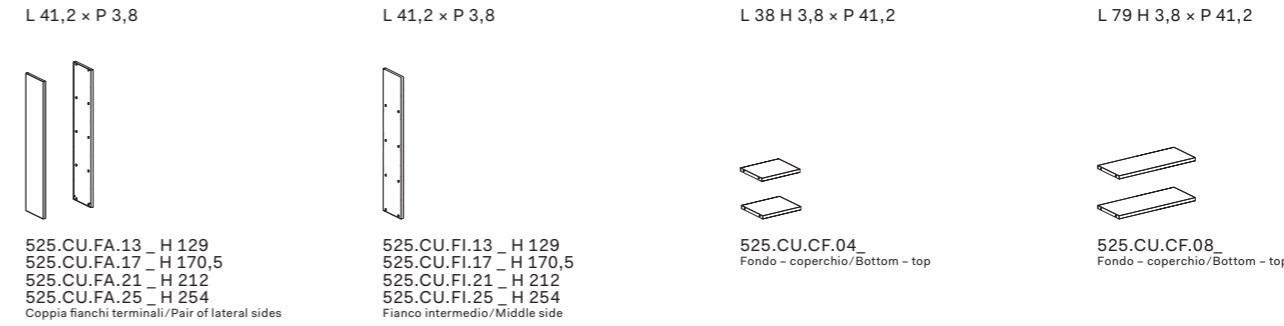

Note: N.B.: sulla scocca non sono presenti fori o pre-fori. Per il montaggio di ante, push-pull e schiene è necessario acquistare la dima. / N.B.: Drills or pre-drills are not present on the body. For assembly of doors, push-pull and back panels, it is necessary to order the drilling tool.

Ripiani L 38 / Shelves W 38

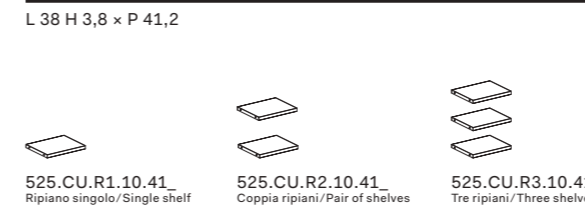

Ripiani L 79 / Shelves W 79



Dima / Drilling template

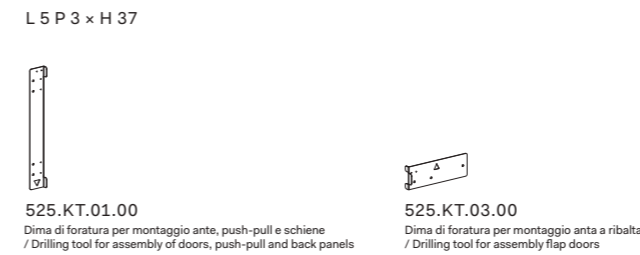

Canalizzazione / Wire management

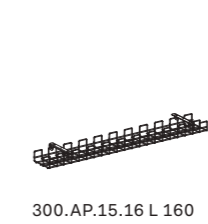

Ante / Doors

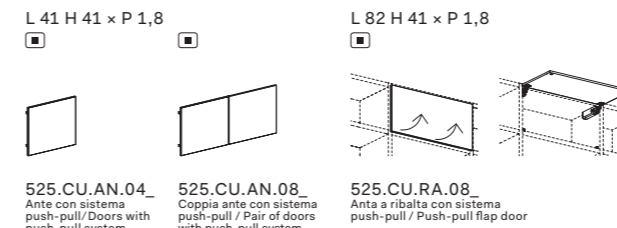

Schiene interne / Inner back panel

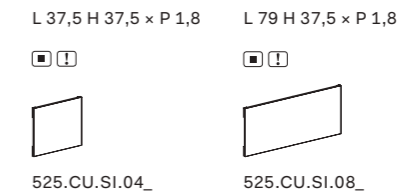

Schiene esterne / Outer back panel

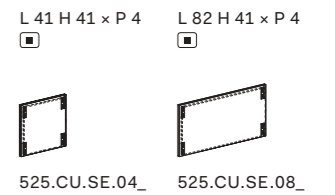

Note: È obbligatorio integrare alle librerie componibili almeno 1 schiena (interna o interna + esterna di finitura) per ogni due colonne / It is obligatory to integrate at least 1 back panel (internal or internal + external finishing panel) each two columns

Esempio di composizione H 212 / Composition example H212

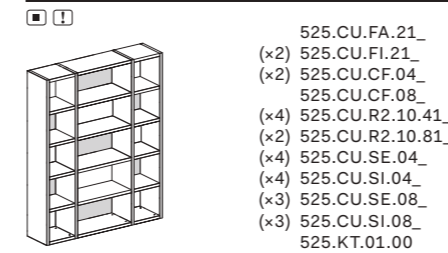

Note:

1 Le dimensioni sono espresse in cm - consultare il listino prezzi per le caratteristiche tecniche, i codici degli articoli e delle finiture / Dimensions are stated in cm - for technical characteristics, article code numbers and finishing see price list;
 □ Prodotti non in pronta consegna. Per la disponibilità contattare l'ufficio commerciale / Items not in prompt delivery. Please contact the commercial department to check availability;

1 Le librerie con solo schiene interne vanno sempre fissate a muro. E' obbligatorio fissare a muro le librerie con altezza superiore a 175 cm - 69" per evitare il ribaltamento. Il sistema di ancoraggio a pavimento o a soffitto per le librerie posizionate a centro stanza non è previsto a listino, è quindi a carico del cliente; / Bookshelves with only internal back panels need to be fixed to the wall. It is obligatory to fix against the wall the libraries higher than 175 cm - 69", in order to prevent tipping. The fixing mechanism to the floor or ceiling for libraries positioned in the middle of the room, is not provided in the Price List, it is at client's expense.

Taba

DV527

Libreria metallica a moduli disponibili in diverse altezze nei colori antracite e bianco. Realizzata con tubolari in alluminio a sezione quadrata e collegati mediante giunti in zama. Leggera e minimale permette di realizzare soluzioni contemporanee e di tendenza assicurando la massima funzionalità.

Metal bookcase with modules, available in different heights, in anthracite or white color. Made of squared aluminum tubes, connected by zamak joints. Light and minimal design, allows to create a contemporary and trendy solution ensuring maximum functionality.







Libreria componibile/Modular bookshelf

Struttura in metallo verniciato con tubolari sezione quadrata, 2x2 cm /
Painted metal structure composed of 2x2 cm thick square tubes



Vaschette - Fioriere / Tray - Planter



Note

▣ Prodotti non in pronta consegna. Per la disponibilità contattare l'ufficio commerciale / Items not in prompt delivery. Please contact the commercial department to check availability

Moduli singoli/Single modules

L 40 P 40 x H 40 ■	L 40 P 40 x H 78 ■	L 40 P 40 x H 116 ■	L 40 P 40 x H 154 ■	L 40 P 40 x H 192 ■
527.CU.MS.04.11_	527.CU.MS.04.21_	527.CU.MS.04.31_	527.CU.MS.04.41_	527.CU.MS.04.51_

Moduli terminali/Terminal modules (A)

L 40 P 40 x H 40 ■	L 40 P 40 x H 78 ■	L 40 P 40 x H 116 ■	L 40 P 40 x H 154 ■	L 40 P 40 x H 192 ■
527.CU.MT.04.11_	527.CU.MT.04.21_	527.CU.MT.04.31_	527.CU.MT.04.41_	527.CU.MT.04.51_

Moduli Intermedi/Middle modules (B)

L 38 P 40 x H 40 ■	L 38 P 40 x H 78 ■	L 38 P 40 x H 116 ■	L 38 P 40 x H 154 ■	L 38 P 40 x H 192 ■
527.CU.MI.04.11_	527.CU.MI.04.21_	527.CU.MI.04.31_	527.CU.MI.04.41_	527.CU.MI.04.51_

Moduli terminali aperti/Open terminal modules (C)

L 38 P 40 x H 40 ■	L 38 P 40 x H 78 ■	L 38 P 40 x H 116 ■	L 38 P 40 x H 154 ■	L 38 P 40 x H 192 ■
527.CU.MA.04.11_	527.CU.MA.04.21_	527.CU.MA.04.31_	527.CU.MA.04.41_	527.CU.MA.04.51_

Moduli singoli/Single modules

L 80 P 40 x H 40 ■	L 80 P 40 x H 78 ■	L 80 P 40 x H 116 ■	L 80 P 40 x H 154 ■	L 80 P 40 x H 192 ■
527.CU.MS.08.11_	527.CU.MS.08.21_	527.CU.MS.08.31_	527.CU.MS.08.41_	527.CU.MS.08.51_

Note:

① Le dimensioni sono espresse in cm - consultare il listino prezzi per le caratteristiche tecniche, i codici degli articoli e delle finiture/Dimensions are stated in cm - for technical characteristics, article code numbers and finishing see price list;

■ Tutti gli articoli della serie DV527 - TABA non sono in pronta consegna. Per la disponibilità contattare l'ufficio commerciale /All the items of the DV527 - TABA series are not in prompt delivery. Please contact the commercial department to check availability.

Moduli terminali/Terminal modules (A)

L 80 P 40 x H 40 ■	L 80 P 40 x H 78 ■	L 80 P 40 x H 116 ■	L 80 P 40 x H 154 ■	L 80 P 40 x H 192 ■
527.CU.MT.08.11_	527.CU.MT.08.21_	527.CU.MT.08.31_	527.CU.MT.08.41_	527.CU.MT.08.51_

Moduli Intermedi/Middle modules (B)

L 78 P 40 x H 40 ■	L 78 P 40 x H 78 ■	L 78 P 40 x H 116 ■	L 78 P 40 x H 154 ■	L 78 P 40 x H 192 ■
527.CU.MI.08.11_	527.CU.MI.08.21_	527.CU.MI.08.31_	527.CU.MI.08.41_	527.CU.MI.08.51_

Moduli terminali aperti/Open terminal modules (C)

L 78 P 40 x H 40 ■	L 78 P 40 x H 78 ■	L 78 P 40 x H 116 ■	L 78 P 40 x H 154 ■	L 78 P 40 x H 192 ■
527.CU.MA.08.11_	527.CU.MA.08.21_	527.CU.MA.08.31_	527.CU.MA.08.41_	527.CU.MA.08.51_

Kit di fissaggio a muro /Kit for wall fixing

■
527.KT.01.00_

Esempio di composizione/Composition example

L 80 x P 40 ■	L 80 x P 80 ■
527.CU.MT.04.41_ (A) 527.CU.MI.04.41_ (B) 527.CU.MA.04.41_ (C)	527.CU.MT.08.41_ (A) 527.CU.MI.08.41_ (B) 527.CU.MA.08.41_ (C)

Nelle composizioni con moduli con la stessa altezza, esternamente utilizzare 1 modulo terminale (A) ed 1 modulo terminale aperto (C) /In the compositions with modules with the same height, externally use 1 terminal module (A) and 1 open terminal module (C)

Vaschette - fioriere/Tray - planter

L 35 P 35 x H 15 ■	L 75 P 35 x H 15 ■	L 35 P 35 x H 35 ■	L 75 P 35 x H 35 ■	L 35 P 35 x H 76 ■
527.VA.01.01_	527.VA.01.02_	527.VA.02.01_	527.VA.02.02_	527.VA.03.01_

Note: Solo per moduli H 78 cm / Only for module H: 30 3/4"

Esempio di composizione/Composition example

■	■
527.CU.MT.08.21_ (A) 527.CU.MA.04.21_ (C) 527.VA.03.01_	527.CU.MT.04.51_ (A) 527.CU.MI.08.51_ (B) 527.CU.MA.04.51_ (C) 527.VA.01.01_

Note:

① Le dimensioni sono espresse in cm - consultare il listino prezzi per le caratteristiche tecniche, i codici degli articoli e delle finiture/Dimensions are stated in cm - for technical characteristics, article code numbers and finishing see price list;

■ Tutti gli articoli della serie DV527 - TABA non sono in pronta consegna. Per la disponibilità contattare l'ufficio commerciale /All the items of the DV527 - TABA series are not in prompt delivery. Please contact the commercial department to check availability.

⊞ Per le finiture RO - AP - VS la quantità minima per ogni dimensione e ogni colore è di 6 pezzi / For the finishes RO - AP - VS the minimum quantity for each size and each colour is 6 pieces.

Boiserie

DV530

Eleganti e di forte impatto estetico, le "boiserie" per ufficio permettono di completare con stile qualsiasi ambiente di lavoro. Disponibili in due altezze nelle diverse finiture, si abbinano alle diverse serie di scrivanie proposte a catalogo.

The "boiseries" are elegant and of strong esthetical impact and furnish with style any working environment. Available in two heights and several finishes, they match the executive desks proposed in our catalogues.





Le boiserie possono essere accostate tra di loro o sovrapposte sui contenitori; le mensole sono disponibili in vetro acidato.

The boiserie can be placed side by side or superimposed on the containers; the shelves are available in etched glass.



Pannelli boiserie / Boiserie panels

Pannelli sp. 1.8 cm, in melaminico o laminato / Panels 1.8 cm thick, in melamine or laminate



Mensole vetro / Glass shelves

Mensole sp. 0.8 cm, in vetro temprato / Shelves 0.8 cm thick, tempered glass



Profili e zoccoli / Profiles and base frames



Note

Prodotti non in pronta consegna. Per la disponibilità contattare l'ufficio commerciale / Items not in prompt delivery. Please contact the commercial department to check availability.

Boiserie

L 180 P 1,8 x H 207,5



530.CB.TR.18_

L 180 P 1,8 x H 123

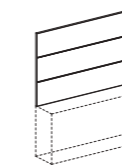

530.CB.SP.18_

L 179 P 24 x H 0,8

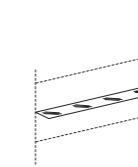

530.CB.RV.18_

L 180 P 24,5 x H 207,5

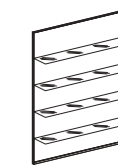

530.CB.T1.18_

L 180 P 24,5 x H 123

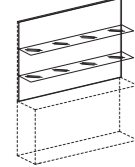

530.CB.S1.18_

Esempi di composizione / Examples of composition

L 180 P 45 x H 207,5

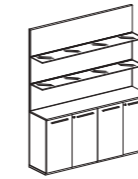

L 270 P 45 x H 209,3

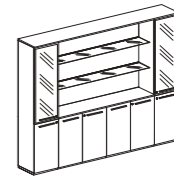
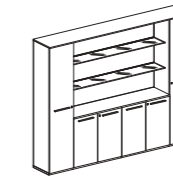
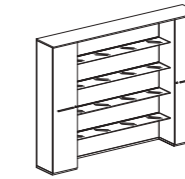

Note:

Le dimensioni sono espresse in cm - consultare il listino prezzi per le caratteristiche tecniche, i codici degli articoli e delle finiture / Dimensions are stated in cm - for technical characteristics, article code numbers and finishing see price list:

Seul

DV545

Disponibili in diverse tipologie dimensionali, completano ed arricchiscono la famiglia dei prodotti destinati all'archiviazione. La loro concreta funzionalità e il loro stile universale permettono di realizzare ambienti versatili e moderni, all'insegna dell'essenzialità e della tecnicità.

Available in different dimensions; they complete and enrich the range of items dedicated to archiving. Their practical functionality and universal style allow the creation of modern and versatile environments, dedicated to essentiality and technicality.







In evidenza la qualità, la pulizia formale di scocche e ante dotate di un efficiente e ricercato sistema di scorrimento su binario con apertura-chiusura "soft-closing".

The key elements are the quality, the clean lines of bodies and doors, that are equipped with an efficient and sophisticated "soft-opening and closing" rail system.



Contenitori / Storage units

Scocca sp. 1.8 cm, in melaminico / Body 1.8 cm thick, in melamine



Ante scorrevoli sp. 1.8 cm, in melaminico con bordo ABS sp. 0.15 cm colore alluminio / Sliding doors 1.8 cm thick, in melamine with aluminium-coloured ABS edge-profiles 0.15 cm thick

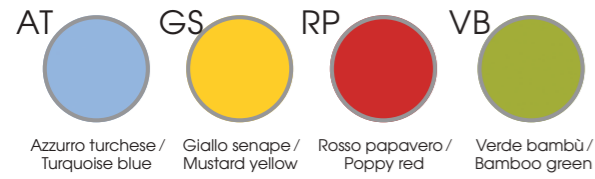

Ante scorrevoli sp. 1.8 cm, in melaminico con bordo ABS sp. 0.15 cm in tinta / Sliding doors 1.8 cm thick, in melamine with ABS edge-profiles 0.15 cm thick, in same color

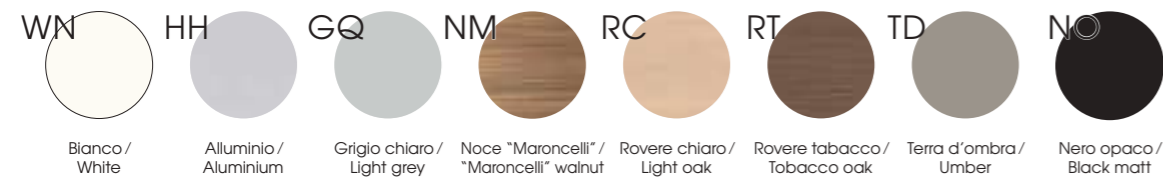

Contenitori ante scorrevoli / Sliding doors storage units

P 40,5 x H 74



545.CA.S1.13_L 136,5
 545.CA.S1.16_L 166,5

P 40,5 x H 115

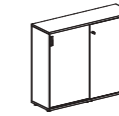

545.CA.S2.13_L 136,5
 545.CA.S2.16_L 166,5

P 40,5 x H 164,5

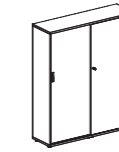

545.CA.S3.13_L 136,5
 545.CA.S3.16_L 166,5

Zoccoli metallici / Metal base frames

P 40,5 x H 2,8

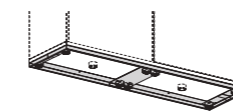

545.ZZ.01.13 L 136,5
 545.ZZ.01.16 L 166,5

Note:

Le dimensioni sono espresse in cm - consultare il listino prezzi per le caratteristiche tecniche, i codici degli articoli e delle finiture/Dimensions are stated in cm - for technical characteristics, article code numbers and finishing see price list;

Tutti gli articoli della serie DV545 - Ante scorrevoli non sono in pronta consegna. Per la disponibilità contattare l'ufficio commerciale/All the items of the DV545 - Sliding doors series are not in prompt delivery. Please contact the commercial department to check availability;

Con serratura/With lock.

Lockers DV549

Pratici e utili contenitori destinati a diversi ambienti di lavoro in cui si presenta la necessità di contenere o custodire documenti ed effetti personali. Modulari e componibili, essi si possono adattare secondo le svariate richieste del cliente.

Practical and useful storage units for different working environments where the keeping or warding of documents and personal belongings is needed. Modular units, adaptable to various needs of each customer.







Attuali, freschi, giocosi, diventano eleganti e riconoscibili soprattutto nelle versioni con le ante colorate: disponibili con serrature in diverse tipologie e con numeri integrabili.

Topical, fresh, playful, they become elegant and recognizable especially in the version with coloured doors, available with different types of locks and possibility of integrating numbers.



Contenitori / Storage units

Scocca, ripiani e top sp. 1.8 cm, in melaminico / Body, shelves, top 1.8 cm thick, in melamine

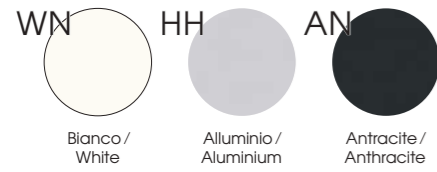

Ante sp.1.8 cm, in melaminico con bordi perimetrali in ABS sp. 0.15 cm colore bianco / Doors 1.8 cm thick, in melamine with white-coloured 0.15 cm ABS edge-profiles

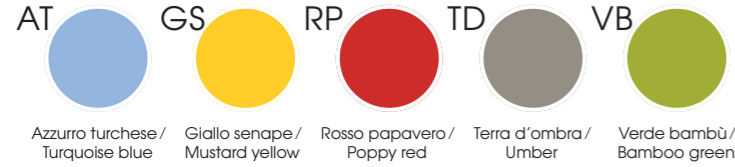

Ante sp. 1.8 cm, in melaminico con bordo ABS sp. 0.15 cm in tinta / Doors 1.8 cm thick, in melamine with ABS edge-profiles 0.15 cm thick, in same color

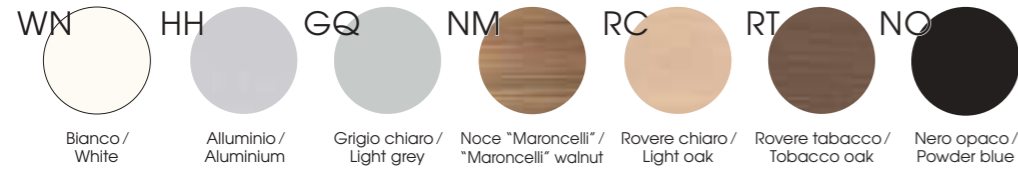

Lockers

L 48,5 P 45 x H 142,8	L 46,8 P 45 x H 142,8	L 48,5 P 45 x H 189,6	L 46,8 P 45 x H 189,6	L 142,3 P 45 x H 142,8	L 189 P 45 x H 189,6	P 45 x H 1,8
549.LK.11.04_ Modulo terminale per 3 ante /Terminal module for 3 doors	549.LK.12.04_ Modulo centrale per 3 ante /Central module for 3 doors	549.LK.13.04_ Modulo terminale per 4 ante /Terminal module for 4 doors	549.LK.14.04_ Modulo centrale per 4 ante /Central module for 4 doors	549.CL.K3.14_ Moduli / Module 3x3	549.CL.K4.18_ Moduli / Module 4x4	549.TK.01.04_ L 48,7 (Per 1 ante/For 1 door) 549.TK.01.09_ L 95,5 (Per 2 ante/For 2 doors) 549.TK.01.13_ L 142,3 (Per 3 ante/For 3 doors) 549.TK.01.18_ L 189 (Per 4 ante/For 4 doors) 549.TK.01.22_ L 236 (Per 5 ante/For 5 doors) 549.TK.01.27_ L 282,8 (Per 6 ante/For 6 doors)

Note: Per l'integrazione dei TOP vedi "Manuale Tecnico"/Check the "Technical book" for the integration of TOP

Ante / Doors

L 45 P 1,8 x H 45							
549.AN.11.04_ Con serratura a chiave /With lock	549.AN.13.04_ Con serratura a chiave e foro per 1 numero /With lock and set up for 1 number	549.AN.15.04_ Con serratura a chiave e fori per 2 numeri /With lock and set up for 2 numbers	549.AN.17.04_ Con serratura a chiave e fori per 3 numeri /With lock and set up for 3 numbers	549.AN.12.04_ Con serratura a combinazione /With lock and combination	549.AN.14.04_ Con serratura a combinazione e foro per 1 numero /With lock and combination, set up for 1 number	549.AN.16.04_ Con serratura a combinazione e fori per 2 numeri /With lock and combination, set up for 2 numbers	549.AN.18.04_ Con serratura a combinazione e fori per 3 numeri /With lock and combination, set up for 3 numbers

N Numeri da aggiungere all'ordine /Numbers to be added to the order

Ante con feritoia passacarte e ripiano / Doors with paper slot and shelf

L 45 P 43 x H 45							
549.AN.21.04_ Con serratura a chiave /With lock	549.AN.23.04_ Con serratura a chiave e foro per 1 numero /With lock and set up for 1 number	549.AN.25.04_ Con serratura a chiave e fori per 2 numeri /With lock and set up for 2 numbers	549.AN.27.04_ Con serratura a chiave e fori per 3 numeri /With lock and set up for 3 numbers	549.AN.22.04_ Con serratura a combinazione /With lock and combination	549.AN.24.04_ Con serratura a combinazione e foro per 1 numero /With lock and combination, set up for 1 number	549.AN.26.04_ Con serratura a combinazione e fori per 2 numeri /With lock and combination, set up for 2 numbers	549.AN.28.04_ Con serratura a combinazione e fori per 3 numeri /With lock and combination, set up for 3 numbers

N Numeri da aggiungere all'ordine /Numbers to be added to the order

Accessori / Accessories

549.N0.0	549.N0.1	549.N0.2	549.N0.3	549.N0.4	549.N0.5	549.N0.6	549.N0.7	549.N0.8	549.N0.9
549.AC.PI.01 Piedini con livellatore in ABS/ABS Feet (Optional)	549.CU.A4.00 Chiave passapartout per ante con serratura con combinazione / Passe-partout key for door with lock and combination								

Note:

Le dimensioni sono espresse in cm - consultare il listino prezzi per le caratteristiche tecniche, i codici degli articoli e delle finiture / Dimensions are stated in cm - for technical characteristics, article code numbers and finishing see price list; Tutti gli articoli della serie DV549-LOCKERS non sono in pronta consegna. Per la disponibilità contattare l'ufficio commerciale / All the items of the DV549-LOCKERS series are not in prompt delivery. Please contact the commercial department to check availability; Con serratura / With lock.

Pedestals

DV550

Le "Cassettiere universali" da ufficio sono disponibili in versione metallo, melaminico e laminato. Possibilità di specifici accessori per l'attrezzatura dei cassetti interni.

The "Universal pedestals" for office are available in metal, melamine and laminate versions. Possibility of specific accessories for the equipment of the internal drawers.







I mobili di servizio su ruote svolgono molteplici funzioni; sono disponibili nelle finiture melaminico e laminato.

Service units on castors perform multiple functions; they are available in melamine and laminate finishes.





Cassettiere in melaminico (*) o laminato (**)/ Pedestals in melamine (*) or laminate (**)



Cassettiere metalliche / Metal pedestals

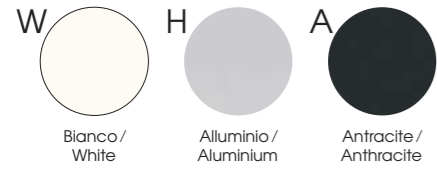

Cassettiere portanti 4 cassetti o 3 cassetti in melaminico / Carrying pedestals in melamine with 4 drawers or 3 drawers



Top. sp. 1.8 - 2.5 - 3.8 cm, in melaminico / Top. 1.8 - 2.5 - 3.8 cm thick, in melamine



Zoccoli in alluminio / Aluminium plinth



Cuscini / Cushion

Rivestimento in tessuto 100% poliestere Trevira CS - JET Bioactive / 100% polyester Trevira CS - JET Bioactive fabric coating

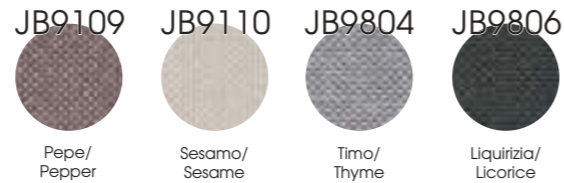

Mobili di servizio su ruote / Service units on castors

Cappello, ante e frontali cassetti sp. 1.8 cm, in melaminico (*) o laminato (**)/ Top, doors and drawer fronts 1.8 cm thick, in melamine (*) or laminate (**)



Scocca in melaminico colore alluminio / Melamine body in aluminium finish



Note

Prodotti non in pronta consegna. Per la disponibilità contattare l'ufficio commerciale / Items not in prompt delivery. Please contact the commercial department to check availability.

Maniglie / Handles

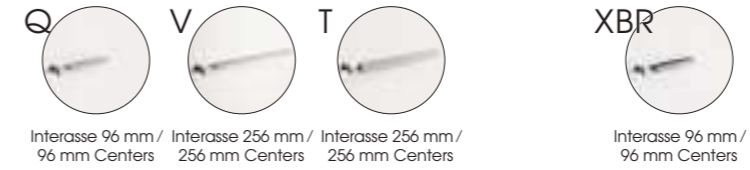
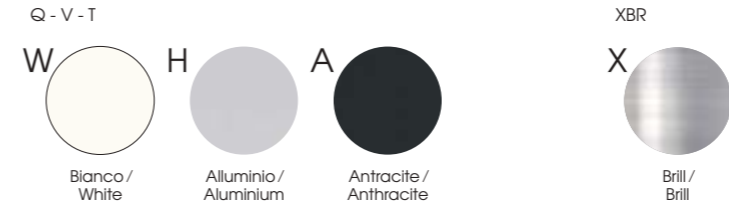

Dati tecnici / Technical data

Cassettiere / Pedestals

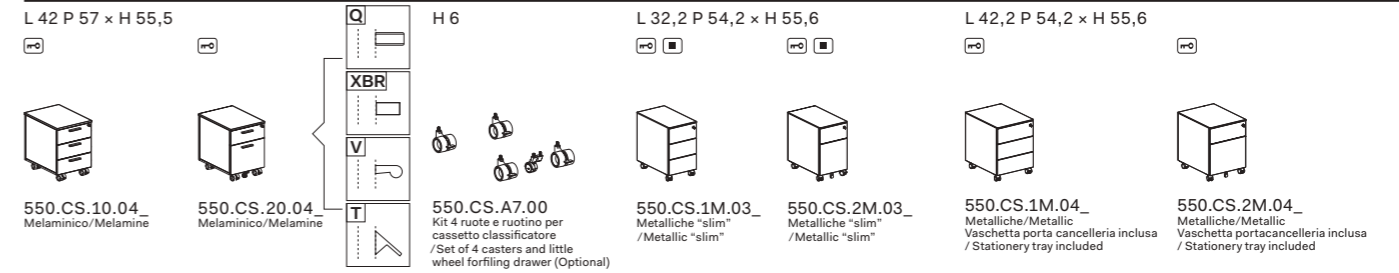

Cassettiere portanti / Carrying pedestals

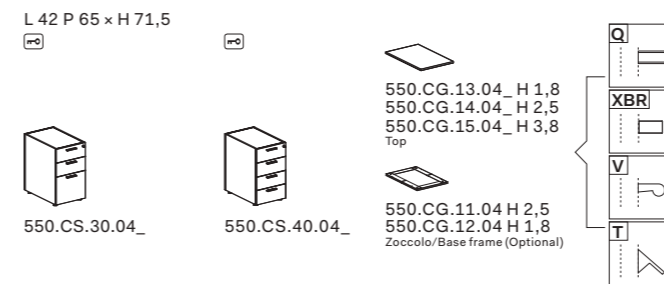

Mobile di servizio su ruote / Service unit on castors

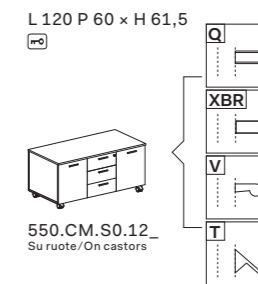

Accessori per cassettiere e contenitori / Accessories for pedestals and storage units



Note:

Le dimensioni sono espresse in cm - consultare il listino prezzi per le caratteristiche tecniche, i codici degli articoli e delle finiture / Dimensions are stated in cm - for technical characteristics, article code numbers and finishing see price list;

Prodotti non in pronta consegna. Per la disponibilità contattare l'ufficio commerciale / Items not in prompt delivery. Please contact the commercial department to check availability;

Con serratura / With lock.

Accessories

Le dotazioni che fanno la differenza. Una vasta gamma di prodotti, componenti e accessori di arredo per ufficio, per incontrare le più diverse esigenze e personalizzare le vostre idee.

Equipment that makes a difference. A wide range of products, components and office furniture accessories, to meet the most diverse needs and customize your ideas.

Frontal panels P. 522



Screens P. 528



Coffee tables P. 534



Wire-management P. 540



Byblos P. 548



Complements P. 554



Acoustic complements P. 566



Frontal panels DV300

Per incontrare le più diverse esigenze, per amplificare la funzionalità e la personalizzazione delle nostre linee, abbiamo creato una serie di accessori coordinabili, sempre disponibili a magazzino, in grado di completare ogni arredo.

To satisfy the most different needs, to boost the functionality and customization of our series, to complete any furniture unit, we created a range of matching accessories, always available in stock.







Vasta gamma di frontal panels in diversi materiali: melaminico, vetro, tessuto anti-batterico etc.

Wide range of frontal panels in different materials: melamine, glass, anti-bacterial fabric etc.



Screens

DV300

Speciali barriere protettive dedicate agli operatori e a tutti coloro che, per attività lavorative, sono a contatto diretto con il pubblico. Questa collezione, oltre agli schermi in plexiglass trasparente, dispone di pannelli a pavimento e divisori in melaminico o laminato.

Special protective barriers intended for operators and to all those who are in direct contact with the public for their activities. This collection, in addition to the transparent plexiglass screens, offers floor panels and partitions in melamine or laminate.





Tutti gli screens
in melaminico e
plexiglass sono
riciclabili al 100%.



*All screens in
melamine and
plexiglass are
100% recyclable.*

Coffee tables

DV300

Famiglia di tavolini caffè e attesa con diverse varianti di piani, gambe e materiali anche di prestigio come il "gres". Adattabili ad ogni tipo di esigenza, situazione e contesto per creare soluzioni d'arredo innovative e sorprendenti.

Family of coffee and waiting tables with different variants of tops, legs and materials, including prestigious materials such as "gres". Adaptable to any type of need, situation and context to create innovative and surprising furnishing solutions.







Wire management DV300

Grande importanza è data all'elettificazione delle postazioni. Canali passacavi e ribalte, carters e innumerevoli accessori sono gli elementi di un sistema funzionale che risponde all'evoluzione del lavoro.

Great importance is given to electrification of the workstations. Cable ducts and flaps, carters and countless accessories are the elements of a system functional that responds to the evolution of work.



Canale passacavi attrezzabile e passacavi verticale a spirale.

Equippable wire management and vertical spiral cable duct.



Top access con sportello apribile su due lati / Top access with door opening on both sides



Top access elettrificato per piano scrivania / Wired top access for desk



A lato:
braccio porta video
statico su palo con
fissaggio su
binario centrale.

*To the side:
static arm for video
support on pole
with fixing on
central rail.*

Sopra:
canale passacavi in
tondino di acciaio
verniciato colore
alluminio.

*Above:
cable channels
made of embossed
aluminium
coloured.*

Sotto:
Top access in
alluminio con
sportello apribile.

*Under:
Top access aluminium
coloured with opening
door.*

A lato:
Kit fissaggio lampada
Talak decentrata
su profilo doppio
attrezzabile.

*To the side:
Talak lamp fixing
device for offset
position on double
profile to be equipped.*



Byblos

DV300

Originale lampada a Led integrabile a molteplici nostre serie di tavoli sia direzionali che operativi. Struttura in alluminio e diffusore in metacrilato, molto utile per realizzare tavoli biblioteca.

Original Led lamp integrable to many of our series, both in the executive and workstations. Aluminum frame and methacrylate light diffuser, very useful for creating library desks.

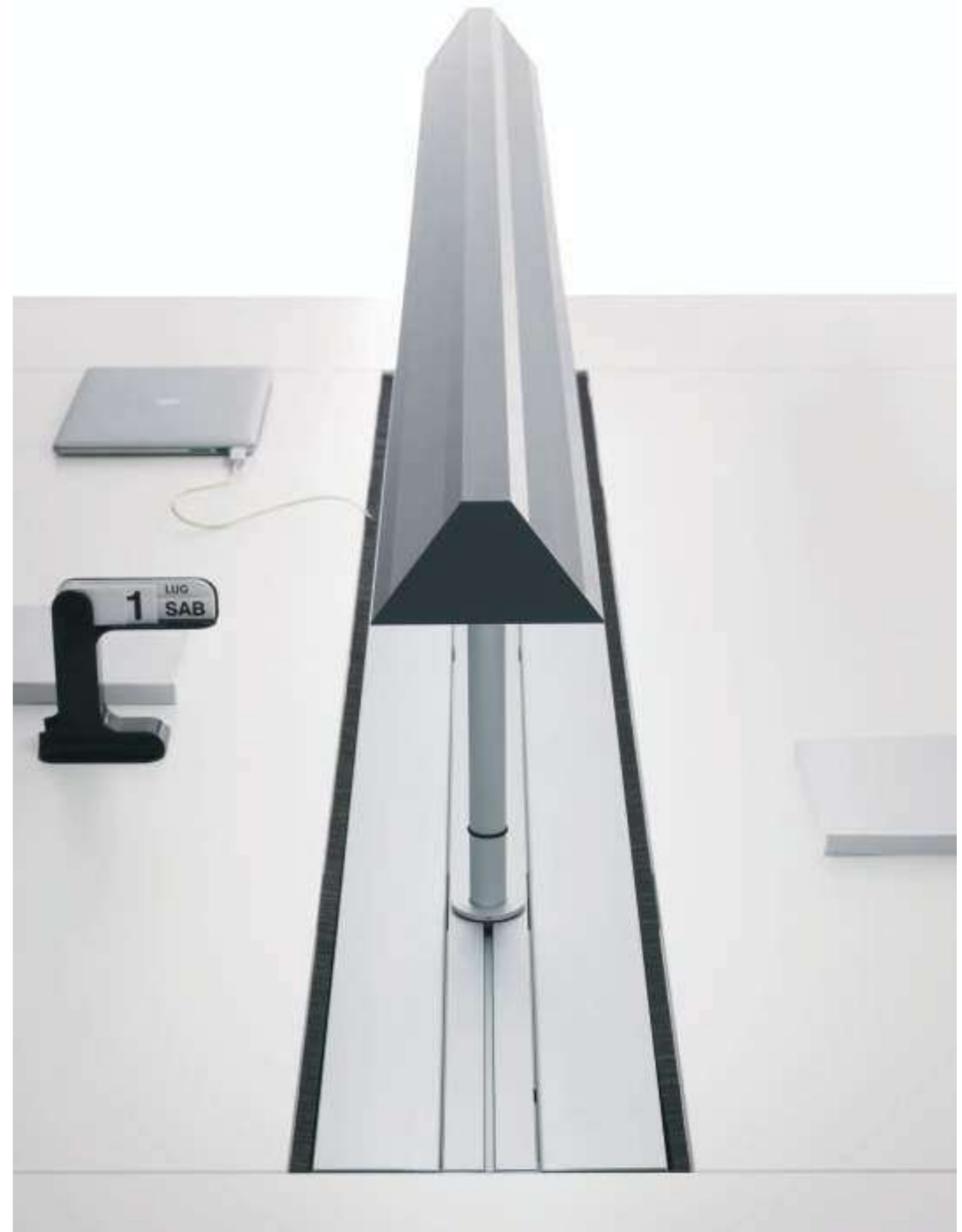





Complements DV300

Le dotazioni che fanno la differenza. Per incontrare le più diverse esigenze, per amplificare la funzionalità e la personalizzazione delle nostre linee, abbiamo creato una serie di accessori coordinabili, sempre disponibili a magazzino, in grado di completare ogni arredo.

Equipment that makes a difference. To satisfy the most different needs, to boost the functionality and customization of our series, to complete any furniture unit, we created a range of matching accessories, always available in stock.





Portadox in lamiera bianco / Binder holder in white sheet metal



Box multiuso / Storage box



Contenitore pensile chiuso / Closed hanging storage



Porta CPU su ruote / CPU holder on castors



Porta CPU sospeso con cinghie, serie DV804 E-PLACE (per le altre serie vedi relativi cataloghi) / CPU holder suspended with straps series DV804 E-PLACE (for other series see relevant catalogs)



Contenitore pensile aperto / Open hanging storage



Dettaglio chiave / Key detail



Mensole con supporti / Shelves with brackets



Presse USB sottopiano (2 prese USB, solo ricarica) / Under-worktop USB socket (2 USB socket, charger only)



Porta penne e mensola in metallo bianco / White metal pen holder and shelf



Tavolo su ruote, accatastabile orizzontalmente, con piano ribaltabile / Desk on castors, stackable horizontally, with foldable worktop



Tavolo regolabile con sistema pneumatico a pedale / Height adjustable tables with pneumatic pedal

Frontal panels in vetro stratificato sp. 0.8 cm / Glass frontal panels stratified glass 0.8 cm thick



Frontal panels in melaminico / Melamine frontal panels

Frontal panels sp. 1 cm, in melaminico con bordo ABS sp. 0.15 cm colore alluminio / Frontal panels 1 cm thick, in melamine with aluminium-coloured ABS edge-profile 0.15 cm thick



Frontal panels in tessuto acustici / Acoustic fabric frontal panels

Rivestimento in tessuto 100% poliestere Trevira CS - JET Bioactive / 100% polyester Trevira CS - JET Bioactive fabric coating

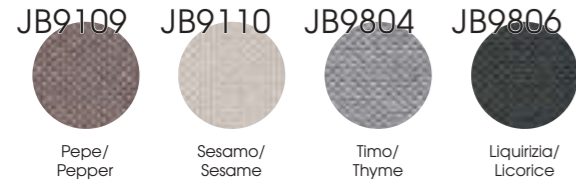

Morsetti e supporti / Clamps and supports

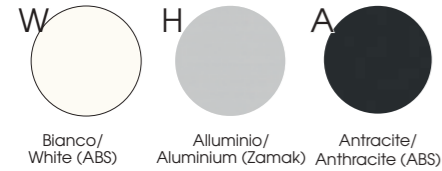

Accessori per Frontal panels / Accessories for Frontal panels



Screens - Frontal panels

Plexiglass sp. 0.5 cm / 0.5 thick



Paretine (Base solo alluminio) / Partitions (Base only aluminium)

Pannello in melaminico o laminato **, sp. 1.8 cm / 1.8 cm thick, panel in melamine or laminate **



Portapenne in metallo per paretine / Metal pen holder for partitions



Tavolini caffè universali / Universal coffee tables

Piani di lavoro sp. 2.5 cm, in melaminico / Worktops 2.5 cm thick, in melamine

Piani di lavoro realizzati in MDF sp. 2.5 cm accoppiato con piano in gres porcellanato, sp. 0.6 cm / Worktops made of 2.5 cm thick MDF coupled with a 0.6 cm thick top in porcelain stoneware



Gambe in legno / Wooden legs



Gambe metalliche / Metal legs



Gambe metalliche / Metal legs (E-Place)

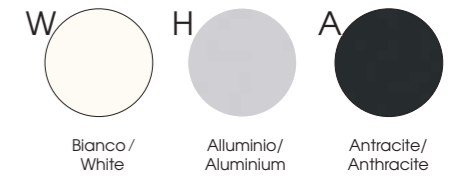

Byblos - Lampada led in alluminio / Aluminium Led lamp



Tavoli con piano ribaltabile / Tables with folding worktop

Piani di lavoro sp. 2.5 cm, in melaminico con bordi in ABS sp. 0.2 cm / Worktops 2.5 cm thick, in melamine with ABS edge-profiles 0.2 cm thick



Strutture metalliche / Metal structures

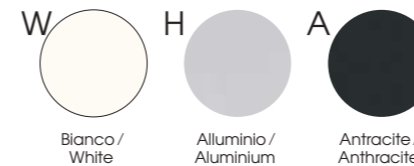

Modesty panel in tessuto / Fabric modesty panel



Note

Prodotti non in pronta consegna. Per la disponibilità contattare l'ufficio commerciale / Items not in prompt delivery. Please contact the commercial department to check availability
Per tutte le altre finiture consultare i relativi capitoli all'interno del listino prezzi. / For all other finishes, please refer to the relevant chapters in the price list.

Frontal panels Sp. 0,8 - 1

P 1 x H 39 P 0,8 x H 39

300.FP.06.06_L 64
300.FP.06.07_L 79
300.FP.06.09_L 99
300.FP.06.11_L 119
300.FP.06.13_L 139
300.FP.06.15_L 159
300.FP.06.17_L 179
300.FP.06.19_L 199

Melaminico/Melamine

Frontal panel fonoassorbenti Sp. 3 / Acoustic frontals panels T. 3

P 3 x H 39 P 3 x H 59 P 3 x H 39

300.FP.40.06_L 64
300.FP.40.07_L 79
300.FP.40.09_L 99
300.FP.40.11_L 119
300.FP.40.13_L 139
300.FP.40.15_L 159
300.FP.40.17_L 179

Tessuto/Fabric

Frontal panels con supporti integrati / Frontal panels with clamps

L 77 P 1 x H 39 L 77 P 1 x H 39

300.FR.19.07_ Per piani melaminico / For worktops melamine

Frontal panels H 65 con supporto freestanding integrato / Frontal panels with freestanding bracket integrated

L 77 P 18 x H 65 L 77 P 18 x H 65 L 77 P 18 x H 65 L 77 P 18 x H 65

300.FR.20.07_ Melaminico / Melamine
300.FR.20.07_ Melaminico / Melamine
300.FR.21.07 Plexiglass
300.FR.21.07 Plexiglass

Frontal panels H 65

P 1 x H 65 P 0,5 x H 65

300.FP.09.06_L 64
300.FP.09.07_L 79
300.FP.09.09_L 99
300.FP.09.11_L 119
300.FP.09.13_L 139
300.FP.09.15_L 159
300.FP.09.17_L 179
300.FP.09.19_L 199

Melaminico/Melamine

* N.B.: Per i frontal con lunghezza maggiore o uguale ai 139 cm, ordinare 2 kit di supporti per frontal panel / Note: For frontal panels with a length greater than or equal to 139 cm, order 2 kits of clamps-supports for frontal panels

Accessori per frontal panels in melaminico/Accessories for melamine frontal panels

L 6,5 P 6,5 x H 8,5 L 50 P 17 x H 3 L 31 P 22 x H 5 L 23 P 10 x H 29 L 35 P 6,5 x H 30

300.FA.01.01 300.FA.02.05 300.FA.04.03 300.FA.06.02 300.FA.08.03

Note: Il posizionamento degli accessori sui frontal panel in vetro prevede l'utilizzo di una guarnizione in PVC trasparente (Optional su richiesta) / Placement of accessories on glass front panel need the use of a trasparente PVC gasket (Optional on request)
Non utilizzabile su frontal panels in plexiglass e frontal panels in tessuto fonoassorbente / Not usable for plexiglass frontal panels and acoustic frontal panels

Morsetti e supporti in ABS per frontal panels Sp. 0,5 - 0,8 - 1 - 3 / ABS clamps for frontal panels T. 0,5 - 0,8 - 1 - 3

300.FP.27.00 Per piani/For worktops
300.FP.29.00 Per gamba (serie DV801 e DV802) / For leg (series DV801 and DV802)
300.FP.32.00 Per piano-gamba (serie DV801 e DV802) / For worktop-leg (series DV801 and DV802)
300.FP.30.00 Per gamba (serie DV805) / For leg (serie DV805)
300.FP.31.00 Per piano-gamba (serie DV805) / For worktop-leg (serie DV805)
300.FP.28.00 Per piani-binari / For worktops-track
300.FP.33.00 Free standing per piani / Free standing for worktops

Per frontal panels/For frontal panels

Morsetti e supporti in ZAMA per frontal panels Sp. 0,5 - 0,8 - 1 - 3 / Zamak clamps for frontal panels T. 0,5 - 0,8 - 1 - 3

300.FP.10.00 Per piani/For worktops
300.FP.20.00 Per gamba (serie DV801 e DV802) / For leg (series DV801 and DV802)
300.FP.21.00 Per piano-gamba (serie DV801 e DV802) / For worktop-leg (series DV801 and DV802)
300.FP.23.00 Per gamba (serie DV805) / For leg (serie DV805)
300.FP.24.00 Per piano-gamba (serie DV805) / For worktop-leg (serie DV805)
300.FP.22.00 Per piani-binari / For worktops-track
300.FP.33.00 Free standing per piani / Free standing for worktops
300.FP.26.00 Per FP 1; Per profilo attrezzabile (serie DV801) / For FP 1; For accessory profile (serie DV801)

Per frontal panels/For frontal panels

Note:

1 Le dimensioni sono espresse in cm - consultare il listino prezzi per le caratteristiche tecniche, i codici degli articoli e delle finiture/Dimensions are stated in cm - for technical characteristics, article code numbers and finishing see price list;

2 Prodotti non in pronta consegna. Per la disponibilità contattare l'ufficio commerciale/Items not in prompt delivery. Please contact the commercial department to check availability;

A Morsetti o supporti in ABS / ABS clamps
Z Morsetti o supporti in ZAMA / Zamak clamps
P Plexiglass
V Vetro/Glass.

Screens in plexiglass / Plexiglass screens

L 80 P 28 x H 80 L 100 P 28 x H 80 L 100 P 24 x H 66

300.FP.67.08 Plexiglass
300.FP.67.10 Plexiglass
300.FR.22.10 Plexiglass

Partitions

L 90 P 30 x H 180 L 90 P 35 x H 180

300.EM.07.00_ Melaminico o laminato bianco lucido / Melamine or polished white
300.EM.08.00_ Melaminico o laminato bianco lucido / Melamine or polished white
Su ruote / On wheels

Accessori per partizioni / Accessories for partitions

L 7 P 7 x H 9

300.FA.09.01 Portapenne / Pen holder

Frontal panels a pavimento / Floor frontal panels

L 130 P 18 x H 140 L 130 P 18 x H 140

300.FR.23.13_ Melaminico / Melamine
300.FR.23.13_ Melaminico / Melamine

Tavolini caffè universali / Universal coffee tables

Ø 60 x H 45 Ø 60 x H 45 Ø 60 x H 45 Ø 60 x H 45 Ø 60 x H 74 Ø 60 x H 74 Ø 60 x H 74

300.TT.04.06_ Con gambe metalliche / With metal legs
300.TT.04.06_ Con gambe metalliche / With metal legs
300.TT.04.06_ Con gambe metalliche / With metal legs
300.TT.04.06_ Con gambe metalliche / With metal legs
804.TR.20.06_ Con gambe freestanding DV804 / With freestanding legs DV804
804.TR.20.06_ Con gambe freestanding DV804 / With freestanding legs DV804
300.TR.20.06_ Con gambe coniche in legno / With wooden conic legs

Ø 60 x H 74 L 100 P 100 x H 45 L 100 P 100 x H 45 L 100 P 100 x H 45 L 100 P 100 x H 45 L 100 P 100 x H 74 L 100 P 100 x H 74

300.TR.20.06_ Con gambe coniche in legno / With wooden conic legs
300.TT.05.10_ Con gambe metalliche / With metal legs
300.TT.05.10_ Con gambe metalliche / With metal legs
300.TT.05.10_ Con gambe coniche in legno / With wooden conic legs
300.TT.05.10_ Con gambe coniche in legno / With wooden conic legs
804.TR.31.10_ Con gambe freestanding DV804 / With freestanding legs DV804
804.TR.31.10_ Con gambe freestanding DV804 / With freestanding legs DV804

L 100 P 100 x H 74 L 100 P 100 x H 74

300.TR.31.10_ Con gambe coniche in legno / With wooden conic legs
300.TR.31.10_ Con gambe coniche in legno / With wooden conic legs

Tavolini caffè / Coffee tables

P 60 x H 42,5 P 60 x H 42,5 P 60 x H 45 P 60 x H 45

300.TT.02.06_L 60
300.TT.02.12_L 120
300.TT.03.06_L 60
300.TT.03.12_L 120
300.TV.25.06 L 60
300.TV.25.12 L 120

Gamba a "X" / "X" shaped leg
Gamba a "L" / "L" shaped leg

910.TT.03.06_L 60
910.TT.03.12_L 120







Note:



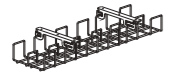



1 Le dimensioni sono espresse in cm - consultare il listino prezzi per le caratteristiche tecniche, i codici degli articoli e delle finiture/Dimensions are stated in cm - for technical characteristics, article code numbers and finishing see price list;
2 Prodotti non in pronta consegna. Per la disponibilità contattare l'ufficio commerciale/Items not in prompt delivery. Please contact the commercial department to check availability;



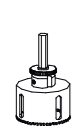

N.B.: Articoli completamente smontati / N.B.: Completely knocked-down
Le partizioni in laminato lucido (WL) possono essere utilizzate come lavagne con gli appositi pennarelli / Polished white laminate (WL) partitions can be used as blackboards with the appropriate markers

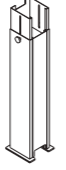





P Plexiglass
A Morsetti o supporti in ABS / ABS clamps
Z Morsetti o supporti in ZAMA / Zamak clamps
G Piani in Gres porcellanato/Worktops in Porcelain stoneware;
V Vetro/Glass.

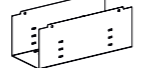



Canalizzazione - Elettrificazione - Accessori/Wire management - Electrification - Accessories

 300.AP.15.04 L 45 300.AP.15.05 L 58 300.AP.15.07 L 78 300.AP.15.08 L 88 300.AP.15.10 L 100 300.AP.15.11 L 110 300.AP.15.14 L 140 300.AP.15.16 L 160	 300.AP.30.02 L 24 300.AP.30.06 L 60 300.AP.30.09 L 90 300.AP.30.11 L 110 300.AP.30.14 L 140 300.AP.30.16 L 160	 300.CL.01.40 L 115	 804.CL.02.01 L 10 804.CL.02.04 L 45 804.CL.02.06 L 65 804.CL.02.08 L 85 804.CL.02.11 L 110	 300.AP.F1.00
 300.AP.20.00 L 57				

 300.AP.U1.01 Ø 6 300.AP.U2.01 Ø 8 300.AP.U3.01 Ø 10,2	 300.AP.T7.01 Ø 6 300.AP.T8.01 Ø 8	 300.AP.V1.00	 300.AP.31.06	 300.AP.V2.15	 300.FA.09.01 Portapenne / Pen holder	 300.AC.33.02
L 32 x P 12,3	P 17,5	L 7 P 7 x H 9	L 24 P 10 x H 1,5			

 300.AC.38.02 H 2,4 300.AC.38.03 H 3	 300.AC.67.03 Marsupio per top access 300.AC.38.02 / Basket for top access 300.AC.38.03	 300.AC.26.02 L 24,5 300.AC.26.03 L 34,5 300.AC.26.04 L 44,5	 300.AC.20.02 L 24,5 300.AC.20.03 L 34,5 300.AC.20.04 L 44,5	 300.AC.25.02 L 23,5 300.AC.25.03 L 33,5 300.AC.25.04 L 43,5 Marsupio/Basket
--	---	--	--	---

 300.AP.S1.02 300.AP.S2.02 UK 300.AP.S3.02 US Per top access 300.AC.26.02 / For top access 300.AC.26.02	 300.AP.S1.03 300.AP.S2.03 UK 300.AP.S3.03 US Per top access 300.AC.26.03 / For top access 300.AC.26.03	 300.AP.S1.04 300.AP.S2.04 UK 300.AP.S3.04 US Per top access 300.AC.26.04 / For top access 300.AC.26.04	 300.AP.T8.11 Tappo con 1 presa elettrica + USB (solo ricarica) + passacavo / Plug with 1 electrical socket + USB (only charge) + outlet lid	 300.AP.T8.14 Tappo con 1 presa elettrica + USB (solo ricarica) + HDMI / Plug with 1 electrical socket + USB (only charge) + HDMI	 300.AP.T8.17 Tappo con 1 presa elettrica + USB (solo ricarica) + RJ45 / Plug with 1 electrical socket + USB (only charge) + RJ45	 300.AP.T8.20 Tappo con 1 presa elettrica + USB (solo ricarica) + USB data + USB (only charge) + USB data
L 20,5	L 30	L 42	Ø 8			

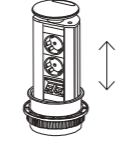
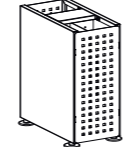
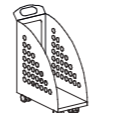
 300.AT.A6.02 300.AT.A7.02 UK 300.AT.A8.02 US	 300.AT.A6.03 300.AT.A7.03 UK 300.AT.A8.03 US	 300.AT.A6.04 300.AT.A7.04 UK 300.AT.A8.04 US	 812.AC.08.01 812.AC.08.01 - UK 812.AC.08.01 - US Presa USB (solo ricarica) / USB Socket (only charge)	 300.AP.T4.01 300.AP.T5.01 UK 300.AP.T6.01 US	 300.AC.16.02	 300.AC.06.05
L 21	L 25,5	L 39	L 5 P 3 x H 5			

Bracci porta video/Arms for video support

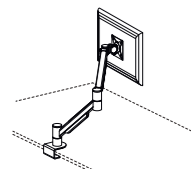
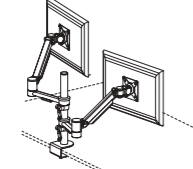
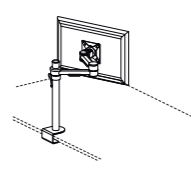
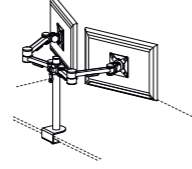
 300.AC.02.01 Braccio porta video mobile su piano / Dynamic arm for video support on deskbase	 300.AC.02.02 Doppio braccio porta video mobile su piano / 2 dynamic arms for video support on deskbase	 300.AC.01.01 Braccio porta video statico su palo / Static arm for video support on pole	 300.AC.01.02 Doppio braccio porta video statico su palo / 2 static arms for video support on pole
--	---	--	--

Note:

1 Le dimensioni sono espresse in cm - consultare il listino prezzi per le caratteristiche tecniche, i codici degli articoli e delle finiture/Dimensions are stated in cm - for technical characteristics, article code numbers and finishing see price list;

2 Prodotti non in pronta consegna. Per la disponibilità contattare l'ufficio commerciale/Items not in prompt delivery. Please contact the commercial department to check availability;

3 Fino ad esaurimento/Until exhaustion.

4 Articoli prodotti solo su richiesta /Items produced only on demand;

Lampade/Lights

L 200 P 14,5 x H 37



300.AC.50.20

Note: Da integrare ai tavoli riunione/To be integrated with meeting tables

Pensile / Overhead unit

L 78 P 35 x H 42

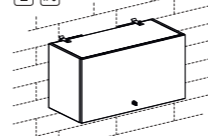

300.AC.75.07

Mensola con supporti/Wall-shelf with supports

P 30 x H 2,5

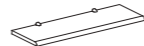

300.AC.M1.09 L 90
300.AC.M1.13 L 130
300.AC.M1.18 L 180

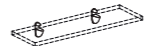

300.AC.M2.00
Coppia ovetti reggi-mensola
/ Pair of egg-shaped wall-shelf support

Contenitori multiuso/Multipurpose units

L 80 P 40 x H 40

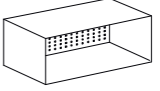



300.AC.15.08
Contenitore porta dox in lamiera
/ Steel top box

L 35 P 24 x H 35



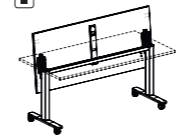

300.AC.14.03
Box multiuso
/ Storage box

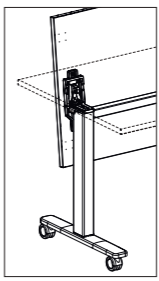
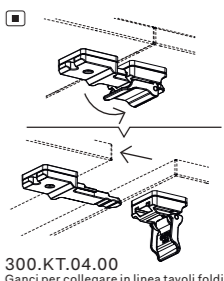
Tavoli su ruote con piano ribaltabile/Tables on castors with flip worktop

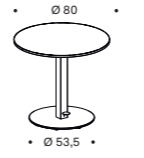
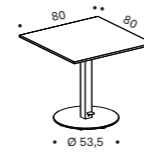
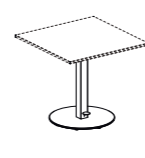

 300.TF.01.08 L 80 300.TF.01.10 L 100 300.TF.01.12 L 120 300.TF.01.14 L 140 300.TF.01.16 L 160 300.TF.01.18 L 180	 300.TF.02.08 L 80 300.TF.02.10 L 100 300.TF.02.12 L 120 300.TF.02.14 L 140 300.TF.02.16 L 160 300.TF.02.18 L 180	 300.MP.10.08 L 46,5 300.MP.10.10 L 66,5 300.MP.10.12 L 86,5 300.MP.10.14 L 106,5 300.MP.10.16 L 126,5 300.MP.10.18 L 146,5 Modesty panel per tavolo con piano ribaltabile / Modesty panel for table with flip worktop	 300.KT.04.00 Ganci per collegare in linea tavoli folding / Hooks to connect folding desks in line
P 70 - H 74	P 80 - H 74	P 1 - H 31	

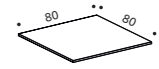
Tavoli su gamboni regolabili/Tables on adjustable metal column

 300.TR.60.08	 300.TR.61.08	 300.TR.62.00	 801.PR.01.08 Ø 80	 801.PR.02.08 L 80
H 69,5 - 113,5			H 1,8	H 1,8 P 80

Note: Regolazione con sistema pneumatico a pedale. Piano in melaminico sp. 18 mm con bordi perimetrali in ABS/Adjustment with pneumatic pedestalsystem. Worktops in melamine 18 mm thick with ABS perimetrical edges

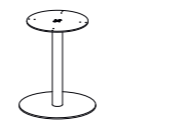
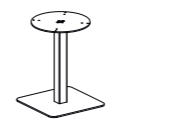
Colonne e gamboni/Metal columns

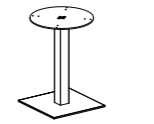
 300.AC.17.06 Ø 60	 300.AC.51.08	 703.GM.01.01 H 71,5 802.GF.05.01 H 72,2	 300.AC.18.04
H 71,5	L 55 P 55 x H 71,5	L 5 x P 5	L 48 P 48 x H 73

Note:

1 Le dimensioni sono espresse in cm - consultare il listino prezzi per le caratteristiche tecniche, i codici degli articoli e delle finiture/Dimensions are stated in cm - for technical characteristics, article code numbers and finishing see price list;

2 Prodotti non in pronta consegna. Per la disponibilità contattare l'ufficio commerciale/Items not in prompt delivery. Please contact the commercial department to check availability;

3 Con serratura/With lock.
4 Fino ad esaurimento/Until exhaustion.

5A Gambone in alluminio anodizzato / Metal column made in "Anodized" aluminium;
5B Gambone verniciato a polveri in bianco, alluminio o antracite / Metal column electrostatic painted in white, aluminum or anthracite;

Acoustic Complements DV300

Sistema di oggetti pensati e progettati per funzionare in maniera sinergica con l'attore principale dell'ufficio: il soggetto. Tutto ruota intorno alla figura del soggetto, ai suoi spazi, ai suoi tempi e alle sue specifiche necessità umane e lavorative.

System of objects conceived and designed to work synergistically with the main actor of the office: the subject. Everything revolves around the figure of the subject, his spaces, his times and his specific human and work needs.







Oltre ai molteplici Frontal panels la gamma si arricchisce di pannelli modulari fonoassorbenti da parete o soffitto a tema esagonale (Wall), assieme ad un sistema modulare di pannelli fonoassorbenti sospesi o per controsoffitto (Ceiling).

In addition to the multiple Frontal panels the range is enriched with modular wall or ceiling sound-absorbing panels with a hexagonal theme (Wall), together with a modular system of suspended or false ceiling sound-absorbing panels (Ceiling).



Frontal panels, pannelli wall, Ceiling sospesi in tessuto fonoassorbente / Acoustic fabric frontal panels, wall panels and suspended ceiling panels

Rivestimento in tessuto 100% poliestere Trevira CS - JET Bioactive / 100% polyester Trevira CS - JET Bioactive fabric coating

JB9109 JB9110 JB9804 JB9806

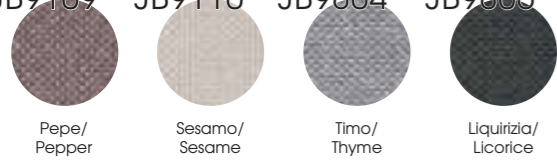

Pannelli ceiling in tessuto fonoassorbente per controsoffitto / Acoustic fabric ceiling panel for suspended ceiling

Rivestimento in poliestere / Polyester coating

532 569 573 629 999

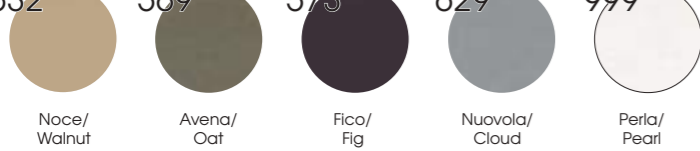

Morsetti e supporti conici / Clamps and cone clamps

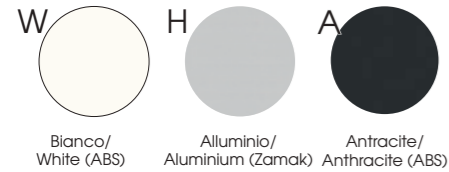

Frontal panel fonoassorbenti sp. 3 cm / Acoustic frontals panels 3 cm thick

P 3 x H 39

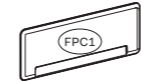

300.FP.40.06_L 64
300.FP.40.07_L 79
300.FP.40.09_L 99
300.FP.40.11_L 119
300.FP.40.13_L 139
300.FP.40.15_L 159
300.FP.40.17_L 179
Tessuto/Fabric

P 3 x H 59



300.FP.50.13_L 139
300.FP.50.15_L 159
Tessuto/Fabric

Frontal panel per profilo attrezzabile DV801 / Frontal panel for accessories profile DV801

P 3 x H 39

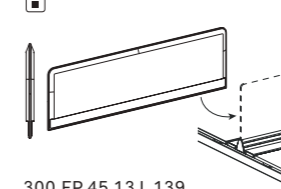

300.FP.45.13 L 139
300.FP.45.15 L 159
Frontal panel per profilo attrezzabile DV801 / Frontal panel for accessories profile DV801

Frontal panel speciali/Special frontal panels

P 2,8 H 30 x L 79,7



300.FR.10.08

P 2,8 H 42,5 x L 139,7



300.FP.60.14

Morsetti e supporti per frontal panels sp. 3 cm / Clamps for frontal panels 3 cm thick [A]

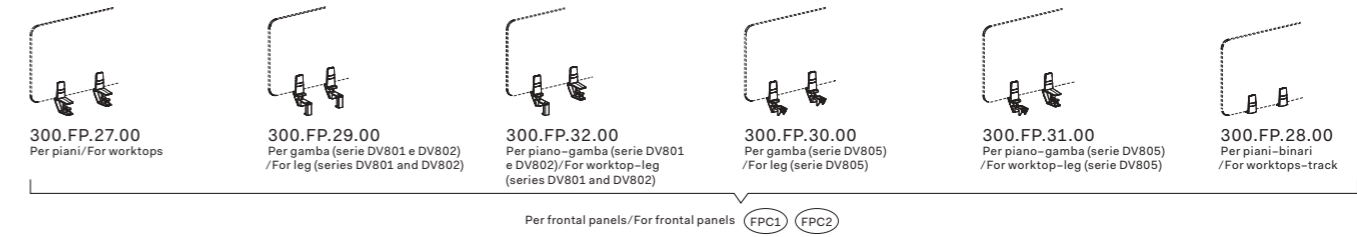

Morsetti e supporti in ZAMA per frontal panels Sp. 3 / Zamak clamps for frontal panels T. 3 [Z]

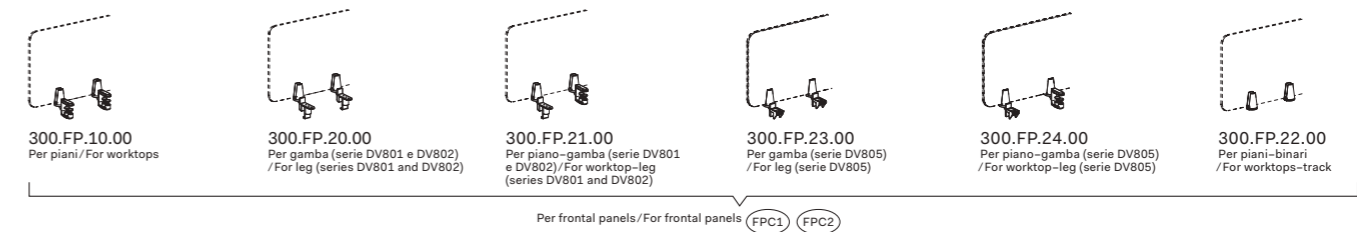

Pannello ceiling sospeso / Suspended ceiling panel

L 60 x H 60

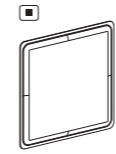

300.PC.05.01

P 3 H 23 x L 70

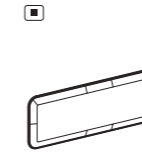

300.PC.07.01

Kit per ceiling sospeso / Kit for suspended ceiling

■

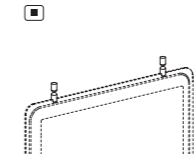

300.KT.05.00
Variante per fissaggio a soffitto / Ceiling fixing variant

■

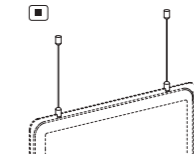

300.KT.05.00
Variante per fissaggio a soffitto con cavi / Ceiling fixing variant with cables

Pannello ceiling per controsoffitto / Ceiling panel for suspended ceiling

L 60 x H 60

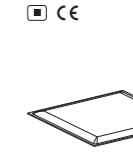

300.PC.06.01

Pannelli wall/Wall panels

L 70 x H 57



300.PC.03.01
Concavo/Concave

L 70 x H 57

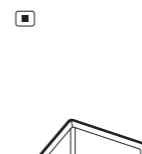

300.PC.04.01
Convesso/Convex

Note
Per tutte le altre finiture consultare i relativi capitoli all'interno del listino prezzi. / For all other finishes, please refer to the relevant chapters in the price list.

Note:
[1] Le dimensioni sono espresse in cm - consultare il listino prezzi per le caratteristiche tecniche, i codici degli articoli e delle finiture / Dimensions are stated in cm - for technical characteristics, article code numbers and finishing see price list;
[■] Prodotti non in pronta consegna. Per la disponibilità contattare l'ufficio commerciale / Items not in prompt delivery. Please contact the commercial department to check availability;
[A] Morsetti o supporti in ABS / ABS clamps
[Z] Morsetti o supporti in ZAMA / Zamak clamps

dvo_

DVO S.R.L. con unico socio
Via XX Settembre, 272
Casella Postale n. 65
U.P. Roveredo in Piano
33080 Roveredo in Piano (PN)
Italy

Tel. +39 0434 386 111
Fax +39 0434 386 112
www.dvo.it
info@dvo.it

Graphic Design
dvo_uff_mkt

Print
Grafiche Antiga

Printed in Italy
Issue 01
November 2021



Foto e testi copyright
DVO non riproducibili.
La venditrice si riserva
la facoltà di apportare
al prodotto eventuali
modifiche tecniche,
dimensionali ed estetiche
in qualsiasi momento
senza preavviso.

Pictures and text are
DVO copyright, duplicate
forbidden. The selling
Company reserves the
right to introduce changes
to products regarding
sizes and aesthetical
or technical aspects at
any timewithout notice.



C/COLLECT/202201

DVO S.R.L. - AZIENDA CERTIFICATA / CERTIFIED COMPANY



Richiedi i prodotti certificati FSC® / Request for FSC® certified products

Il marchio della
gestione forestale
responsabile

dvo_

DVO S.R.L. con unico socio
Via XX Settembre, 272
Casella Postale n. 65
U.P. Roveredo in Piano
33080 Roveredo in Piano (PN)
Italy

Tel. +39 0434 386 111
Fax +39 0434 386 112
www.dvo.it
info@dvo.it

